

NO. 39

\$2.50

AUGUST 1981

MICRO™

THE 6502/6809 JOURNAL

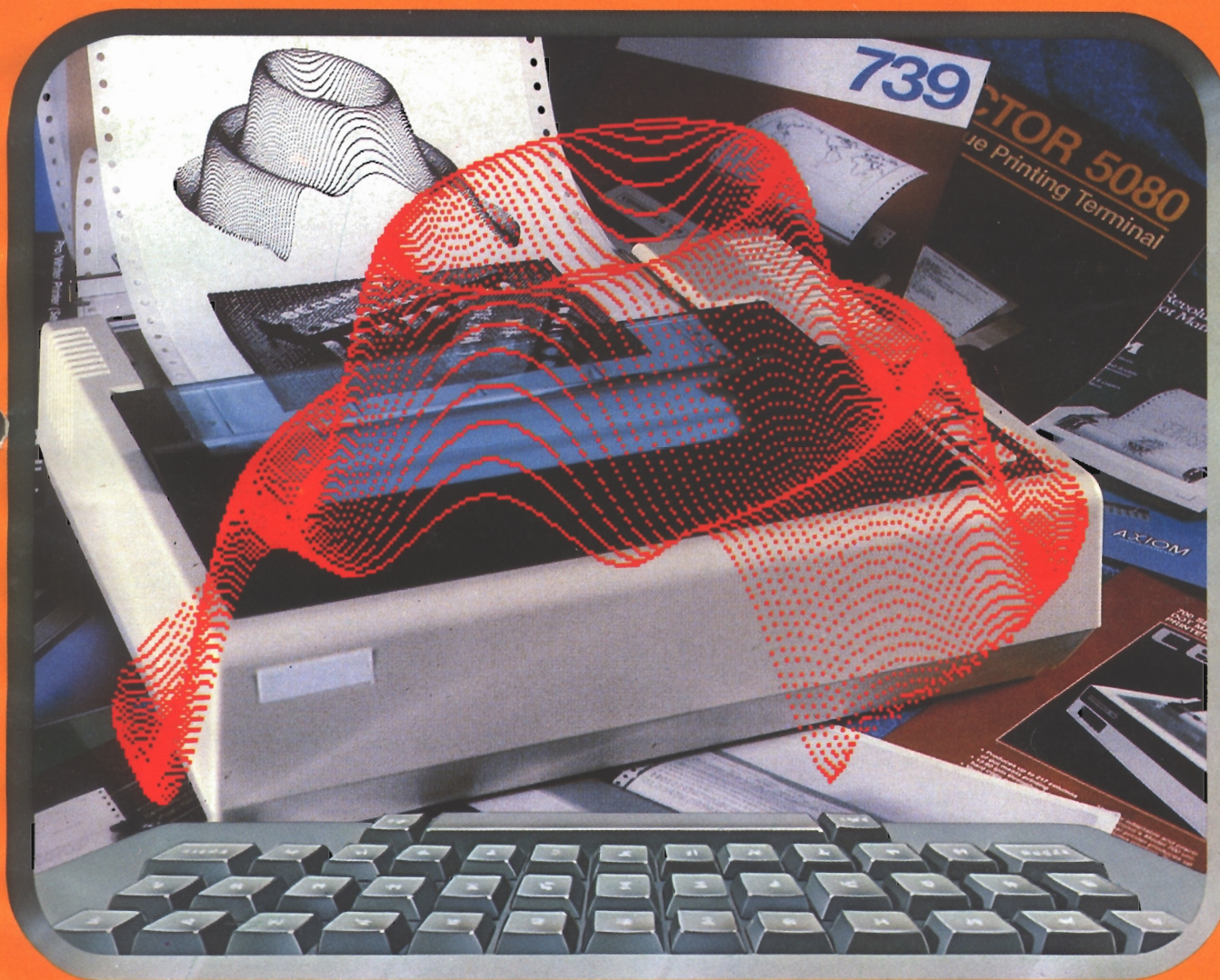

Printer bonus section

Apple bonus section

Expanding the Superboard

Microcrunch, Part 1

Improved *n*th Precision

Disassembling to Memory on AIM 65

You can use MICRO PLUS™ as a

SINGLE BOARD COMPUTER

OEM BUILDING BLOCK

INTELLIGENT TERMINAL

SOPHISTICATED SYSTEM

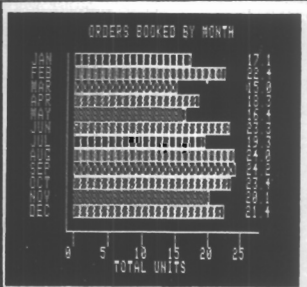
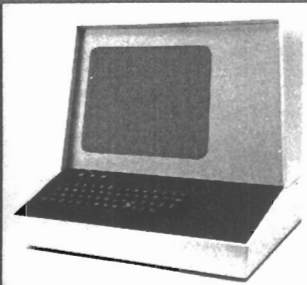
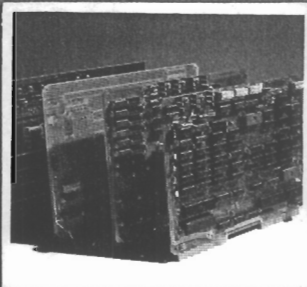
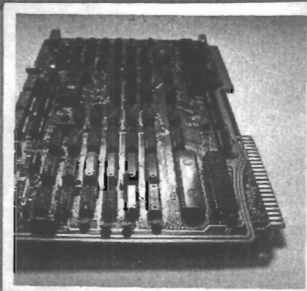

MICRO PLUS is a 6502-based **Single Board Computer** with extensive video capabilities, communications support and keyboard interface. As an **OEM Building Block**, it allows selection of the keyboard, monitor, enclosure and power supply best suited to your application. As an **Intelligent Terminal**, it provides full RS232 and 20 mA communication at baud rates from 50 to 19.2K, with superior text-editing features. It may be combined with FLEXI PLUS to form a **Sophisticated System** with 8" and 5 1/4" diskettes, an IEEE-488 controller, numerous I/O ports, up to 56K memory, and an optional 6809 microprocessor.

Video Features:

- Programmable screen format up to 132 characters by 30 lines
- Reverse video on character-by-character basis
- EPROM character set for user-definable characters
- RAM character set for dynamically changing characters under program control
- Light pen input
- Programmable character width
- Up to 4K display memory

Communications Features:

- Programmable baud rates from 50 to 19.2K baud
- Parity generation and checking
- Programmable word length and stop bits
- Full-duplex or half-duplex operation
- Both RS232C and 20-milliamp current loop interfaces provided
- ASCII keyboard interface

Monitor Features:

- Memory examine and modify
- Auto-increment mode
- Single-step
- Break at specified address
- Break on specified op code

Editor Features:

- Cursor up, down, left, right, home
- Scroll up/down
- Insert/delete line or character
- Fill/clear line or window
- Find character
- Set/clear window limits

System Features:

- Up to 7K RAM—4K display RAM, 2K programmable character generator RAM (which may be used for program RAM), 1K program RAM
- MicroMon 2 operating system software in EPROM
- Can be directly expanded with DRAM PLUS, FLEXI PLUS and PROTO PLUS
- Single voltage required +5V

Call or write for free catalog.
Let us build your custom system.

THE COMPUTERIST®
34 Chelmsford St., Chelmsford, MA 01824
617/256-3649



MICRO PLUS TCB-111	\$375
Communications option	50
Documentation	10

For US, add \$3.00 surface postage. Prices quoted are for US only. For foreign shipments write for rates. Massachusetts residents add 5% sales tax.

EXPAND ENHANCE

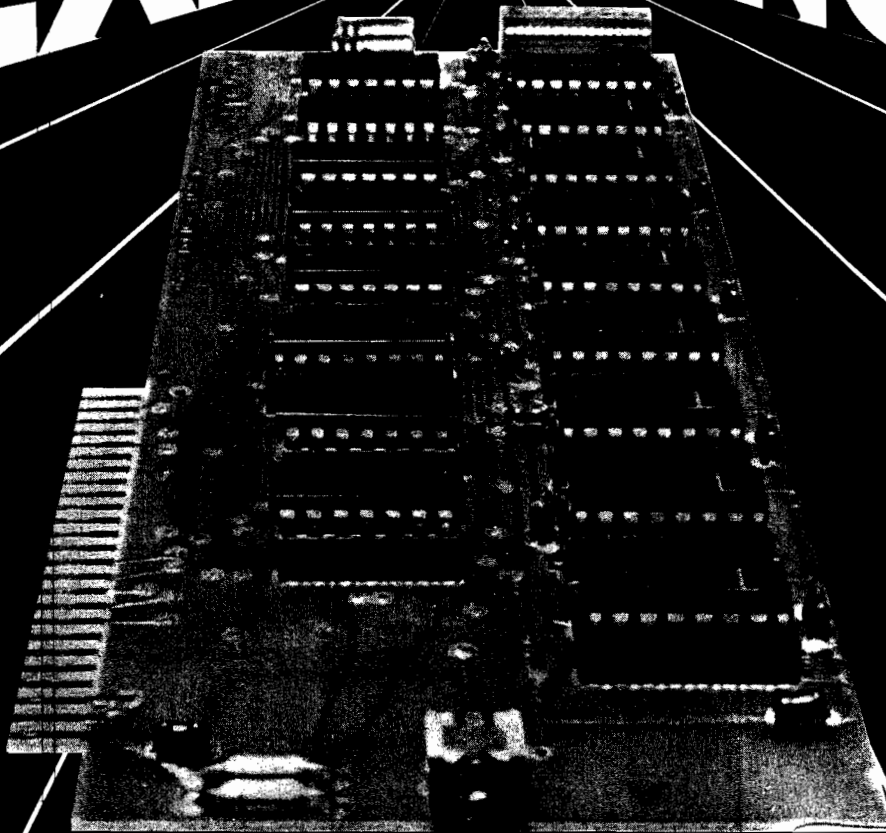

16K RAM EXPANSION BOARD FOR THE APPLE II* \$195.00

The Andromeda 16K RAM Expansion Board allows your Apple to use RAM memory in place of the BASIC Language ROMs giving you up to 64K of programmable memory. Separate Applesoft* or Integer BASIC ROM cards are no longer needed. The 16K RAM Expansion Board works with the Microsoft Z-80 card, Visicalc, DOS 3-3, Pascal, Fortran, Pilot, and other software. A switch on the card selects either the RAM language or the mainboard ROMs when you reset your Apple.

The Andromeda 16K RAM Expansion Board has a proven record for reliability with thousands of satisfied customers.

Now with One Year Warranty.

*Apple II and Applesoft are trademarks.

ANDROMEDA



INCORPORATED

P.O. Box 19144
Greensboro, NC. 27410
919 852-1482

Distributed By:



P.O. Box 696
Amherst, NH. 03031
603 673-7375

the BEST keyboard buffer

Lazer

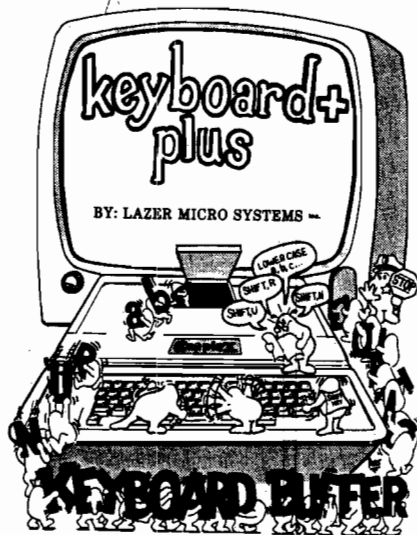

\$119.95

- + More buffer than others.
- + Clear buffer control.
- + SHIFT key entry of upper/lower case.
- + Easy CTL key access to special chars " _ ' { } ~ \ | \ " .
- + Allows BASIC programs with standard INPUT to support Lower Case without software modification.

◁ AND ▷

Separately, they have more features and out perform all the rest. But together as a team they perform even better. Look for the Graphics +Plus soon. It's a RAM based character generator to complement the Lower Case +Plus. It will allow you to define the character set to your needs. You could load German, French, Scientific, Engineering or any other special characters into the Graphics +Plus and use it as if the Apple II was designed specially for that application. And that's not all. If you define the characters as graphics, you can do extremely fast HI-RES type graphics on the text screen without all those cumbersome and slow HI-RES routines and 8K screen. For all the details on this triad of products, send for our free booklet "Lower case adapters and keyboard buffers from the inside out". This booklet gives all the details about lower case adapters and keyboard buffers in general. It also has a section on the Graphics +Plus (RAM based character generator).

the BEST lower case adapter

Lazer



GRAPHICS & LOWER CASE CHARACTER GENERATOR FOR THE APPLE II COMPUTER

\$69.95

- + Normal & Inverse Lower Case.
- + 2 complete character sets on board.
- + Graphics character font built in.
- + Expansion socket allows access to external character sets.
- + 2716 EPROM compatible char generator.
- + More supporting software. (on diskette)
- + Keyboard +Plus & Graphics +Plus designed around the Lower Case +Plus.

Lazer
MICRO SYSTEMS INC.
1791-G Capital
Corona, CA 91720
(714)735-1041

the Keyboard +Plus the Lower Case +Plus

The Keyboard +Plus is a multi-purpose input device for your Apple II. The first thing the Keyboard +Plus will do for you is save you lots of time. When the old adage "time is money" being more true than ever, you naturally want to know how this device can save you and your employees time. We'll start with the input buffer. With the normal Apple II, you can only input data when the computer is ready for it. Not when the disk drive is running or when a printer without buffer is operating, not when Applesoft is performing the FRE(0) function and not when the Apple is off performing time consuming multiple calculations. Sometimes these time (takers) take only a brief time and sometimes they take a long time. Even if they only take a brief time, the operator can lose his train of thought and have to re-orient himself to get back to speed. With the Keyboard +Plus' buffer, the operator can keep right on typing. The buffer will store up all those keystrokes until the computer comes back and requests another input. In most conditions, you will never be more than 2 or 3 keystrokes ahead of the computer. At most, you will probably never have much more than 35 or 40 characters ahead. The Keyboard +Plus has room for 64 characters to be stored, which is far more than you will probably need. The second timesaver the Keyboard +Plus has to offer is the SHIFT Key control of upper/lower case entry. You no longer have to re-orient yourself from the typewriter style keyboard and the Apple II keyboard every time you switch from one to the other. The frustration of the difference without the Keyboard +Plus is worth the cost alone. There are other benefits such as CTRL key entry of all the special character you could not access before and a lot of the Apple keyboard bounce (getting two characters for one stroke) will disappear. Besides these features, there is a keystroke command to clear the buffer as well as RESET key protection for the older Apples. With all these features, it's no wonder that Lazer MicroSystems is becoming known as the company that puts thought into all their products.

The Lower Case +Plus is a plug in (not I/O slot) device that will allow your Apple II to display lower case and graphic characters on the video text screen. The Lower Case +Plus is compatible with ALL word processors that support lower case. With an optional (extra cost) character generator, it will also allow some word processors, such as Applewriter and the 40 column Easywriter, to display normal upper and lower case on the screen with no software modifications. The Lower Case +Plus is compatible with all software that operates with any other lower case adapter. However, since the Lower Case +Plus has features and capabilities that no other lower case adapter has, there is software available that will operate properly only with the Lower Case +Plus. Maybe that is the reason the Lower Case +Plus has become the leading lower case adapter for the Apple II.

Lazer MicroSystems' products are in computer stores all across the country. However, if you cannot locate one, you can order direct from us.

- * California residents must add 6% sales tax.
- * Master Card & Visa (w/all vital info) welcome.
- * Allow 2 weeks additional for checks to clear.
- * Orders outside U.S.A. add \$15.00 for shipping & handling.

Lower Case +Plus, Keyboard +Plus, and Graphics +Plus are trademarks of Lazer MicroSystems, Inc., Corona, CA.

Apple II and Applewriter are trademarks of Apple Computer, Inc., Cupertino, Calif.

Easywriter is a trademark of Cap'n Software, and produced by Information Unlimited Software, Inc., Berkeley, Calif.

MICRO™

THE 6502/6809 JOURNAL

STAFF

Editor/Publisher
ROBERT M. TRIPP

Associate Publisher
RICHARD RETTIG

Associate Editors
MARY ANN CURTIS
FORD CAVALLARI

Special Projects Editor
MARJORIE MORSE

Art Director
GARY W. FISH

Production Assistant
LINDA GOULD

Typesetting
EMMALYN H. BENTLEY

Advertising Manager
CATHI BLAND

Circulation Manager
CAROL A. STARK

Dealer Orders
LINDA HENS DILL

MICRO Specialists
APPLE: FORD CAVALLARI
PET: LOREN WRIGHT
OSI: PAUL GEFFEN

Comptroller
DONNA M. TRIPP

Bookkeeper
KAY COLLINS

Sales Representative
KEVIN B. RUSHALCO
603/547-2970

DEPARTMENTS

4 Letterbox and Microbes
5 Editorial
14 PET Vet
74 New Publications
80 Hardware Catalog
104 Software Catalog
107 6502 Bibliography
111 Advertisers' Index

ARTICLES

- 7 **MICROCRUNCH: An Ultra-fast Arithmetic Computing System, Part 1** *John E. Hart*
Fast floating point processing on the Superboard II
- 16 **It's Time to Stop Dreaming, Part 3** *Robert M. Tripp*
More information on the 6809
- 20 **Improved *n*th Precision** *Glenn R. Sogge*
Code optimization for small systems
- 25 **Disassembling to Memory with AIM 65** *Larry P. Gonzalez*
Clean up disassembled code with AIM text editor
- 29 **Sorting** *William R. Reese*
A new application of Quicksort applied where individual members cannot be moved
- 66 **Expressions Revealed, Part 2** *Richard C. Vile, Jr.*
BASIC and Pascal programs demonstrate the translation process
- 77 **Common Array Names in Applesoft II** *Steve Cochard*
A new command for Applesoft II
- 86 **Applesoft Error Messages from Machine Language** *Steve Cochard*
Understand and use methods and data needed to utilize Applesoft error messages
- 97 **Expanding the Superboard** *Jack McDonald*
Build your own expansion board for the Superboard

PRINTER BONUS

- 33 **On Buying a Printer** *Loren Wright*
Tips to help you purchase the right printer
- 36 **Using a TTY Printer with the AIM 65** *Larry P. Gonzalez*
Output to a teletype printer without restricting the use of the keyboard
- 40 **A \$200 Printer for C1P and Superboard** *Louis A. Beer*
Hardware modifications and software considerations are presented
- 42 **C1P to Epson MX-80 Printer Interface** *Gary E. Wolf*
A circuit is presented to interface the C1P to a popular printer
- 44 **Utilities for the Paper Tiger 460** *Terry L. Anderson*
BASIC and machine language programs present two utilities
- 53 **PET/CBM IEEE 448 to Parallel Printer Interface** *Alan Hawthorne*
This interface maintains compatibility with PET BASIC CMD and PRINT# commands
- 57 **An Inexpensive Printer for Your Computer** *Michael J. Keryan*
Circuit and software allow a printer to be interfaced to your 6502's parallel I/O port

APPLE BONUS

- 81 **The Extended Parser for the Apple II** *Paul R. Wilson*
This program allows easy control of functions
- 83 **SEARCH** *R.C. Merten*
This utility routine aids in the writing and editing of programs in Integer BASIC
- 88 **Trick DOS** *Sanford M. Mossberg*
Easily use DOS by changing any command to fit your needs
- 92 **Sorting with Applesoft** *Norman P. Herzberg*
An Applesoft BASIC program for a sorting algorithm is presented

MICRO

Letterbox and Microbes

Dear Editor:

As a long-time supporter of the 6800 and 6502 families, (I was one of the first dealers to sell Apple I, OSI Challengers and SWTP M6800 microcomputers), I am glad that MICRO will now cover the 6809. This greatly improved micro offers so many advantages, that new users rave about this chip once they understand it. I am sure your excellent series will encourage many to try it. The SS-50 Bus users are about a year ahead in the understanding and use of the 6809, but I am sure that the Apple, PET/CBM, SYM, KIM, and AIM users will catch up fast. We have to welcome a new group into the fold — the TRS-80 Color Computer users. They not only use the 6809, but they can cable into the SS-50 Bus for expansion, before Radio Shack offers it to them.

The point that I really would like to make is that 6809 is an interim processor. For all its excellence, it is a forerunner to the M68000, which is the microprocessor of the future. The M68000 is so far above anything we use today that we will need all the technical help we can get, to understand it and use its great power. I would like MICRO to not only raise our sights to the 6809, but beyond it to the 68000. Thank you for your excellent magazine.

Stanley Veit

We'd like to take this opportunity to thank everyone who has written. Unfortunately we cannot publish all the letters that we receive. However, your letter has a better chance of being published if you are brief, to the point, and cover only one topic per letter.

Jan Skov of Denmark sent this note:

In MICRO (36:37) you made a disastrous comment. SYM-BASIC does indeed support integer variables. Your mistake is understandable as the manual nowhere mentions %-type variables.

I know that integer variables work because I never bothered to read the manual; I just programmed and assumed. Please tell your readers!

Mark L. Crosby of Washington, D.C., sent this microbe:

In the June issue of MICRO some errors of omission occurred in Alan Hill's article "Amper Search for the

Apple" (37:71). These might be difficult for novice assembly language programmers to figure out.

Although the original program was created with a different assembler, the corrections in figure 1 were done on the Apple Tool Kit Assembler/Editor (by Apple Computer Inc.).

The corrections begin at the section headed "DATA STORAGE."

956D C1 CD D0	ASC	'AMPER-SEARCH'
9570 C5 D2 AD		
9573 D3 C5 C1		
9576 D2 C3 C8		
9579 C1 CC C1	ASC	'ALAN G. HILL'
957C CE A0 C7		
957F AE A0 C8		
9582 C9 CC CC		
9585 C3 CF CD	ASC	'COMMERCIAL RIGHTS'
9588 CD C5 D2		
958B C3 C9 C1		
958E CC A0 D2		
9591 C9 C7 C8		
9594 D4 D3 A0		
9597 D2 C5 D3	ASC	'RESERVED'
959A C5 D2 D6		
959D C5 C4		
959F CB 93	LOC	DFB \$CB,\$93 ; DEALLO-1
95A1 23 92		DFB \$23,\$92 ; SEARCH-1
95A3 44	CHRTBL	DFB \$44 ; D
95A4 53		DFB \$53 ; S
95A5 8D	MSG1	DFB \$8D ; (CR)
95A6 D6 C1 D2		ASC 'VARIABLE'
95A9 C9 C1 C2		
95AC CC C5 A0		
95AF A0 A0 A0	NAME	ASC ' ' ; 16 SPACES
95B2 A0 A0 A0		
95B5 A0 A0 A0		
95B8 A0 A0 A0		
95BB A0 A0 A0		
95BE A0		
95BF 8D		DFB \$8D ; (CR)
95C0 CE CF D4		ASC 'NOT FOUND'
95C3 A0 C6 CF		
95C6 D5 CE C4		
95C9 C0		DFB '@' ; CTRL-L
95CA A0 A0 A0	SV50	ASC ' ' ; 6 SPACES
95CD A0 A0 A0		
95D0 A0 A0 A0	ZPSV	ASC ' ' ; 32 SPACES
95D3 A0 A0 A0		
95D6 A0 A0 A0		
95D9 A0 A0 A0		
95DC A0 A0 A0		
95DF A0 A0 A0		
95E2 A0 A0 A0		
95E5 A0 A0 A0		
95E8 A0 A0 A0		
95EB A0 A0 A0		
95EE A0 A0		

Figure 1

About the Cover

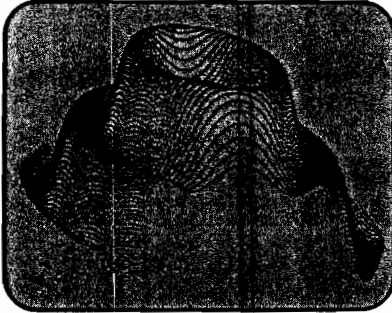

The Printer Revolution

Just as processor technology has exploded in the past several years, so has printer technology. Printers available today offer several times the features of yesterday's printers, at a fraction of the price. The old mechanical monstrosities, so common in computer rooms before the microprocessor boom, could hardly produce a legible, life-long hard copy, let alone a letter-quality output. Now, a new breed of printer, controlled by microprocessor instead of relays, can produce graphical output as well as a variety of printing fonts. Parallel interfaces have enabled these printers to output at much greater speeds than their ancestors. And along with the increase in versatility, quality, and speed, in the past several years we have seen a noticeable decline in price! This decline is due in part to new technologies in thermal and dot-matrix printing, and in part to the commercial popularity of such printers. In this issue, with its special printer section, MICRO salutes the "printer revolution."

MICRO is published monthly by:
MICRO INK, Inc., Chelmsford, MA 01824
Second Class postage paid at:
Chelmsford, MA 01824 and Avon, MA
02322
USPS Publication Number: 483470
ISSN: 0271-9002

Send subscriptions, change of address, USPS Form 3579, requests for back issues and all other fulfillment questions to

MICRO
P.O. Box 6502
Chelmsford, MA 01824
or call
617/256-5515

Subscription rates	Per Year
U.S.	\$18.00
Foreign surface mail	\$21.00
Air mail:	
Europe	\$36.00
Mexico, Central America	\$39.00
Middle East, North Africa	\$42.00
South America, Central Africa	\$51.00
South Africa, Far East, Australasia	\$60.00

Copyright © 1981 by MICRO INK, Inc.
All Rights Reserved

MICRO

Editorial

This issue marks an unusual and important occasion for MICRO. After thirty-eight consecutive editorials, the first of which appeared back in 1977, Editor/Publisher Bob Tripp has finally decided to take a break. Thus, the task of writing this month's editorial has been passed to the editorial staff, and has landed on me! My name is Ford Cavallari, the Apple specialist at MICRO and the editor of the series *MICRO on the Apple*. Starting this month, I assume additional responsibilities for the magazine as an associate editor. Let me take this opportunity to share with you some thoughts that I, along with the rest of the staff, have been having about the magazine's course.

This month, the first non-system oriented bonus section makes its appearance in our magazine. In June, as you may recall, we enlarged MICRO, in part to extend our coverage of the Apple, and in part to expand our coverage of other systems and other areas. The two bonus sections which now appear in each issue afford us quite a bit of editorial flexibility, and this flexibility is reflected in this month's special printer bonus. With this new format, we have tackled an in-depth special on printers without sacrificing other areas of the magazine's coverage. In fact, we did it with ease, and still provided additional Apple coverage!

In the coming months, we will be presenting more widely varied bonuses, ranging from more system-oriented coverage of the PET, the OSI, the Apple, and the single boards, to some more concept-oriented features on topics like games, computer languages, and the 6809.

I am particularly excited about the coming games bonus section which will be appearing in November. While MICRO has historically leaned more toward the serious computer user than toward the gamer (see September 1980 Editorial, 28:5), we do realize, and concede, that there are few microcomputer demonstrations quite as graphic or fun as a good game. Also, there are very few ways to get children interested in

computers, aside from games. Our games bonus section will feature games articles, games programs, and games advertising, just in time for the gift-giving season. If you have original material which you feel would be appropriate for this section, please send it in, and we will consider it. We plan each issue months in advance, so send us your original games and articles quickly.

Another coming feature is our Pascal bonus section, scheduled for January. Pascal is now available on many microprocessors, and will soon become available on more. It is evident, in both the micro and mainframe communities, that Pascal is going to be very important in the future. The Pascal bonus section should be of interest to the novice and expert alike, for it will include both introductory tutorial material and programs demonstrating advanced techniques. Other languages to be featured in future bonuses are FORTH, BASIC, and assembly language.

OSI readers will notice the omission this month of the *Small Systems Journal*. The Journal has not moved to another publication. Rather, it has been suspended indefinitely by Ohio Scientific. We regret this, because we believe the Journal provided OSI users with a valuable service in a format unique to the microcomputer industry. If you feel strongly about the Journal, why not let OSI hear directly from you in writing! In the mean time, keep the OSI articles coming in and keep reading MICRO as we schedule more OSI bonuses.

One last word on the Reader Survey Form appearing in last month's MICRO. When Bob Tripp started MICRO back in 1977, it was partially due to the fact that he felt the 6502 community to be a more cohesive, enthusiastic group than, say, the 8080 community. The tremendous response that we've gotten so far from the Reader Survey indicates that your group enthusiasm has not waned. If you haven't sent in your form, and if you wish to have a direct influence on the magazine, here is your chance. In order for us to schedule features and bonuses, we have to have some idea of who is going to read them. Thanks for the response so far. Let's make it 100 per cent.

OSI

AARDVARK NOW MEANS BUSINESS!

OSI

WORD PROCESSING THE EASY WAY— WITH MAXI-PROS

This is a line-oriented word processor designed for the office that doesn't want to send every new girl out for training in how to type a letter.

It has automatic right and left margin justification and lets you vary the width and margins during printing. It has automatic pagination and automatic page numbering. It will print any text single, double or triple spaced and has text centering commands. It will make any number of multiple copies or chain files together to print an entire disk of data at one time.

MAXI-PROS has both global and line edit capability and the polled keyboard versions contain a corrected keyboard routine that make the OSI keyboard decode as a standard typewriter keyboard.

MAXI-PROS also has sophisticated file capabilities. It can access a file for names and addresses, stop for inputs, and print form letters. It has file merging capabilities so that it can store and combine paragraphs and pages in any order.

Best of all, it is in BASIC (OS65D 51/4" or 8" disk) so that it can be easily adapted to any printer or printing job and so that it can be sold for a measly price.

MAXI-PROS — \$39.95

THE EDSON PACK ALL MACHINE CODE GAMES FOR THE 8K C1P

INTERCEPTOR — You man a fast interceptor protecting your cities from Hordes of Yucky Invaders. A pair of automatic cannons help out, but the action speeds up with each incoming wave. It's action, action everywhere. Lots of excitement! \$14.95

MONSTER MAZE — An Arcade style action game where you run a maze devouring monsters as you go. If one sees you first, you become lunch meat. Easy enough for the kids to learn, and challenging enough to keep daddy happy. \$12.95

COLLIDE — Fast-paced lane-switching excitement as you pick up points avoiding the jam car. If you succeed, we'll add more cars. The assembler code provides fast graphics and smooth action. \$9.95

**SPECIAL DEAL—THE ENTIRE EDSON PACK—
ALL THREE GAMES FOR \$29.95**

THE AARDVARK JOURNAL

FOR OSI USERS — This is a bi-monthly tutorial journal running only articles about OSI systems. Every issue contains programs customized for OSI, tutorials on how to use and modify the system, and reviews of OSI related products. In the last two years we have run articles like these!

- 1) A tutorial on Machine Code for BASIC programmers.
- 2) Complete listings of two word processors for BASIC IN ROM machines.
- 3) Moving the Directory off track 12.
- 4) Listings for 20 game programs for the OSI.
- 5) How to write high speed BASIC — and lots more —

Vol. 1 (1980) 6 back issues - \$9.00

Vol. 2 (1981) 2 back issues and subscription for 4 additional issues - \$9.00.

ACCOUNTS RECEIVABLE — This program will handle up to 420 open accounts. It will age accounts, print invoices (including payment reminders) and give account totals. It can add automatic interest charges and warnings on late accounts, and can automatically provide and calculate volume discounts.

24K and OS65D required, dual disks recommended. Specify system.
Accounts Receivable. \$99.95

*** SPECIAL DEAL — NO LESS! ***

A complete business package for OSI small systems — (C1, C2, C4 or C8). Includes MAXI-PROS, GENERAL LEDGER, INVENTORY, PAYROLL AND ACCOUNTS RECEIVABLE — ALL THE PROGRAMS THE SMALL BUSINESS MAN NEEDS. \$299.95

P.S. We're so confident of the quality of these programs that the documentation contains the programmer's home phone number!

SUPERDISK II

This disk contains a new BEXEC* that boots up with a numbered directory and which allows creation, deletion and renaming of files without calling other programs. It also contains a slight modification to BASIC to allow 14 character file names.

The disk contains a disk manager that contains a disk packer, a hex/dec calculator and several other utilities.

It also has a full screen editor (in machine code on C2P/C4) that makes corrections a snap. We'll also toss in renumbering and program search programs — and sell the whole thing for — SUPERDISK II \$29.95 (5 1/4") \$34.95 (8").

BOOKKEEPING THE EASY WAY — WITH BUSINESS I

Our business package 1 is a set of programs designed for the small businessman who does not have and does not need a full time accountant on his payroll.

This package is built around a **GENERAL LEDGER** program which records all transactions and which provides monthly, quarterly, annual, and year-to-date **PROFIT AND LOSS** statements. **GENERAL LEDGER** also provides for cash account balancing, provides a **BALANCE SHEET** and has modules for **DEPRECIATION** and **LOAN ACCOUNT** computation.
GENERAL LEDGER (and MODULES) \$129.95.

PAYROLL is designed to interface with the **GENERAL LEDGER**. It will handle annual records on 30 employees with as many as 6 deductions per employee.
PAYROLL - \$49.95.

INVENTORY is also designed to interface with the general ledger. This one will provide instant information on suppliers, initial cost and current value of your inventory. It also keeps track of the order points and date of last shipment.
INVENTORY - \$59.95.

GAMES FOR ALL SYSTEMS

GALAXIAN - 4K - One of the fastest and finest arcade games ever written for the OSI, this one features rows of hard-hitting evasive dogfighting aliens thirsty for your blood. For those who loved (and tired of) Alien Invaders. Specify system — A bargain at \$9.95

MINOS - 8K — Features amazing 3D graphics. You see a maze from the top, the screen blanks, and when it clears, you are in the maze at ground level finding your way through on foot. Realistic enough to cause claustrophobia. — \$12.95

NEW — NEW — NEW

LABYRINTH - 8K - This has a display background similar to MINOS as the action takes place in a realistic maze seen from ground level. This is, however, a real time monster hunt as you track down and shoot mobile monsters on foot. Checking out and testing this one was the most fun I've had in years! — \$13.95.

TIME TREK - 8K - Real Time and Real graphics Trek. See your torpedoes hit and watch your instruments work in real time. No more unrealistic scrolling displays! — \$9.95

SUPPORT ROMS FOR BASIC IN ROM MACHINES — C1S/C2S. This ROM adds line edit functions, software selectable scroll windows, bell support, choice of OSI or standard keyboard routines, two callable screen clears, and software support for 32-64 characters per line video. Has one character command to switch model 2 C1P from 24 to 48 character line. When installed in C2 or C4 (C2S) requires installation of additional chip. C1P requires only a jumper change. — \$39.95
C1E/C2E similar to above but with extended machine code monitor. — \$59.95

AND FUN, TOO!

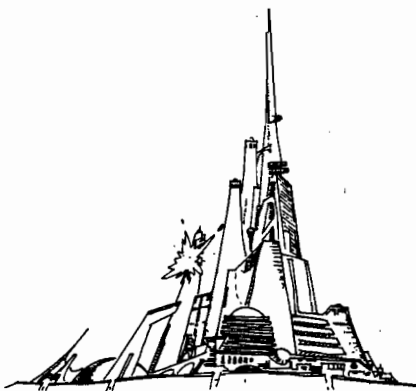

Please specify system on all orders

This is only a partial listing of what we have to offer. We now offer over 100 programs, data sheets, ROMS, and boards for OSI systems. Our \$1.00 catalog lists it all and contains free program listings and programming hints to boot.

AARDVARK TECHNICAL SERVICES, LTD.
2352 S. Commerce, Walled Lake, MI 48088
(313) 669-3110



OSI



OSI

MICROCRUNCH: An Ultra-fast Arithmetic Computing System

Part 1

Extremely fast floating point processing can be attained by coupling an INTEL 8231 arithmetic processing unit to the OSI Superboard II and using a partial compiler to generate machine code representations of mathematical equations and loops written in BASIC.

John E. Hart
Dept. of Astrogeophysics
University of Colorado
Boulder, Colorado 80309

An editorial in *BYTE* magazine (*BYTE*, vol. 5, number 10, Oct. 1980) quoted a survey that indicated that 40% of the readers of that microcomputer magazine were scientists or engineers. Obviously a very large number of small system users got into microcomputing because they hoped to use their machines for mathematical problems occurring in these fields. Although many applications of 6502 processors have been in tasks that do not require sophisticated mathematical manipulation (like graphics, games, word processing, etc.) there is certainly a host of interesting and/or practical problems that can be approached via numerical analysis on a microcomputer. These problems span the entire spectrum of mathematical modeling, from ecosystems to weather systems, from circuit analysis to support calculations in data analysis.

Such applications are only limited by the product of the floating point throughput (or speed) of the microprocessor and associated software, and the patience of the operator to wait around for the answer. It is often most profitable and convenient to approach mathematical problems in an interactive mode, where, for example, a problem depending on a certain parameter is iterated to an end point. The result is then inspected by the operator,

the parameter varied, and the solution repeated, until the desired answer is obtained. Such a scheme would be fruitful if the iteration time is fairly short. If you have to wait half an hour between answers it can be very frustrating. The iteration time is, of course, proportional to the length of the mathematical problem, in terms of the total number of floating point operations per iteration, divided by the effective computing speed of the machine being used. Unfortunately when it comes to floating point number crunching, microcomputers can be annoyingly slow. The purpose of this series of two articles is to describe a 6502-based system called MICROCRUNCH that is extremely fast at floating point mathematical number crunching.

The system consists of an OSI Superboard II with the 610 board memory expansion, interfaced to an INTEL 8231 math chip, which will be discussed later, in detail. This article describes the hardware necessary to accomplish this interface.

True number crunching speed is only possible if such a math chip is treated as a co-processor in the sense that floating point operations executed by the 8231 are done asynchronously as the 6502 is preparing for the next operation. Thus a special BASIC compiler that converts higher order statements into optimal 6502 machine code is a must if the potential for fast execution inherent in the 8231 is to be realized. Part 2 of this series will describe the software necessary to do this. We start by indicating what kind of speeds can be attained with the MICROCRUNCH system.

Computing speed for mathematical applications is usually measured in terms of megaflops (Mflops); or millions of floating point operations (+, -, *, /) that a computer, plus associated support software can execute per second. Obviously no one expects a micro to compete with a 32-bit mainframe designed

specifically to do scientific computing, but it is interesting to compare a few typical systems in this regard and to note how well a little 8-bit micro can perform. Computing speed can be crudely estimated by running the following simple benchmark program on several machines.

```
A = 1.00013
X = 1
FOR I = 1 TO 40000
X = X * A
NEXT I
PRINT X
STOP
```

From this, one gets a pretty good idea of the Mflop capability of a machine, since usually, the overhead for the FOR loop part of this little program is small compared to the time it takes to look up the variables X and A, and to perform the multiplication. I have tried this little loop on a variety of computers, some of which used a FORTRAN version. The results are shown in table 1.

There are several conclusions that can be made from this table, such as:

1. Traditional 6502 or Z-80 machines with BASIC interpreters are quite slow, doing about 100 to 200 flops per second. A calculation with 10,000 flops would take a couple of minutes, which is too slow for comfortable interactive computing.
2. The use of a compiler (Pascal or FORTRAN) on the straight 6502 machines only helps by a factor of 2 or so in speed. Although for a compiler the variable fetch and line decode times go way down, the time for actual addition, division, etc., in floating point stays the same.
3. Increasing the computer clock helps in direct proportion to the clock increase. At most, this might gain a factor of 4 if the typical 6502 micro can be made to run at 4 MHz.

4. Floating point chips without compilers are almost useless.
5. The optimal 8-bit system described here outperforms many standard minicomputers, at a fraction of their cost.
6. If you want personal number crunching in excess of around .01 Mflops (10^4 floating point operations per second), be prepared to spend a large amount of money.

Assuming the reader is interested in attaining floating point throughput in excess of 50 times the typical micro performance, we proceed to outline the MICROCRUNCH hardware, including circuits, a layout, and a parts list.

The Hardware

The physical system is shown in figure 1. The basic computer is the OSI Superboard II. It has been connected to a fully populated OSI 610 memory board. Thus the starting element is essentially a 6502 computer with 32K of RAM. The 610 board has an expansion plug that contains buffered data, address, phase two, read/write, and interrupt lines. This is connected to the arithmetic processor board (APB) whose circuit is given below. This APB board could be connected to any 6502 system that has available the same buffered lines as on the OSI 610. These are given in more detail in table 2.

Thus, in principal, the APB circuit can be used on a variety of machines (AIM, Apple, etc.) provided the address assigned to the arithmetic processor does not conflict with the memory map of the host computer. Because the compiler described in part 2 of this article uses up 20K of memory, and the upper 12K of this system is needed for source and object code storage, there is not much room left for a disk operating system. So, I use magnetic tape as a bulk storage medium. This would not be necessary if a machine with 48K of RAM were employed. However, the tape storage system I use is almost as fast as disk, so there is little performance loss here (see "An Ultra-Fast Tape Storage System," J.E. Hart, MICRO, November 1980, 30:11).

In addition I have jumped the fundamental clock on my Superboard up to 2 MHz as described by J.R. Swindell ("The Great Superboard Speedup," MICRO, February 1980, 21:30). The timing for the MICROCRUNCH system in table 1 was with a 2 MHz clock. For 1 MHz, the Mflop rate is .007. The tape

Table 1: Approximate Megaflop Rates for Several Computing Systems

Computer	Language	Mflop (million flops/sec)
TRS80 model I (Z-80)	BASIC interpreter	.00012
TRS80 model II (Z-80)	" "	.00026
INTERCOLOR (Z-80)	" "	.00014
APPLE II (6502, 1 MHz)	" "	.00019
APPLE II	Pascal compiler	.00034
APPLE II w/AMD9511 floating point board (Calif. Digital)	APPLEFAST interp.	.00026
OSI Superboard II (1 MHz)	BASIC interpreter	.00022
OSI Superboard II (2 MHz)	" "	.00044
PDP1103 w/Hdw. floating point board (DEC)	FORTRAN	.004
*MICROCRUNCH (OSI 2 MHz + INTEL 8231)	BASIC compiler	.011
PDP 1134	FORTRAN	.04 approx.
VAX 11/750 (DEC)	"	.4 "
CDC 7600	"	4-6 "
CRAY I	"	60 "

Figure 1: MICROCRUNCH Hardware

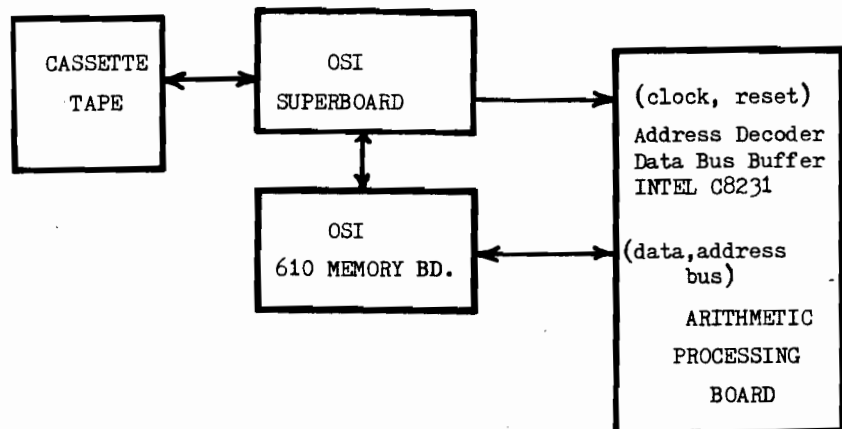

baud rate and clock modifications are not necessary for successful operation of the APB, but they are useful changes that increase performance and convenience.

The APB part of the system consists of an address decoder, a data bus buffer, a read/write/command/data decoder and the INTEL 8231 arithmetic processing unit. In order to understand the circuits that follow it is necessary to give a brief description of the 8231.

Anyone getting into this project should obtain the 8231 manual from a local INTEL representative, since only a brief sketch of the processor can be given here. When ordering this part, be

sure to get the C8231, since this will run at 4 MHz and the regular 8231 will not. The 8231 has the following features of interest:

1. An operand stack that stores 4 floating point numbers with $6\frac{1}{2}$ decimal digit precision and a range of about $10^{\pm 20}$. Each floating point number is represented by 4 bytes: 1 for the exponent and 3 for the mantissa. The floating point format will be discussed in part 2. It is, unfortunately, not the same as that used by Microsoft BASIC.

2. A 1-byte status register that can be read into the 6502. This status register contains a busy bit that in-

Table 2: Connector J2a on Arithmetic Board

Pin	Function
1	buffered address bus bit 0
2	" " " " 1
3	" " " " 2
4	" " " " 3
10	buffered data bus bit 0
	" " " " 1
11	" " " " 2
12	" " " " 3
13	
15	buffered read/write (read to 6502 if high)
18	data direction (enable read to 6502 if low)
19	buffered phase 2 clock
28	buffered data bus bit 4
	" " " " 5
29	" " " " 6
30	" " " " 7
31	
33	buffered address bus bit 8
	" " " " 9
34	" " " " 10
35	" " " " 11
36	" " " " 12
37	" " " " 13
38	" " " " 14
39	" " " " 15
40	" " " " "

Figure 2: Address Decoder Circuit

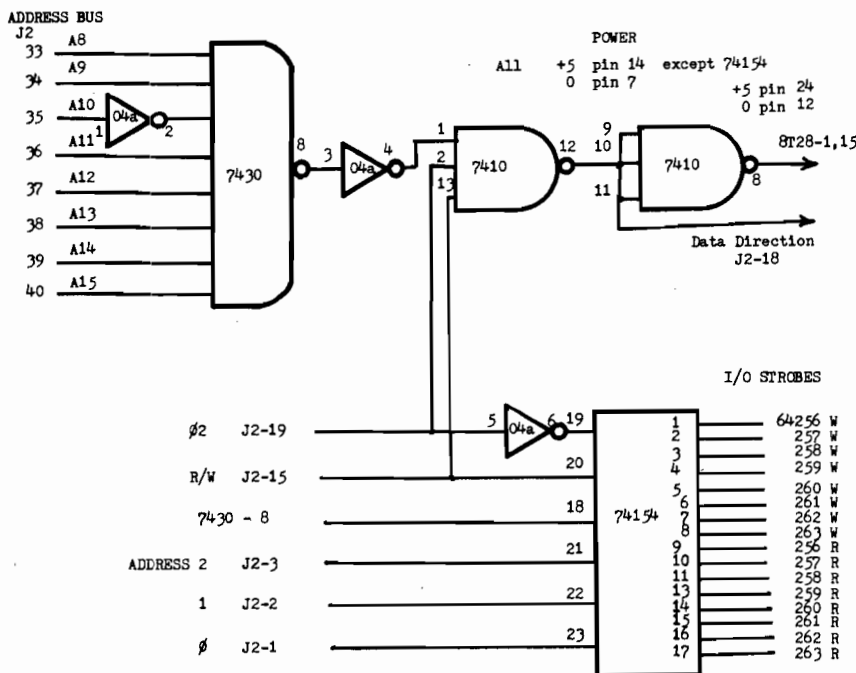

indicates whether a previously initiated floating point command is still in progress, and an error field that indicates if the previously completed command resulted in an error (overflow, underflow, divide by zero, improper function argument like square root of a negative number, etc.).

3. A 1-byte command register that is written into by the 6502. This initiates a floating point operation on the operand(s) that are stored on the stack in the 8231. These operations include +, -, *, / and a host of transcendental functions like SIN, COS, ARCTAN, etc. (See the manual for a complete description of these.) Suffice it to say that just about any problem you could have done with Microsoft BASIC you can do within the 8231, only much faster. The result of a calculation or operation appears on the top of the stack and can hence be read as a four-byte block transfer back into memory, under control of the 6502. These manipulations and some quirks of the floating stack are discussed in part 2, since they have more to do with software than hardware.

The scenario that emerges is as follows: A mathematical program written in BASIC is compiled by the 6502. There the object code, so generated, causes appropriate 4-byte transfers in and out of the APB, of floating point variables appearing in the mathematical expressions that were compiled. The 6502 also sends operation commands at the appropriate times and checks for errors after an operation is completed. Thus the main task of the hardware is to allow the 6502 to transfer data in and out of the 8231 stack, command, and status registers. Thus, we are really concerned with a fast I/O problem.

Readers of the 8231 manual will note that it also does fixed point arithmetic (16- or 32-bit). None of these functions are used in the MICROCRUNCH system, but software could be written to use these if needed.

Circuit Description

Described below is the circuit for the APB and its interconnections to the 610 board. The components for this board, all bought retail, cost about \$340, with \$270 going for the INTEL C8231. In addition, the 8231 uses 12V DC so a regulated supply of some sort (low current, 100 mA is fine) is needed. It should be mentioned here that the 8231 is identical in architecture and pin-outs to the older AMD 9511. The latter chips are a little cheaper (\$195), but are designed to

run at 2 MHz instead of 4 MHz. I went with the INTEL because the speed increase seemed worth the extra money.

The main interface with the 610 board is via its connector J2. This 40-pin connector is linked to a similar 40-pin IC socket-type connector on the APB with a ribbon cable. Table 2 shows the lines available on J2 that are used on the APB.

In addition to this interface, an additional connector J3 must be used to supply the following signals from the Superboard itself. In my unit this is a 14-pin IC socket connected by a ribbon cable to a similar socket set in one of the prototype holes in the Superboard.

J3-1	4 MHz clock (SBD II, U30-2)
J3-2	Ground
J3-3	BRK line (low = reset) (SBD U8-40)

The APB circuit will work with any 6502 computer that supplies the I/O connections as described above.

Figure 2 shows the address decoder circuit. Address lines 8 through 15 are fed into an 8 input nand gate, and line 10 is inverted. The output of this gate will go low whenever the address high byte goes to \$FB. This is the basic block address for the APB. The output of this gate is fed to one enable input of a 74154 4-to-16-line demultiplexer, and to a set of inverters and gates whose purpose is to generate a data direction pulse in phase with the 02 clock pulse. The outputs of the 74154 are a set of strobes that go low in phase with 02 whenever address FB is selected. Only one strobe is fired, depending, as well, on the R/W, A0, A1, and A2 lines. These strobes can be used to select various I/O devices, 16 in all. For the APB we shall use only 5 of these lines, so the others can be used for future expansion (A-D, D-A, etc.). The data direction pulse does two things. It informs the data buffers on the 610 board when data is going to be fed back to the 6502 (J2-18, low = read) and after inversion, chip 7410-8 does the same for the data buffers just ahead of the 8231.

Figure 3 shows the interconnections for the two on-board 8T28 tri-state buffers needed to drive the cable connecting the APB to the 610 board.

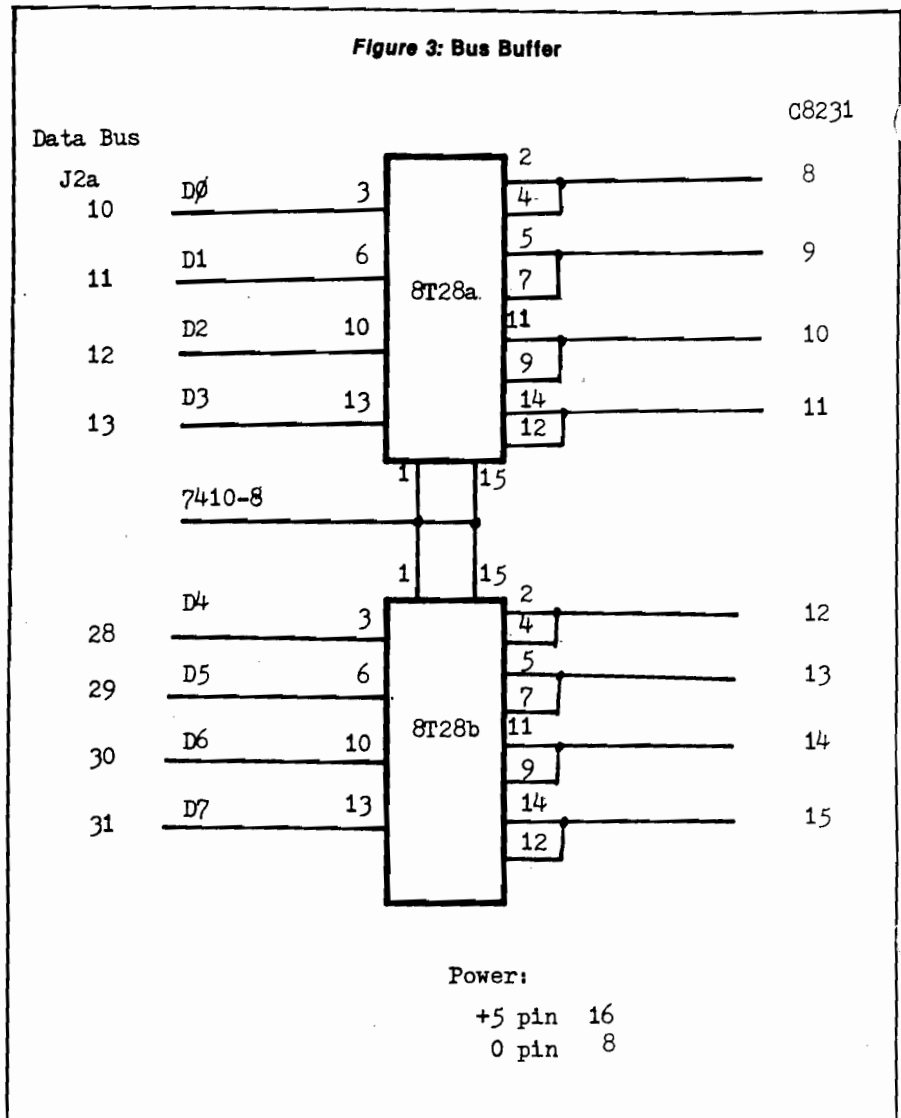

Finally, figure 4 shows the interconnections between the strobe lines from the address decoder and the 8231. During a write operation pin 1 of the 7402 NOR gate will go low. This signal is inverted and fed through another part of the 7402 quad NOR gate to give a low CHIP-SELECT pulse. The 8231 timing requirements indicate that the active low WRITE pulse must be shorter than the CHIP-SELECT input so the WRITE strobe is shortened by feeding into a 74123 one-shot. If an operand is being written onto the 8231 floating stack, pin 21 must go low. This is accomplished by sending the inverted WRITE OPERAND strobe to 7402-8. The resulting inverted OR pulse then becomes the appropriate C/D line.

A read of either the operand stack or the status register is preceded by a READ INITIATION strobe. For example, a READ STATUS START strobe (e.g. LDA ABS FB00) sets flip-flop 74LS76A. The

output of this flip-flop goes high and causes the CHIP-SELECT line (APU-18) and the READ line (APU-20) both to go low. The 8231 then proceeds to send the status register contents to its internal data bus buffer. This takes several clock cycles (like an EPROM), so data is not entered into the 6502 accumulator until a READ ENTER strobe is fired. That is, flip-flop A stays set until an LDA-ABS FB06 instruction is executed. Then strobe line 74154-16 goes low terminating the read by resetting the flip-flop on its rising edge.

Typically, then, two consecutive LDA's are used to read from the 8231. Data is read by LDA-ABS FB01, LDA-ABS FB06. The only difference between this and a status read is that flip-flop B sets the C/D line low (via 7402-10) in addition to pulling the CHIP-SELECT and READ lines low. The double LDA read cycle required by this circuit is slightly (20%) less efficient in time than

using the 6502 ready line in a pause circuit. Unfortunately, in the Superboard this line is tied to ground. However, during long mathematical manipulations one is almost always writing data and commands into the APU, reading only at the end of a string of operations. Therefore, this lost time becomes insignificant.

The 4 MHz clock and the reset pulses are connected as indicated.

Table 3 gives the APB addresses and typical commands used to communicate with it. For machines other than OSI, these addresses may fall in already assigned areas of the memory map. If so, the base address FB can easily be

changed by altering the inputs to the 7430 address gate. For example, if the inverter on line 10 is not used, the high part of the APB address will be \$FF. If this is done, however, some straightforward address changes will need to be made in the software presented here and in part 2.

Figure 5 gives a typical layout for the APB. One first installs the wire-wrap sockets (assuming the board will be wire-wrapped, not soldered), and routes the power lines. Install .01 mfd bypass capacitors on each chip between the +5 volt line and ground. After wrapping the preceding circuits, the board should be tested using some simple programs presented below. The basic questions are, can you get operands in and out of the unit, and can you command it to execute operations?

Table 3: Arithmetic Board Addresses and Machine Code Access Statements

Address	Function	Machine Code
64256 FB00	APU READ STATUS start	LDA-ABS FB00
64257 FB01	APU OPERAND READ start	LDA-ABS FB01
64262 FB06	APU WRITE OPERAND	STA-ABS FB06
64262 FB06	APU READ DATA (status or operand, as determined by previous start pulse)	LDA-ABS FB06
64263 FB07	APU WRITE command to initiate operation	STA-ABS FB07

Testing

The first program listed in the appendix asks for an operation code. Among some useful ones for testing are: 26=push constant pi onto top of operand stack, 16=floating add, 17=floating subtract, 18=floating multiply, 19=floating division, 2=SIN, 3=COS, 25=exchange top operand with next lower operand. At the first request for an operation code, enter 26. The program then reads the stack, and assuming all is well, the top four bytes should represent the constant pi in the APU format. The arithmetic processor representations of several useful numbers are (most significant byte first):

```

pi =      2,201,15,218
1.0 =     1,128,0,0
-1.0 =    129,128,0,0
2.0 =     2,128,0,0
0 =       0,0,0,0
  
```

Thus the sequence of operations 26,26,3,25,3,17 should result in a zero on the top of the stack. Or 26,26,3,25,3,18 should result in a 1 there. The status register is also read and displayed.

The second program, when run, asks for a number between zero and 255. It writes this onto the top byte of the 8231 stack and then reads it. If what went in equals what comes back, the program asks for another number, otherwise an error message is printed out. With these two programs enough simple testing can be done to insure that the circuit is working correctly. With this hurdle completed we will be ready to look at

Figure 4: Arithmetic Processing Unit Control

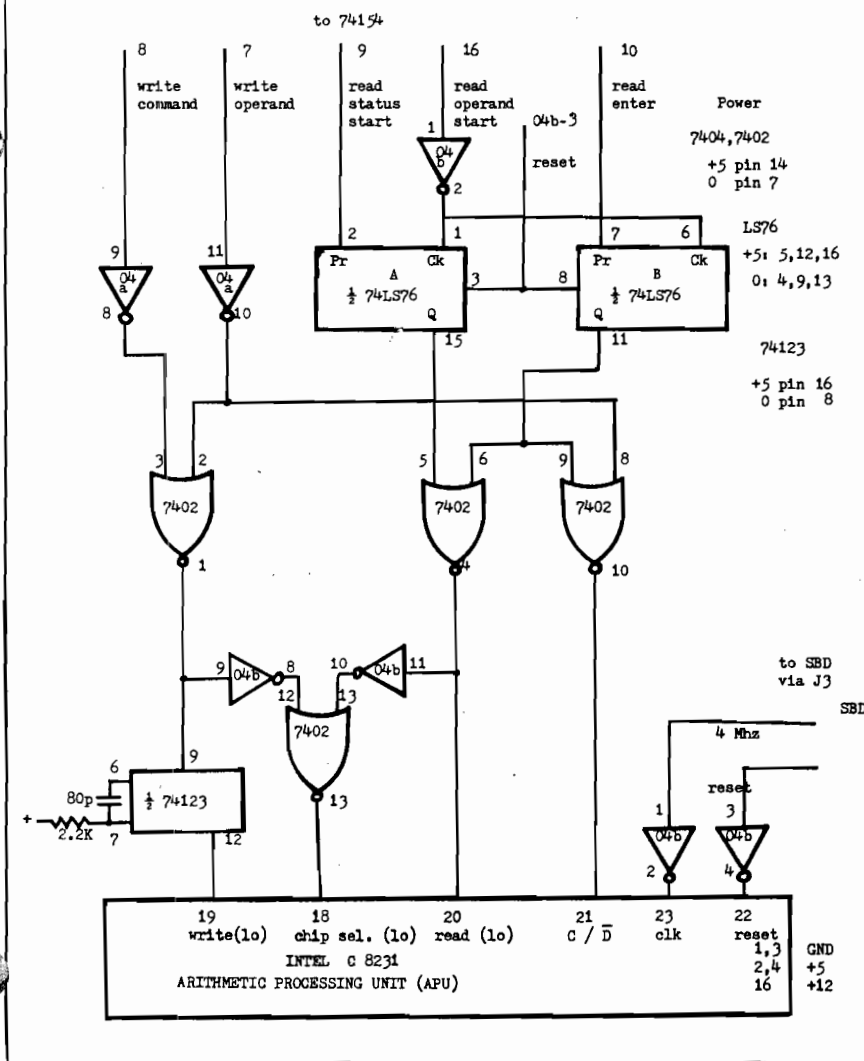

the software aspects of the system as described in part two of this article, which will be presented next month.

Appendix

Error codes, Parts list, BASIC test programs, and APU op codes.

INTEL 8231 Error Codes (decimal values of status register)

128 or greater	busy, operation not completed
64	top-of-stack negative, no error
32	top-of-stack zero, no error
16	divide by zero
8	negative argument of function not allowed (e.g. square root)
24	argument of function too big (e.g. Arc Sine, Arc Cosine, exponential)
4	underflow, number $< 2.7 \times 10^{-20}$
2	overflow, number $> 9.2 \times 10^{18}$
0	non-negative, non-zero result, no errors

Parts List

- 1 Vector board (at least 6" x 6")
- 1 40-pin wire-wrap socket
- 2 24-pin sockets
- 7 14-pin sockets (including 1 for connection to Superboard)
- 3 16-pin sockets
- 11 .01 disk capacitors (bypass)
- 1 80pf capacitor
- 1 2.2K resistor
- 2 7404 hex inverters
- 1 7402 quad NOR gate
- 1 7410 tri, three input NAND gate
- 1 7430 8 input NAND gate
- 1 74LS76 edge trigger flip-flop
- 1 74LS123 re-triggerable one shot
- 1 74154 4- to 16-line demultiplexer
- 2 8T28 tri-state buffers
- 1 INTEL8231 arithmetic processing unit
- Ribbon cable and connectors (40 and 14 wire)

MICRO

Figure 5: Layout — Wirewrap Side of Board

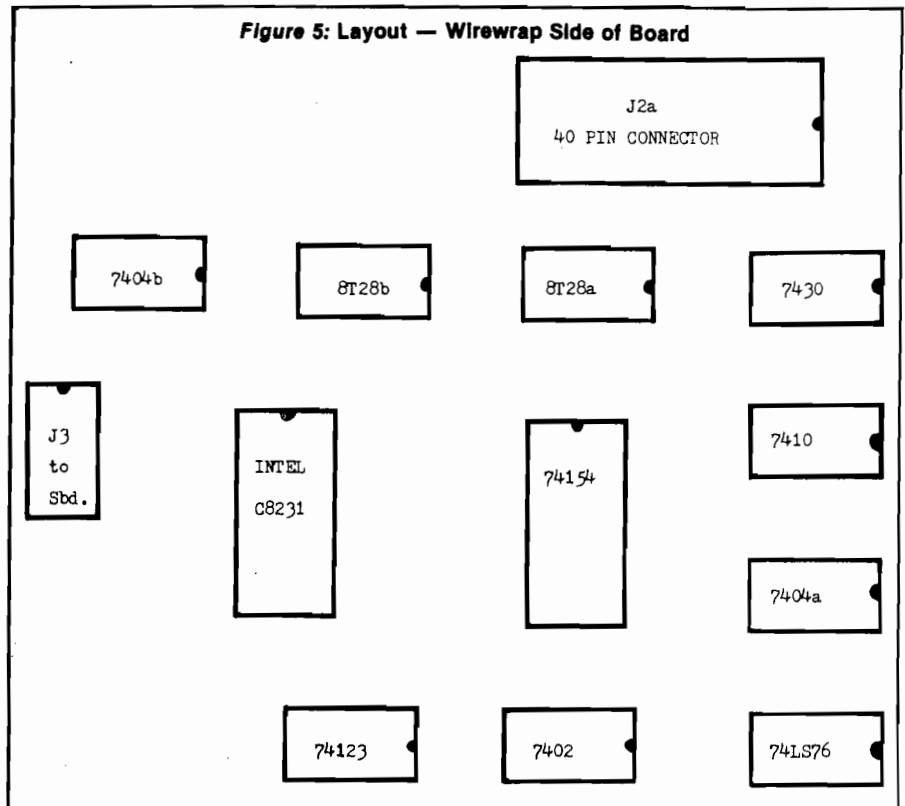

Listing 1

```

1  REM  APU TEST 1
2  REM  ENTER OPERATION COMMAND NUMBER
3  REM  STACK IS PRINTED FROM TOP DOWN.
   STACK HOLDS 4,4-BYTE FLT NMBRs.
9  INPUT "COMMAND";Y: POKE 64263,Y
10 A = 64257:B = 64262: PRINT : PRINT
11 PRINT "FOR COMMAND CODE=";Y
17 X = PEEK (A - 1): PRINT "STATUS=";
   PEEK (B)
20 FOR J = 1 TO 16:X = PEEK (A): PRIN
   T PEEK (B)
25 NEXT J
27 GOTO 9

```

Listing 2

```

1  REM  APU TEST 2
2  REM  ENTER INPUT BYTE BETWEEN ZERO A
   ND 255
3  REM  POKE TO APU, THEN READ. IF EQUA
   L, OK.
10 INPUT "X=";X
12 POKE 64262,X: REM  WRITE OPERAND ON
   TOP OF APU STACK
15 Y = PEEK (64257): REM  OPERAND READ
   START
16 Y = PEEK (64262): REM  READ DATA
20 IF Y < > X THEN PRINT "APU R/W ER
   ROR": PRINT "X=";X;"Y=";Y
22 IF Y = X THEN PRINT "R/W OK"
25 GOTO 10

```

GRAPHICS FOR OSI COMPUTERS

- ☆ You Can Produce The Images Shown Or Yours And Program Motion With Our 256 By 256 High Resolution Graphics Kit. Thats 65,536 Individually Controlled Points On Your TV Screen.
- ☆ Increase Column/Line Display. You Can Set Up Your Own Graphic Pixels Including Keyboard Characters And Unlimited Figures.
- ☆ This Kit Includes All Parts, Software And Assembly Instructions Required To Get Up And Running. The Included 8k Of 2114 Memory Is Automatically Available When Not Using The Graphics. Boot Up And See 8k More Memory.
- ☆ Adding The Kit Does Not Affect Your Existing OSI Graphics. Use Both At The Same Time Or Separately.
- ☆ Buy The Entire Kit, Including Memory, For \$185.00 Or A Partial Kit For Less If You Have Parts. Board And Instructions \$40.00. Instructions Include Software.

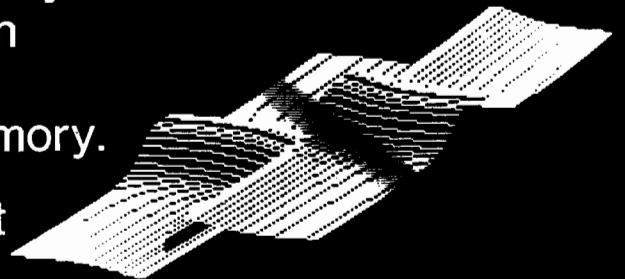
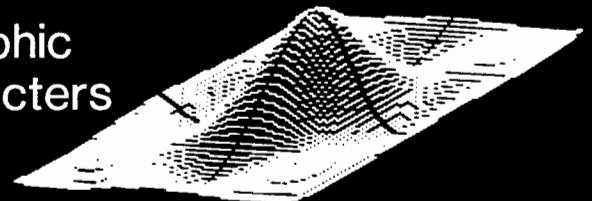
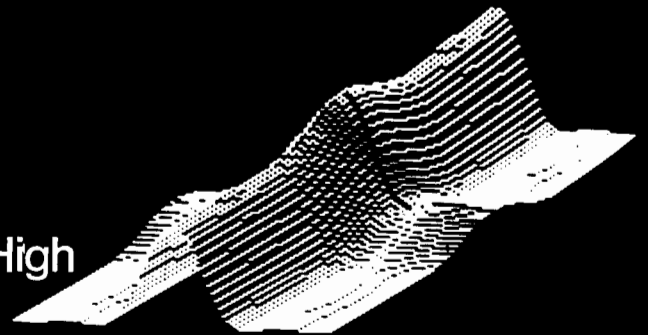

For This Kit Or A Catalog
Of Other Kits, Software
And Manuals Call Or Write:

MITTENDORF ENGINEERING
905 Villa Nueva Dr.
Litchfield Park, Az. 85340
(602)-935-9734

MICRO

PET Vet

By Loren Wright

HESLISTER

The most efficient way to enter a BASIC listing is shown in listing 1. Multiple statements on a line make execution faster, and the lack of spaces makes the program occupy considerably less memory. These listings are difficult to read, let alone understand. Do you remember which reverse field characters represent which cursor controls?

Listing 2 is the same set of lines as output by HESLISTER. Spaces have been inserted and multiple statements appear on separate lines. The cursor control characters appear as two-letter abbreviations within brackets. Also, IF...THEN and FOR...NEXT structures are indented appropriately. Since PET programs on cassette cannot be read as data, HESLISTER works only on disk. It is available for \$9.95 from:

Human Engineered Software
3748 Inglewood Blvd., Rm. 11
Los Angeles, California 90066

VIGIL from Abacus Software

Many of us have contemplated writing interactive games for the PET, but have never gotten beyond the contemplation stage. Moving large objects across the screen with BASIC can be very slow, and it takes time to write and debug the required machine language routines. If you want the use of paddles or sound, further complication is added.

VIGIL, an acronym for Video Interactive Game Interpretative Language, is a new "language" offered by Abacus Software. A few simplifications have been made. Instead of BASIC variables, there are 26 registers which can have a value from 0 to 255. Normal input is only from 16 keys on the numeric keypad. Also, only one statement is allowed per program line and no spaces may be embedded in commands. Anything appearing after a space is treated as a comment and ignored.

The commands, in general, are very powerful. There are four "Test and Skip" commands and three "Step and Test" commands, which transfer pro-

gram control depending on the value of a particular register. Control of PET's double resolution (or quarter-box) graphics is particularly easy. You can display a pattern at a specified x-, y-coordinate and erase it simply by repeating the display command. Whenever displaying a pattern overwrites another (as in a rocket hitting a plane!), the Z-register is affected. Messages and PET graphic characters are also displayed by specifying x-, y-coordinates.

Other features include sound (for a speaker hooked to CB2 of the parallel user port), timer control, key-testing, and variety of data movement and program control commands.

The VIGIL interpreter begins at \$033A (826) and runs to \$1300 (4864). Not much room is left for programs in an 8K machine, but there is still a lot that can be done. The tape (or disk) comes with nine sample programs: BREAKOUT, ANTI, SPACE WAR, SPACE BATTLE, U.F.O., CONCENTRATION, MAZE, KALEIDOSCOPE, and FORTUNE-TELLER. All these work with 8K, and they serve as good examples of different VIGIL programming techniques.

I also have a few complaints. Restricting input to the numeric keypad makes it awkward to play two-person games.

Sometimes the speed is a little disappointing — not up to pure machine language speed, but certainly faster than pure BASIC. Finally, some of the commands are difficult to remember. For example, THEN prints a character string at a specified location and Z and B are "increment and test" commands. It does take a little experience to get really comfortable with VIGIL, or any new language. The documentation is very good, and a separate reference list of commands is provided.

VIGIL, complete with user's manual and sample program, is available on disk or cassette (for BASIC 3.0 only) for \$35 from:

Abacus Software
P.O. Box 7211
Grand Rapids, Michigan 49510

October PET Bonus

The October MICRO will have a special PET bonus section — five or six articles. Features include "Growing Knowledge Trees" and "Character Set Substitution."

MICRO has Assemblers

MICRO has copies of HESBAL, MAE, and ASM/TED assemblers. We can accept articles with source files on disk or cassette in any of these formats.

Listing 1

```
165 IFT=ZTHENIFC$="," THENIFM$="" THENS=88:GOTO210
2140 FORK=ZTOW:IFG$=LEFT$(L$(K),D) THENL=K:T$=MID$(L$(K),D+3,U):K=W
2145 NEXT:RETURN
3000 PRINT"XXXXXXXXXX";
```

Listing 2

```
165 IF T=Z
  THEN IF C$=","
    THEN IF M$=""
      THEN S=88:
        GOTO 210
2140 FOR K=Z TO W:
  IF G$=LEFT$(L$(K),D)
  THEN L=K:
    T$=MID$(L$(K),D+3,U):
    K=W
2145 NEXT :
  RETURN
3000 PRINT "[CH][CD][CD][CD][CD][CD][CR][CR][CR]";
```

we carry it all...

Atari® Software

VisiCalc	149
CX4101 Invitation to Programming 1 ..	17
CX4104 Mailing List	17
CX4102 Kingdom	13
CX4103 Statistics	17
CX4105 Blackjack	13
CX4106 Invitation to Programming 2 ..	20
CX4107 Biorhythm	13
CX4108 Hangman	13
CX4109 Graph It	17
CX4111 Space Invader	17
CX4110 Touch Typing	20
CX4115 Mortgage & Loan Analysis	13
CX4116 Personal Fitness Program	13
CX4117 Invitation to Programming 3 ..	20
CX4118 Conversational French	45
CX4119 Conversational German	45
CX4120 Conversational Spanish	45
CX4121 Energy Czar	13
CX4125 Conversational Italian	45
CX8108 Stock Charting	20
CXL4001 Educational System Master ..	21
CXL4002 Basic Computing Language ..	46
CXL4003 Assembler Editor	46
CXL4004 Basketball	30
CXL4005 Video Easel	30
CXL4006 Super Breakout	30
CXL4007 Music Composer	45
CXL4009 Chess	30
CXL4010 3-D Tic-Tac-Toe	30
CXL4011 Star Raiders	33
CXL4015 TeleLink	20
Talk & Teach Courseware:	
CX6001 to CX6017	23

everything for Commodore and Atari

Atari® Peripherals:

400 16K	\$349
410 Recorder	59
810 Disk	469
815 Disk	1199
822 Printer	359
825 Printer	629
830 Modem	159
850 Interface Module	139

Atari® Accessories

CX853 16K RAM	89
CX70 Light Pen	64
CX30 Paddle	18
CX40 Joystick	18
CX86 Printer Cable	42
CO16345 822 Thermal Printer Paper	5
CAO16087 825 80-col. Printer Ribbon (3/box)	17
Microtek 16K RAM	79
Microtek 32K RAM	179

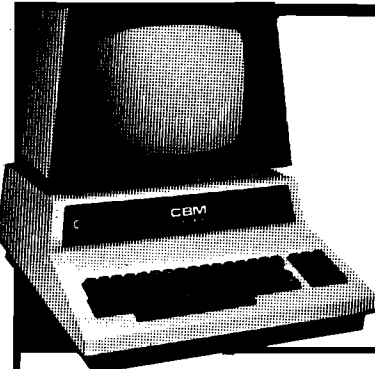

commodore

VIC-20	\$ 279
4032N	1020
8032	1175
CBM 4022 Printer	630
CBM 4040 Drive	1020
CBM 8050 Drive	1420
CBM C2N Drive	87
PET-IEEE Cable	37
IEEE-IEEE Cable	46

Disks

Maxell Disks	10 for \$36
Syncom Disks	10 for 29
Atari Disks	5 for 22

Software

EBS Accounts Receivable Inventory System	\$595
OZZ Information System	329
BPI General Ledger	329
Tax Package	399
Dow Jones Portfolio Management ..	129
Pascal	239
WordPro 3 (40 col.)	186
WordPro 4 (80 col.)	279
WordPro 4 Plus (80 col.)	339
Wordcraft 80	319



ATARI 800™
with 32K RAM



only \$759

Printers

NEC 5530	\$2495
Diablo 630	2195
Trendcom 100	299
Starwriter	1495
Trendcom 200	489

Paper Tiger 445G	769
Paper Tiger 460G	1219
Epson MX-80	} Call for new prices!
MX-80FT	
MX-70	
Tally 8024	1699

No Risk -

**No Deposit On
Phone Orders -**

COD or

Credit Card - Shipped Same Day You Call*

Prepaid Orders Receive Free Shipping

* on all in stock units

Please Call Between 11AM & 6PM
(Eastern Standard Time)

(800) 233-8950



Computer Mail Order

501 E. Third St., Williamsport, PA 17701 (717) 323-7921

It's Time to Stop Dreaming

Part 3

Robert M. Tripp
Editor/Publisher
MICRO

Part 1 of this series (MICRO 37:9) introduced the Motorola 6809 as a candidate for the 6502 "Dream Machine" and discussed its basic architecture and fundamental characteristics. Part 2 (MICRO 38:27) presented the details on several major features of the 6809, particularly the support for writing position-independent code (PIC) and the extensive stack operations. Part 3 describes the instruction set in detail using terms familiar to MICRO readers, by comparing it instruction-by-instruction to our beloved 6502.

Table 1 presents the entire 6809 instruction set, with the exception of the Branches, which are presented in table 2. The table lists the instructions by both the 6502 and 6809. A brief study of the table will show how similar the instruction sets are. Most of the instructions available on the 6502 are also available on the 6809. The standard mnemonics are even identical for the most part. If a particular instruction is not available on one or the other processor, this has been indicated in the table by "----."

Notes and comments about the instruction set from the 6502 point of view:

1. The Carry Flag is not treated identically on the two processors. On the 6502, the Carry Flag is Cleared to indicate a "borrow" and Set to indicate "no borrow." (Remember the SEC before an SBC?) On the 6809, the Carry Flag is Set to indicate a "borrow" and Cleared to indicate "no borrow." While this "reversal" may cause a little difficulty at first, it does make sense if you think about it. You can start all arithmetic operations with a Clear Carry (CLC) instruction.
2. The programmed setting and clearing of the Condition Codes or Flags is handled quite differently on the 6809, but can be treated as almost identical forms. The 6502 has separate instructions for each Clear and Set. The 6809 uses a single instruction for Clearing any number of Flags and another single instruction for Setting any number of Flags. Flags may be Cleared by the ANDCC instruction which is two bytes: the opcode, and the mask which determines which Flags will not be cleared. Flags may be Set by the ORCC instruction which is also two bytes: the opcode, and the mask which determines which Flags will be set.
3. The ASL and LSL instructions are actually one and the same on the 6809. The 6809 has simply provided two sets of mnemonics. The ASR and LSR, however, are *not* equivalent. The ASR shifts the most significant bit back into the most significant position, thereby extending the sign for the original byte. The LSR shifts a zero into the most significant bit.
4. The EXG and TFR instructions may be used between any two registers of the same size, (that is, between any two 8-bit registers or any 16-bit registers), but may not be used between an 8-bit and a 16-bit. Therefore, the following instructions which would be valid on the 6502 would not be valid on the 6809:

TAX, TXA, TAY and TYA
5. The Push/Pull Stack operations on the 6502 require only one byte each. The Push/Pull Stack operations on the 6809 require two bytes, but can accomplish a lot more. On a single PSH, up to eight registers may be pushed. Which registers are to be pushed is specified in the second byte of the instruction. There is a fixed order in which registers are pushed onto the stack, and all of the registers may be pushed onto the stack, not just the A reg and Condition Codes as on the 6502. Similarly, a single PUL can pull one to eight registers. The order is: CC (Condition Codes) A B-DP (Direct Page) X Y U or S PC.
6. There are two independent Stacks on the 6809. The "S" Stack is similar to the 6502 stack, except that it has a 16-bit pointer and can be anywhere in memory. The "U" (User) Stack has all of the same operations as the "S" Stack, but is *not* used for hardware interrupt and subroutine processing.

An SEI on the 6502 would be equivalent to ORCC # $\$10$ on the 6809; a CLI would be ANDCC # $\$EF$. Since the 6809 has a set of individual instructions for each Flag just like the 6502, many 6809 assemblers will accept the 6800/6502 form and assemble it for the 6809. For example, many 6809 assemblers will accept SEI as a mnemonic and generate the object code for an ORCC # $\$10$.

Table 1: 6502/6809 Instruction Comparison Table

6502	6809			Notes and Details
---	ABX			Add B Reg to X Reg
ADC	ADCA	ADCB		Add with Carry Bit
---	ADDA	ADDB	ADDD	Add without Carry Bit
AND	ANDA	ANDB		Logical AND
ASL ASLA	ASLA	ASLB	ASL	Arithmetic Shift Left
---	ASRA	ASRB	ASR	Arithmetic Shift Right
BRK	SWI	SWI2	SWI3	6809 has three Software Interrupts
BIT	BITA	BITB		Binary Bit Test
---	CLRA	CLRB	CLR	Clear: Set to Zero
CLC, CLI, CLV	ANDCC			Clear Condition Codes by ANDing
CMP	CMPA	CMPB	CMPD	Compare Reg to Memory
CPX	CMPX			Compare Index Reg to Memory
CPY	CMPY			Compare Index Reg to Memory
---	CMPS	CMPU		Compare Stack Reg to Memory
---	COMA	COMB	COM	One's Complement
---	DAA			Decimal Adjust replaces Decimal Mode
DEC	DECA	DECB	DEC	Decrement
DEX				(Part of Auto Decrement Index Mode)
DEY				(Part of Auto Decrement Index Mode)
EOR	EORA	EORB		Logical Exclusive OR
---	EXG	R1,R2		Exchange Specified Reg Contents
INC	INCA	INCB	INC	Increment
INX				(Part of Auto Increment Index Mode)
INY				(Part of Auto Increment Index Mode)
JMP	JMP			Jump to Address
JSR	JSR			Jump to Subroutine
LDA	LDA	LDB	LDD	Load Reg
LDX	LDX			Load Index Reg
LDY	LDY			Load Index Reg
---	LDS	LDU		Load Stack Reg
---	LEAX	LEAY	LEAS	Load Effective Address into Index Reg
---	LSLA	LSLB	LSL	Logical Shift Left
LSR LSRA	LSRA	LSRB	LSR	Logical Shift Right
---	MUL			Unsigned multiply: A*B=D
---	NEGA	NEGB	NEG	Two's Complement
NOP	NOP			No Operation
ORA	ORA	ORB		Logical OR
PHA,PHP	PSHS	PSHU		Push Specified Regs on Specified Stack
PLA,PLP	PULS	PULU		Pull Specified Regs from Specified Stack
ROL ROLA	ROLA	ROLB	ROL	Rotate Left
ROR RORA	RORA	RORB	ROR	Rotate Right
RTI	RTI			Return from Interrupt
RTS	RTS			Return from Subroutine
SBC	SBCA	SBCB		Subtract with Borrow
SEC,SED,SEI	ORCC			Set Condition Codes
---	SEX			Sign Extend B Reg into A Reg
STA	STA	STB	STD	Store Reg into Memory
STX	STX			Store Index Reg into Memory
STY	STY			Store Index Reg into Memory
---	STS	STU		Store Stack Reg into Memory
---	SUBA	SUBB	SUBD	Subtract without Borrow
TAX, TAY, TYA, TXA	---			Replaced by Transfer Instruction TFR
TSX, TXS	---			Use LDS/LDU, STS/STU, EXG or TFR
---	TSTA	TSTB	TST	Set Sign and Zero Condition Codes
---	TFR	R1,R2		Transfer Reg R1 to Reg R2

This page may be copied without permission from MICRO.

Table 2: Branch Instruction Comparison Table

6502	6809	Branch Operation	
Simple Branches			
BCC	BCC LBCC	Branch on Carry Clear	
BCS	BCS LBCCS	Branch on Carry Set	
BEQ	BEQ LBECQ	Branch on Equal Zero	
BNE	BNE LBNE	Branch on Not Equal Zero	
BMI	BMI LBMI	Branch on Minus	
BPL	BPL LBPL	Branch on Plus	
BVC	BVC LBVC	Branch on Overflow Clear	
BVS	BVS LBVS	Branch on Overflow Set	
Signed Branches			
---	BGT LBGT	Branch if Greater	
---	BGE LBGE	Branch if Greater or Equal	
---	BLE LBLE	Branch if Less or Equal	
---	BLT LBLT	Branch if Less	
Unsigned Branches			
---	BHI LBHI	Branch if Higher	
---	BHS LBHS	Branch if Higher or Same	
---	BLS LBLS	Branch if Lower or Same	
---	BLO LBLO	Branch if Lower	
Other Branches			
---	BSR LBSR	Branch to Subroutine	
---	BRA LBRA	Branch Always	
---	BRN LBRN	Branch Never !!!	

Notes: The 6809 has two forms of each Branch. The "short form" is identical to that on the 6502, using a one-byte offset which permits it to branch only to locations within plus or minus 128 decimal bytes from the branch instruction. The "long form," preceded by an L in the table, uses a two-byte offset which permits it to branch directly to any location in a 64K memory.

- The Clear instruction is simply a quicker way to load a zero into the A or B registers or into a memory location.
- There are two complement instructions. COM performs a one's complement on the A or B register or memory. This simply complements each bit of the specified location. NEG performs a two's complement which is equivalent to a COM plus one. This makes the negative value of the original number.
- On the 6809 you can simply increment or decrement the A and B registers with the INC and DEC commands. The 6502 requires a CLC, ADCIM #01 for an INC on A or an SEC, SBCIM #01 for a DEC on A. There is no specific INC or DEC for the X or Y registers, but this is normally handled in the auto-increment or auto-decrement indexed instruction modes.
- The LEA (Load Effective Address) is a powerful addition to the 6809 which has no counterpart in the 6502. It is one of the features that really makes the 6809 a "dream machine," but it will take some getting used to.

CBM/PET? SEE SKYLES ... CBM/PET?

PET? SEE SKYLES ... CBM/PET? SEE

"Should we call it Command-O or Command-O-Pro?"

That's a problem because this popular ROM is called the Command-O-Pro in Europe. (Maybe Command-O smacks too much of the military.)

But whatever you call it, this 4K byte ROM will provide your CBM BASIC 4.0 (4016, 4032) and 8032 computers with 20 additional commands including 10 Toolkit program editing and debugging commands and 10 additional commands for screening, formatting and disc file manipulating. (And our manual writer dug up 39 additional commands in the course of doing a 78-page manual!)

The Command-O extends Commodore's 8032 advanced screen editing features to the ultimate. You can now SCROLL up and down, insert or delete entire lines, delete the characters to the left or right of the cursor, select TEXT or GRAPHICS modes or ring the 8032 bell. You can even redefine the window to adjust it by size and position on your screen. And you can define any key to equal a sequence of up to 90 key strokes.

The Command-O chip resides in hexadecimal address \$9000, the rightmost empty socket in 4016 and 4032 or the rearmost in 8032. If there is a space conflict, we do have Socket-2-ME available at a very special price.

Skyles guarantees your satisfaction: if you are not absolutely happy with your new Command-O, return it to us within ten days for an immediate, full refund.

- Command-O from Skyles Electric Works.....\$75.00
- Complete with Socket-2-Me..... 95.00
- Shipping and Handling.....(USA/Canada) \$2.50 (Europe/Asia) \$10.00
- California residents must add 6%/6½% sales tax, as required.



Skyles Electric Works
231E South Whisman Road
Mountain View, California 94041
(415) 965-1735

Visa/Mastercard orders: call tollfree (800) 227-9998 (except California). California orders: please call (415) 965-1735.

... CBM/PET? SEE SKYLES ... CBM/PET? SEE SKYLES

- The inclusion of three separate software interrupts, in place of the single BRK on the 6502 should not upset anyone. It should make error trapping, debugging, and other interrupt-driven operations, considerably simpler to write and use.
- The 6502 requires that a two-byte address be provided in the form low byte/high byte. The 6809 uses the more natural form of high byte/low byte. At the Assembler level this does not make any difference, but at the Object level it does. All two-byte addresses on the 6809, including indirect addressing via tables, interrupt vectors, and so forth are high/low. Compare:

8D 34 12 STA \$1234 on the 6502
B7 12 34 STA \$1234 on the 6809

The two-byte address on the 6502 in object form is 34 12; on the 6809 it is 12 34.

This list may make it seem that there are a great number of differences between the 6502 and the 6809. The significant differences are actually quite minor, and in many cases the differences are in the direction of improved operations on the 6809.



Color computer owners, 32K PLUS DISKS* \$298.⁰⁰

Yes, that's right - for as little as \$298.00 you can add 32K of dynamic RAM, and a disk interface, to your TRS-80 Color Computer! If you just want the extra memory it's only \$199.00, and you can add the disk interface later for \$99.00.

Just plug the *Color Computer Interface (CCI)*, from Exatron, into your expansion socket and "Hey Presto!" - an extra 32K of memory. No modifications are needed to your computer, so you don't void your Radio Shack warranty, and Exatron give both a 30 day money-back guarantee and full 1 year repair warranty on their interface.

The *CCI* also contains a 2K machine-language monitor, with which you can examine (and change) memory, set break-points, set memory to a constant and block-move memory.

So what about the *CCI Disk Card*? Well as we said it's only an extra \$99.00, but you'll probably want Exatron's *CCDOS* which is only \$29.95 - unless you want to write your own operating system. The *CCI Disk*

Card uses normal TRS-80 Model I type disk drives, and *CCDOS* will even load Model I TRSDOS disks into your color computer - so you can adapt existing TRS-80 BASIC programs.

As a further plus, with the optional *ROM Backup* adaptor, you can dump game cartridges to cassette or disk. Once the ROM cartridge is on cassette, or disk, you can reload, examine and modify the software. The *ROM Backup* adaptor is only \$19.95.

For more information, or to place an order, phone Exatron on their Hot Line 800-538 8559 (inside California 408-737 7111), or clip the coupon.



excellence in electronics

exatron

DEALER ENQUIRIES INVITED

Exatron,
181 Commercial Street,
Sunnyvale, CA 94086



- Please send a 32K Color Computer Interface for \$199.00
- Please send a CCI Disk Card for \$99.00
- Please include CCDOS and manual for \$29.95
- Also include a ROM Backup adaptor for \$19.95

Please add \$5.00 for shipping to all orders, and 6 percent sales tax in California.

Name

Address

City

State Zip

Charge my:

MasterCard Interbank Code

Visa Expiration Date

Card

Check enclosed for

Ship COD (\$2.00 extra)

Signature

Improved *n*th Precision

This article discusses code optimization for small systems, using Golla's add/subtract routines (MICRO 27:27) as an example.

Glenn R. Sogge
Fantasy Research & Development
P.O. Box 203
Evanston, Illinois 60204

This article began as a couple of short notes on ways to optimize the coding of machine language programs for the 6502. The article and program in the August, 1980 issue of MICRO (27:27) by Lawrence R. Golla presented two routines for multiple precision adding and subtracting. These routines were transparent as far as register contents were concerned and returned the correct information in the flags.

As I began the actual recoding of the routines to satisfy a couple of my pet optimizing prejudices, I discovered that the zero checking routine seemed overly complicated and slow. The resulting "optimized code" is a complete reworking of the status information code, with a few other goodies thrown in, that increase the execution speed and lower the memory requirements.

Relocation

The first step was to make the routines position-independent. Whenever I find a short, versatile routine, I try to adapt it for easy use in most situations without the time-consuming process of individual relocations. I believe that any short routine that can easily be coded with branch instructions (even if a two- or three-stage branch is required) is preferable to one that contains absolute jumps. The only exception to this is in code that is critically time-dependent; even then, alternate codings can often be used. I think it is preferable to recode a routine once and just load it

where and when it is needed rather than having to remember which routines need which bytes changed. As the use of computers spreads through the public, I think it is the responsibility of programmers to make the use of their codes as easy as possible for the neophytes. Hand relocation of short routines is quite easy for someone with a little bit of programming experience but it is still not a conceptually trivial task.

A collection of routines coded this way can make up a very useful library that can be customized without the "big system" overhead of relocatable assemblers and linking loaders. Only as many of the system utilities as are needed get loaded into the machine.

Sometimes, the best way to improve a routine is not through the peephole optimization of small bits of code but by using a different algorithm. This kind of large-scale optimization is what really pays off in the long run. In these routines, I checked for a zero result in a very straight-forward and fast manner. The code begins (after the math is done) at MOUT by saving the C and V flags and assuming the result is probably not zero and that it is not negative. The code then starts checking the result bytes from lowest to highest. As soon as a non-zero byte appears, it exits this check code and leaves the Z flag at 0 (i.e., it found something to prove its assumption). Only as many bytes are checked as are necessary to prove this assumption; this might range from 1 to 128 but it only checks all 128 (unlike Golla's routine) if it has to. If the result does turn out to be zero, only then does it go through the Z flag machinations.

A similar logic is used for the N flag. It is assumed to be positive and changed only if this assumption is not true. A peephole technique was used to save the C and V flags and clear the N and Z flags with one instruction — the AND # $\$7D$ just after MOUT followed by the saving of this status on the stack (actually IN the stack).

Playing with the Stack

A big advantage of a hardware stack is the "free" temporary storage it provides. In the 6502, this chunk of memory is hardware address dedicated and rarely gets used for anything else. With a proper understanding of how to access this area, another page of temporary scratchpad RAM is available to the user. This can be important in small systems with small memories or in big systems whose software grabs all the page zero locations it can find.

Another advantage of accessing the stack memory is that the addresses need not be hard-coded in the software. It is possible to write everything relative to the current stack pointer and the hardware will do the translation into the proper bits on the address bus. This creates a very small virtually-mapped memory. Location $\$4$ relative to the stack pointer might be a different physical address every time the instruction is executed but the logical space is always the same.

In my recoding of the math routines, I used this technique for only one of the locations — the flags to be passed back to the calling routine. This ensures that that data will not be accidentally clobbered by the stack as might happen with Golla's use of locations $\$100$ and $\$101$; it also avoids the problems of selecting another address (page zero or elsewhere) that would conflict with locations used by other systems' hardware and software.

There is, unfortunately, no way to locate the pointers in equally flexible locations; if these locations conflict with others in the user's system, the code will have to be changed. Unlike the more advanced chip designs that make all kinds of relocation easy (data and programs), such as the 6809, we have to sacrifice some flexibility for the speed and size savings possible with the 6502's instruction set.

When data is pushed on the 6502's stack, the stack pointer determines where the storage address is on the page (most systems have the stack at \$100-\$1FF, although it is possible to put the stack at \$0-FF with some 6502 designs). After storing the byte, the stack pointer is decremented (the stack grows downward) and points to the next available location. By transferring the stack pointer to the X-register (which we've already saved or don't care about), we can absolute index into this page as normal memory.

Examples:

```

next free           $100,X
top of stack       $101,X
second on stack    $102,X
third on stack     $103,X
fourth on stack    $104,X

```

One problem with this technique is the lack of wrap around. Unlike the page zero,X mode, the resulting addresses do *not* wraparound to the beginning of the page. If the base address you are using plus the stack pointer offset sums to more than \$1FF, you'll end up indexing into the \$200-\$2FF page. This is not likely to happen if the stack pointer gets initialized to the top of the page — like \$FF — and you know the stack won't grow all the way down and wrap around. If it does, however, you may end up with a situation where your base address is \$110 (from passing lots of parameters before a subroutine call) and the stack pointer is \$F8. The resulting address is \$208, not \$108. As I said, this is not likely to happen unless the stack pointer is never initialized to a known value. Some systems may not initialize the pointer because it is restricted by hardware to the \$100-\$1FF range; the "unknown stack" or "no RAM stack" conditions of other processors cannot happen and the initialization step might be skipped. User programs should either initialize the stack or be sure of its ranges before using the technique outlined here.

The actual use of this technique in math routines is straightforward. Space is allocated for the returning flags by saving the caller's flags upon entry. The byte at this "semi-absolute address" is then modified according to the results of the math routines and passed back to the caller by popping them off the stack at the end of the code.

Notice that no flags other than the ones used by the routine are altered before they are passed back. The interrupt mask, the break flag, and the decimal flag in effect at entry time will be restored upon exit. Thus, this binary

Listing 1

```

*****
*
* LAWRENCE R. GOLLA'S ORIGINAL
* NTH PRECISION ROUTINES AS
* PUBLISHED IN MICRO 8/80
* PAGES 27-29
*
*****
*
PTR1 EQU $10
PTR2 EQU $12
PTR3 EQU $14
PREC EQU $16
AEND EQU PTR1
AGAND EQU PTR2
ORC $4000
OBJ $4000
*
*
ADD PHA
TYA
PHA
TXA
PHA
LDY PREC
CLC
CLD
CLV
LOOP1 LDA (AEND),Y
ADC (AGAND),Y
STA (PTR3),Y
DEY
BPL LOOP1
BMI OUT
*
SUB PHA
TYA
PHA
TXA
PHA
LDY PREC
CLD
SEC
CLV
LOOP3 LDA (AEND),Y
SBC (AGAND),Y
STA (PTR3),Y
DEY
BPL LOOP3
*
OUT LDY PREC
LDA $00
EOR (PTR3),Y
PHP
BMI NZER
DEY
BMI OUT1
PLP
JMP LOOP2
NZER PLP
ORA $01 SET Z=0
PHP
JMP LOOP4
*
OUT1 PLA
AND $7F
STA $100
INY
LDA (PTR3),Y
EOR $00 ADJUST N-FLAG
PHP
PLA
AND $80
ORA $100 ADD TO FLAGS
STA $100
PLA
TAX
PLA
TAY
PLA
RESET STA $101
LDA $100 GET STATUS
PHA
LDA $101
PLP
RTS
4000: 48
4001: 98
4002: 48
4003: 8A
4004: 48
4005: A4 16
4007: 18
4008: E8
4009: B3
400A: E1 10
400C: 71 12
400E: 91 14
4010: 88
4011: 10 F7
4013: 30 13
4015: 48
4016: 98
4017: 48
4018: 8A
4019: 48
401A: A4 16
401C: E8
401D: 38
401E: B3
401F: B1 10
4021: F1 12
4023: 91 14
4025: 88
4026: 10 F7
4028: A4 16
402A: A9 00
402C: 51 14
402E: 08
402F: 30 07
4031: 88
4032: 30 0B
4034: 28
4035: 4C 2C 40
4038: 28
4039: 09 01
403B: 08
403C: 4C 31 40
403F: 68
4040: 29 7F
4042: 8D 00 01
4045: C8
4046: B1 14
4048: 49 00
404A: 08
404B: 68
404C: 29 80
404E: 0D 00 01
4051: 8D 00 01
4054: 68
4055: AA
4056: 68
4057: A8
4058: 68
4059: 8D 01 01
405C: AD 00 01
405F: 48
4060: AD 01 01
4063: 28
4064: 60

```

Listing 2

```

*****
*
* NTH PRECISION ROUTINES AS
* MODIFIED BY GLENN R. SOGGE
* FANTASY RESEARCH & DEVELOPMENT
* P.O. BOX 203
* EVANSTON, IL 60204
*
* AUGUST 7, 1980
*
*****
*
STACK      EQU   $100
STKLOC     EQU   STACK+4
*
*
*          ORG   $4100
*          OBJ   $4100
*
*
4100: 18      MADD   CLC
4101: B0 38   BCS   #+$3A      HIDES 'SEC' ($38)
*          MSUB   EQU   #-1
*
4103: 08      PHP    SAVE      ALL THE REGISTERS
4104: 48      PHA   INCLUDING ROOM FOR THE STATUS
4105: 8A      TXA
4106: 48      PHA
4107: 98      TYA
4108: 48      PHA
4109: D8      CLD
410A: B8      CLV
410B: A4 16   LDY   PREC
410D: B0 0B   BCS   MSUB1      C STILL SET FROM ENTRY
*
410F: B1 10   MADD1  LDA   (PTR1),Y
4111: 71 12   ADC   (PTR2),Y
4113: 91 14   STA   (PTR3),Y
4115: 88      DEY
4116: 10 F7   BPL   MADD1
4118: 30 09   BMI   MOUT
*
411A: B1 10   MSUB1  LDA   (PTR1),Y
411C: F1 12   SBC   (PTR2),Y
411E: 91 14   STA   (PTR3),Y
4120: 88      DEY
4121: 10 F7   BPL   MSUB1
*
4123: 08      MOUT   PHP
4124: 68      PLA   RESET      N & Z (=0) BUT
4125: 29 7D   AND   #$7D      SAVE C & V
4127: BA      TSX   GET       POINTER TO STASH
4128: 9D 04 01 STA   STKLOC,X  STORE IN ORIGINAL P SAVED
412B: A4 16   LDY   PREC
*
412D: B1 14   ZCHK   LDA   (PTR3),Y
412F: D0 0B   BNE   NCHK      LEAVE AS SOON AS FIND <>0
4131: 88      DEY
4132: 10 F9   BPL   ZCHK      KEEP LOOKING
4134: BD 04 01 ZFLG   LDA   STKLOC,X  X STILL SET
4137: 09 02   ORA   #$02      MAKE Z=1
4139: 9D 04 01 STA   STKLOC,X
*
413C: A0 00   NCHK   LDY   #$00
413E: B1 14   LDA   (PTR3),Y
4140: 10 0B   BPL   EXIT      LEAVE N=0
4142: BD 04 01 NFLG   LDA   STKLOC,X
4145: 09 80   ORA   #$80
4147: 9D 04 01 STA   STKLOC,X  MAKE N=1
*
414A: 68      EXIT   PLA
414B: A8      TAY
414C: 68      PLA
414D: AA      TAX
414E: 68      PLA
414F: 28      PLP   PULL      FLAGS AS MODIFIED
4150: 60      RTS   AND       EXEUNT
*
*          ORG   $4200
*          OBJ   $4200
*

```

math routine could be called by a decimal math program and not interfere with the main program. [Interpreting the results is another matter.]

[A modification of these routines would be to NOP the CLD instruction to allow the code to work in whichever

base was in effect for the calling program or to change the CLD to a SED for decimal operands and results. The N and V flags will not be correct if decimal is the base in effect when the code runs, but the answers and the C and Z flags will still be right.]

Code Sharing and Duplication

The original routines duplicate quite a bit of set-up code at their beginnings (saving registers, clearing flags getting the precision, etc.). In fact, the only differences are in the setting of the carry flag. By setting the carry flag appropriately as the first action upon entry, the duplicate code can be shared and then branched out of on the basis of the carry — if it's clear, add; if it's set, subtract

The very first bytes are a tricky technique I picked up from some of the Apple peripheral card firmware. Entry a the first byte clears the carry and then encounters a branch instruction it will never take (BCS — branch if set) and falls through into the main code. The second byte of the branch instruction contains the value of the SEC opcode (\$38 — the value in the source listing is necessary to get my assembler to calculate the correct value). Entering at this third byte will set the carry and then fall into the common code. The entry points are Origin + \$00 for adding and Origin + \$02 for subtracting. (I find close entry points easier to remember than ones spaced farther apart.)

This bit of trickery saves one byte of code that could be crucial in a small ROM driver by compressing a sequence like

```

ENTRY1 CLC
          BCC MAIN
ENTRY2 SEC
MAIN     ...
          ...

```

of 4 bytes into 3 bytes. In addition, assuming the flag doesn't get modified by the main code, selective initialization or function selection is possible further down the road.

What We Have Gained

All of this is only of theoretical interest if there isn't some practical result. The clearest gain is a reduction of memory size from 101 bytes to 81 bytes without any loss of function and an increase in portability. There is also an improvement in speed but this isn't quite as clear-cut.

The test routines included in the listings were some of the code and conditions I used for quantifying the results. In the examples given, one of the worst case situations is executed. Two 128-byte zeros are added together, checked for a zero result, and the flags appropriately set. This is done 256 times before hitting the BRK's. With Golla's code, each of the 256 adds takes about

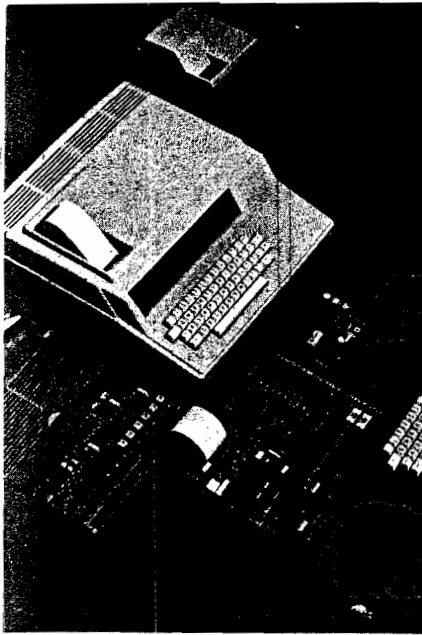

TAKE AIM.

Unique Data Systems has. We've taken Rockwell's AIM 65 Microcomputer, packaged it in a professional enclosure and turned it into a versatile, higher capacity microcomputer system. Complete with a memory-I/O board, modem board or wire wrap prototyping board, power supply, cables and connectors. It makes the AIM 65 a joy to work with, and there's even space inside for your own special circuitry. We'll sell you the whole package or just the bits and pieces you need for your application. We're AIM 65 specialists. We're Unique Data Systems.

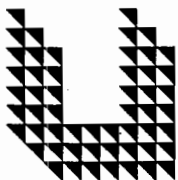

Unique Data Systems
15041 Moran Street
Westminster, CA 92603
(714) 895-3455

Listing 3

```

*****
*
* TESTING ROUTINES
*
*****
*
4200: A2 43      SETPTRS  LDX  #43
4202: 86 11      STX  PTR1+1
4204: E8         INX
4205: 86 13      STX  PTR2+1
4207: E8         INX
4208: 86 15      STX  PTR3+1
420A: A0 00      LDY  #00
420C: 84 10      STY  PTR1
420E: 84 12      STY  PTR2
4210: 84 14      STY  PTR3
4212: A9 7F      LDA  #7F      MAXIMUM PRECISION
4214: 85 16      STA  PREC
4216: A9 00      LDA  #00
4218: A0 00      LDY  #00
421A: 91 10      CLRLOOP  STA  (PTR1),Y
421C: 91 12      STA  (PTR2),Y
421E: 91 14      STA  (PTR3),Y
4220: C8         INY
4221: 10 F7      BPL  CLRLOOP
4223: 60         RTS

*
4224: 20 00 42   ADDTST  JSR  SETPTRS  NULL EVERYTHING
4227: A2 00      LDX  #00
4229: 20 00 40   ADLP1   JSR  ADD
422C: CA         DEX
422D: D0 FA      BNE  ADLP1      ADD 0 TO ITSELF 256 TIMES
422F: 00         BRK

*
4230: 20 00 42   ADDT2   JSR  SETPTRS
4233: A2 00      LDX  #00
4235: 20 00 41   ADLP2   JSR  MADD
4238: CA         DEX
4239: D0 FA      BNE  ADLP2      SAME AS ABOVE
423B: 00         BRK

*
60 BYTES GENERATED THIS ASSEMBLY

```

.0059 seconds (5.9 milliseconds); with my code, each takes about .0049 seconds (4.9 milliseconds). (The multiple execution was to allow stopwatch timing to at least be in the ball park.) For these cases, all of the bytes of the result had to be examined before the zero flag could be properly set.

As a further test of the differences between the routines, I set them up to add zero and 1 (both 128-byte precision). Here the differences were much more substantial — Golla's code still took around 6 milliseconds per result while mine ran in about 3.3 milliseconds. This shows the effect of changing the algorithm because the code is almost identical except for checking the result for zero.

The rewritten code runs at times that are proportional to both the amount of precision and the result but the original code runs at speeds only proportional to the precision.

When and What to Optimize

As I said at the beginning, this article started out as a few thoughts about optimizing; obviously it's expanded considerably. Golla's routines seemed like a good place to illustrate some of the techniques and results of optimization.

Not all code can be optimized in these ways and some shouldn't be. Saving three bytes and 15 microseconds is not important if you have 4K of extra RAM and the routine is dependent on user reaction time — the sweat just isn't worth it.

These math routines were good candidates though because the optimization worked on the loops where most of the execution time is spent. With the size of the code, tools should only be big enough to do their job (if they're too big, you may have to exclude another useful tool from your program). Tools like these routines should be optimized because they are likely to be used more often than their size would indicate. Number-crunching is slow enough as it is; the design of the code shouldn't impede it even more.

Some analysts estimate that 80% of the execution time is spent in 20% of the code. That 20% is where the optimization should be done.

Glenn R. Sogge is a 30 year old former composer with a degree in Art and 7½ years of retail business experience. He has become fascinated and infatuated with those electronic crossword puzzles that are called computers.

MICRO

What's Where in the apple?

By William F. Luebbert

Adjunct Professor of Engineering, Dartmouth College

The **MOST DETAILED** description to date of Apple II Firmware and Hardware.

● This Atlas and Gazetteer of **PEEKs**, **POKEs**, and **CALLs** lists in tabular form over 2000 memory locations.

● Information is presented numerically in the Atlas and alphabetically in the Gazetteer.

● The names and locations of various **Monitor**, **DOS**, **Integer BASIC**, and **Applesoft** routines are listed, and information is provided on their use.

● The easy to use format includes:

The address in hexadecimal (useful for assembly programming): **\$FC5B**

The address in signed decimal (useful for BASIC programming): **(-936)**

The common name of the address or routine: **[HOME]**

Information on the use and type of routine: **\SE**

A description of the routine: **CLEAR SCROLL WINDOW TO BLANKS.**

SET CURSOR TO TOP LEFT CORNER

Related register information: **{A- Y-REGS ALTERED}**

This reference tool offers information every serious Apple user needs. BASIC and assembly language users alike will find the book helpful in understanding the Apple.

Approximately 128 pages, 8-1/2 x 11 inches, cardstock cover, Wire-O binding. Publication: August 1981
\$14.95*

24-Hour Toll-free Service

VISA and Mastercard Accepted

800-227-1617 Ext. 564

In California call 800-772-3545 Ext. 564

MICRO

34 Chelmsford Street P.O. Box 6502 Chelmsford, MA 01824

*After Sept. 30, 1981, add \$2.00 for surface shipping. Massachusetts residents add 5% sales tax.

AN ATLAS FOR THE APPLE COMPUTER

The program sent disassembled instructions to a VIA port. Since I wanted to be able to edit and re-assemble the disassembled code, my program disassembles one-instruction-at-a-time, reads the print buffer, and writes the ASCII instruction code and operand to specified memory locations. Then, the Text Editor can be entered to allow listing or modification of the source code. The resulting file contains a source program which can serve as input to the Assembler.

The first line of the generated source file is an assembly language command which sets the program counter to the original location of the object code. The remainder of the file contains lines of the symbolic instruction codes and operands in Assembler-compatible format. The instruction address and hex opcode, contained in the original output of the disassembler, are deleted, while the mnemonic instruction code and any operands are retained. Each line is terminated with a carriage return character (\$OD) and the entire file is terminated with the Assembler ".END" directive and the Editor's text-end character (\$00).

Since the disassembler outputs operands in hexadecimal format without the hex symbol (\$), this symbol is added where appropriate. Also, the accumulator addressing mode is indicated by ".A" on the initial disassembled output. The "." is removed from the final output file to allow subsequent input to the Assembler.

The assembly listing and symbol table for this program are presented in listings 1 and 2. The program can be relocated by simply changing the program origin.

Executing the Program

When the program is executed, "TO=" is displayed. The beginning location for storage of disassembled code should be entered; this will be the beginning of the Editor text buffer. The user is then requested by the program to enter the "EDITOR END" which is the ending address for the Editor text buffer. Next, the beginning location of the code to be disassembled is entered in response to the displayed message "FROM=". Finally, enter the number of instructions to be disassembled (two digit decimal number; return, space, or "." = "01 instruction). After disassembly of up to 99 (decimal) instructions, the message "MORE?" will be displayed. The user can enter "Y" to continue disassembling, or enter any other character to quit.

```

OE2C 85E6          STA END+1
OE2E 3B           SEC
OE2F A5E5         LDA END
OE31 E901         SBC #$01
OE33 85E5         STA END
OE35 B002         BCS CNTINU
OE37 C6E6         DEC END+1
OE39 2013EA      CNTINU JSR CRLW
OE3C 20A3E7      JSR FROM          ;DISASSEMBLE WHERE?
OE3F              ;
OE3F              ;SET UP PROGRAM ORIGIN
OE3F              ;
OE3F A92A         LDA '*'
OE41 20100F      JSR ADINC
OE44 A93D         LDA '='
OE46 20100F      JSR ADINC
OE49 A924         LDA '$'
OE4B 20100F      JSR ADINC
OE4E AD1DA4      LDA ADDR+1
OE51 20FC0E      JSR TOASCI
OE54 AD1CA4      LDA ADDR
OE57 20FC0E      JSR TOASCI
OE5A A90D         LDA #$0D
OE5C 20100F      JSR ADINC
OE5F              ;
OE5F 20D7E5      JSR $E5D7          ;SAVE ADDRESS FOR DISASSEMBLER
OE62              ;
OE62              ;READ # OF INSTRUCTIONS (DECIMAL 1-99)
OE62              ;
OE62 2037E8      HOWNY JSR PSL1
OE65 205DEA      JSR RD2
OE68 B0F8         BCS HOWNY
OE6A 4B          PHA
OE6B 2024EA      JSR CRCK
OE6E              ;
OE6E              ;DISASSEMBLE ONE INSTRUCTION
OE6E              ;
OE6E A901         DIS1  LDA #$01
OE70 8D19A4      STA COUNT
OE73 206CF4      JSR DISASM
OE76              ;
OE76              ;SKIP PC AND OP CODE
OE76              ;
OE76 A209         LDX #$09
OE78 BD60A4      RDBUF LDA PRIBUF,X
OE7B E00C         CPX #$0C
OE7D              ;PUT BLANK BETWEEN MNEMONIC AND ADDRESS--SKIP OTHER BLANKS
OE7D F018         BEQ STORE
OE7F B005         BCS SPACE
OE81 297F         AND #$7F          ;STRIP MSB FROM MNEMONIC
OE83 4C970E      JMP STORE
OE86 C920         SPACE CMP #$20
OE88 F026         BEQ NEXTX
OE8A E00D         CPX #$0D          ;CHECK FOR ADDRESS FIELD
OE8C D009         BNE STORE
OE8E C923         CMP #$23          ;IF '#', STORE IT AND STORE HEX SYMBOL
OE90 D00B         BNE PAREN
OE92 20100F      HXSYM JSR ADINC
OE95 A924         LDA '$'
OE97 20100F      STORE JSR ADINC
OE9A 4C80E        JMP NEXTX
OE9D              ;
OE9D              ;IF '(' STORE IT AND STORE HEX SYMBOL
OE9D              ;
OE9D C928         PAREN CMP '('
OE9F F0F1         BEQ HXSYM
OEA1 C92E         CMP #$2E          ;SKIP IF '.'
OEA3 F00B         BEQ NEXTX
OEA5              ;
OEA5              ;NOT '#', '.', OR '('--
OEA5              ;MUST BE ADDRESS, SO
OEA5              ;STORE HEX SYMBOL FIRST.
OEA5              ;
OEA5 A924         LDA '$'
OEA7 20100F      JSR ADINC
OEA8 BD60A4      LDA PRIBUF,X
OEA9 4C970E      JMP STORE
OEB0 E8          NEXTX INX
OEB1 E014         CPX #$14
OEB3 D0C3         BNE RDBUF
OEB5 A90D         LDA #$0D          ;OUTPUT CR AS LAST CHARACTER
OEB7 20100F      JSR ADINC
OEB8 202EE7      JSR $E72E

```

(Continued)

```

OEBD      ;
OEBD      ;ARE WE DONE?
OEBD      ;
OEBD 68          PLA
OEBE 8D19A4      STA COUNT
OEC1 2090E7      JSR DONE
OEC4 4B          PHA
OEC5 D0A7        BNE DIS1
OEC7          ;
OEC7          ;DISASSEMBLE MORE?
OEC7          ;
OEC7 A01C        LDY #M5-M1          ;MORE?
OEC9 2070E9      JSR KEPR
OECB C959        CMP 'Y
OECE D003        BNE ADDEND
OED0 4C620E      JMP HOWMNY
OED3          ;
OED3          ;ADD '.END'
OED3          ;
OED3 2013EA      ADDEND JSR CRLW
OED6 A200        LDX #00
OED8 B03D0F      ENDING LDA MSG,X
OEDB 20100F      JSR ADINC
OEDE E003        CPX #03
OEE0 F004        BEO FINISH
OEE2 E8          INX
OEE3 4CD80E      JMP ENDING
OEE6          ;
OEE6          ;CLOSE FILE, RECORD BOTTOM LINE
OEE6          ;AND ENTER MONITOR
OEE6          ;
OEE6 A90D        FINISH LDA #0D
OEEB 20100F      JSR ADINC
OEEB A900        LDA #00
OEED A000        LDY #00
OEEF 9100        STA (TOLO),Y
OEF1 A500        LDA TOLO
OEF3 85E1        STA BOTLN
OEF5 A501        LDA TOHI
OEF7 85E2        STA BOTLN+1
OEF9 4C82E1      JMP START
OEFB          ;
OEFB          ;CONVERT 2 HEX CHARACTERS TO ASCII
OEFB          ;
OEFB 48          TOASCII PHA
OEFD 4A          LSR
OEFE 4A          LSR
OEFF 4A          LSR
OF00 4A          LSR
OF01 20070F      JSR CNVRT
OF04 68          PLA
OF05 290F        AND #0F
OF07 18          CNVRT CLC
OF08 6930        ADC '0
OF0A C93A        CMP #03A          ;'9' + 1
OF0C 9002        BCC ADINC
OF0E 6906        ADC #06
OF10          ;
OF10          ;STORE CHAR AND INC ADDRESS
OF10          ;
OF10 A000        ADINC LDY #00
OF12 9100        STA (TOLO),Y
OF14 E600        INC TOLO
OF16 D002        BNE TEST
OF18 E601        INC TOHI
OF1A A500        TEST LDA TOLO
OF1C C5E5        CMP END
OF1E D01C        BNE RETURN
OF20 A501        LDA TOHI
OF22 C5E6        CMP END+1
OF24 D016        BNE RETURN
OF26 2013EA      JSR CRLW
OF29 203EE8      JSR BLANK
OF2C A06C        LDY #EMSGA-M1
OF2E 20AFE7      JSR KEP
OF31 203EE8      JSR BLANK
OF34 A072        LDY #EMSGB-M1
OF36 20AFE7      JSR KEP
OF39 4CE60E      JMP FINISH
OF3C 60          RETURN RTS
OF3D          ;
OF3D 2E454E      MSG ASC '.END'
OF40 44

```

When disassembly is complete, or when the text buffer is filled, the buffer limits and last active line parameters are set up for the Editor, and the program control jumps to the AIM monitor. The user can then enter the Editor with the monitor "T" command to examine and edit the generated source file, and then use this file as input to the Assembler. If the text buffer becomes filled during disassembly, disassembly stops, the message "EDITOR END" is displayed, and the monitor is entered.

I have found this program to be particularly useful for accessing and editing sections of code from the AIM monitor ROM for inclusion in my programs. Listing 1 presents a sample run of my disassemble-to-memory program with the disassembly of a short monitor routine. The listing includes the output of the AIM disassembler during program execution, followed by an editor listing of the generated source file.

This program can be used any time it is necessary to alter a program which is available only in object code. As such, Disassembling-To-Memory is a useful utility for AIM microcomputer systems.

Figure 2: Sample run of the disassembling to memory program. Prior to execution the AIM printer was toggled to "ON", so that the listing includes the program dialogue and the output of the AIM disassembler. This is followed by an entry to the AIM Editor with the "T" command and a listing of the program generated source file.

```

* =0E00
0 /
TO =0000
EDITOR END =0D00
FROM =EA46
/10
EA46 48 PHA
EA47 4A LSR A
EA48 4A LSR A "
EA49 4A LSR A "
EA4A 4A LSR A "
EA4B 20 JSR EA51
EA4E 68 PLA
EA4F 29 AND #0F
EA51 18 CLC
EA52 69 ADC #30
MORE?Y 04
EA54 C9 CMP #3A
EA56 90 BCC EA5A
EA58 69 ADC #06
EA5A 4C JMP E9BC
MORE?N
T
* = $EA46
= L

```

(Continued)

Figure 2 (Continued)

```

/
OUT=R
*= $EA46
PHA
LSR A
LSR A
LSR A
LSR A
JSR $EA51
PLA
AND #$0F
CLC
ADD #$30
CMP #$3A
BCC $EA5A
ADD #$06
JMP $E9BC
END

```

Larry Gonzalez is an Assistant Professor of physiology and biophysics at the University of Illinois Medical Center. He has 12 years of programming experience in high-level languages and several years in the use of minicomputers for real-time data acquisition and signal analysis. During the last two years he has been developing a system using an AIM 65 in the collection and analysis of electrophysiological data.



CBM/PET? SEE SKYLES ... CBM/PET?

SEE SKYLES... CBM/PET? SEE SKYLES

PET? SEE SKYLES ... CBM/PET? SEE SKYLES

“They laughed when I sat down at my PET and immediately programmed in machine language... just as easily as writing BASIC.”

With the new Mikro, brought to you from England by Skyles Electric works, always searching the world for new products for PET/CBM owners. A 4K machine language assembler ROM that plugs into your main board. At just \$80.00 for the Mikro chip, it does all the machine language work for you; all you have to do is start laying down the code.

The Mikro retains all the great screen editing features of the PET... even all the Toolkit commands. (If you own a Toolkit, of course.) Sit down and write your own machine language subroutine. The program you write is the source code you can save. And the machine language monitor saves the object code. The perfect machine language answer for most PET owners and for most applications. (Not as professional as the Skyles MacroTeA... not as expensive, either.)

A great learning experience for those new to machine language programming but who want to master it easily. Twelve-page manual included but we also recommend the book, "6502 Assembler Language Programming," by Lance A. Leventhal at \$17.00 direct from Skyles.

Skyles guarantees your satisfaction: if you are not absolutely happy with your new Mikro, return it to us within ten days for an immediate, full refund.

Skyles Mikro Machine language assembler.....\$80.00
 "6502 Assembler Language Programming" by Leventhal..... 17.00
 Shipping and Handling.....(USA/Canada) \$2.50 (Europe/Asia) \$10.00
 California residents must add 6%/6 1/2% sales tax, as required.



Skyles Electric Works
 231E South Whisman Road
 Mountain View, California 94041
 (415) 965-1735

Visa/Mastercard orders: call tollfree (800) 227-9998 (except California). California orders: please call (415) 965-1735.

... CBM/PET? SEE SKYLES ... CBM/PET? SEE SKYLES

GET FREE SOFTWARE FOR YOUR APPLE!!!

HOW? Just order any of the items below, and for every \$100 worth of merchandise order an item from the Bonus Software Section at NO COST! C.O.D. & Personal Checks accepted for all orders.

HARDWARE BY APPLE	VIDEO MONITORS	SOFTWARE by Others
APPLE II PLUS, 48k 1199	Leedex-Video-100 12" B&W w/Cable 139	PEACHTREE BUSINESS SOFTWARE CALL
DISK DRIVE+CONTROLLER (3.3) 535	Leedex 12" Green w/Cable 165	VISICALC 120
DISK DRIVE only 445	Leedex 13" COLOR MONITOR & cable 399	EZ WRITER PROF. SYSTEM 229
Language System w. Pascal 387		APPLE FORTRAN by MICROSOFT 159
Silentype Printer & Interface 549		APPLE BASIC COMPILER by MICROSOFT 315
Integer or Applesoft Firmware Card 159		APPLE COBOL by MICROSOFT 599
Graphics Tablet 645		MUSE SUPER-TEXT II 139
Parallel Printer Interface Card 149		PROGRAMMA APPLE PIE 119
Hi-Speed Serial Card 155		
	SOFTWARE by APPLE	
	APPLE FORTRAN 159	
	APPLE PILOT 125	
HARDWARE by Others	HARDWARE by Mountain Computer	PRINTERS
HAYES MICROMODEM II 300	Clock/Calendar Card 239	EPSON MX-80 515
VIDEX VIDEOTERM 80 W. GRAPHICS 320	A/D & D/A Interface 319	EPSON MX-70 W. GRAPHICS 415
MICROSOFT Z80 SOFTCARD 269	Expansion Chassis 555	CENTRONICS 737 737
MICROSOFT 16k RAMCARD 159	ROMplus Card 135	NEC SPINWRITER 5510 RO 2795
CORVUS 10MB HARD DISK CALL	Mark Sense Card Reader 995	VISTA V300 DAISY WHEEL 25CPS 1750
SSM AIO SERIAL/PARALLEL A&T 189		VISTA V300 DAISY WHEEL 45CPS 2025
MICRO-SCI Disk & Controller 495		

BONUS SOFTWARE HERE!

Let us acquaint you with MESSAGE-MAKING SOFTWARE. Just place the disk in the APPLE, enter the text, and colorful, dynamic messages appear on the screens of TV sets connected to the computer. Use the software to broadcast messages on TV screens in schools, hospitals, factories, store windows, exhibit booths, etc. The following program is our latest release:
SUPER MESSAGE: Creates messages in full-page "chunks". Each message allows statements of mixed typesets, typesizes and colors, in mixed upper and lower case. Styles range from regular APPLE characters, up to double-size, double-width characters with a heavy, bold font. Six colors may be used for each different typestyle. Vertical and horizontal centering are available, and word-wrap is automatic. Users can chain pages together to make multi-page messages. Pages can be advanced manually or automatically. Multi-page messages can be stored to disc or recalled instantly.
 REQUIRES 48K & ROM APPLESOFT..... \$ 50.

APPLE PLOTS YOUR DATA & KEEPS YOUR RECORDS TOO
APPLE DATA GRAPH 2.1: Plots up to 3 superimposed curves on the Hi-res Screen both the X & Y axes dimensioned. Each curve consists of up to 120 pieces of data. Graphs can be stored to disc and recalled immediately for updating. Up to 100 graphs can be stored on the same disc. Great for Stock-market Charting, Business Management, and Classroom instruction!
 REQUIRES 48 K & ROM APPLESOFT..... \$ 40.
APPLE RECORD MANAGER: Allows complete files to be brought into memory so that record searches and manipulations are instantaneous. Records within any file can contain up to 20 fields, with user-defined headings. Information can be string or numeric. Users can browse thru files using page-forward, page-backward or random-search commands. Records can easily be searched, altered or sorted at will. Files can be stored on the same drive as the master program, or on another, if a second drive is available. Records or files can be printed, if desired. Additional modules coming are a STATISTICS INTERFACE, CHECKBOOK, MAILING LIST & DATA-ENTRY..... \$ 35.
 REQUIRES 48K & ROM APPLESOFT..... \$ 35.
 * All Software above on Disk for APPLE DOS 3.2, convertible to 3.3.

Sorting

An application of Quicksort to sort a file where the individual members cannot be moved. The indexes of the individual members are moved to implement the sort.

William R. Reese
6148 Persimmon Tree Court
Englewood, Ohio 45322

In the July 1980 issue of MICRO (26:13), the article on sorting by Richard Vile interested me. I was looking for a faster sort for my mailing list programs. That article assumed that you can move the numbers or names that you are sorting. In my mailing list programs, I cannot do that. I work with files of 200 to 400 names and addresses on several mailing lists that are on disk. However, I took the quicksort listed on page 28, changed it from Integer BASIC to Applesoft BASIC, and modified it to sort on an index rather than sort on the numbers and/or names themselves.

While I was doing this conversion, I remembered that the post office was planning to change zip codes from 5 to 9 digits. Since my mailing programs sorted by zip before printing the labels, I used nine-digit zip codes for testing during the conversion process.

When I want to sort a group, a Sort Sequence Index (see line 103 of listing 1 for SS%) is used. This way I can move these sequence numbers instead of moving the actual file on the disk. In modifying the Apple Quicksort in Mr. Vile's article, I tried to keep the line numbers the same for easy cross reference. This helped a lot while I debugged the program.

The finished conversion product is given in listing 1. (Figure 1 is a list of variables and purpose, and figure 2 is for

```
Listing 1

10 REM QUICKSORT FOR INDEXES
20 REM QUICK SORT P26:28 MICRO JULY 1980
30 REM PRINT LINES 162 & 185 MAY BE REMOVED
90 INPUT "NUMBER TO BE SORTED: ";N
94 DIM SK(20)
95 DIM V$(N+1),SSZ(N+1)
99 REM TEST FOR SORT FOR NINE DIGIT ZIP CODES
100 FOR I = 1 TO N
103 SSZ(I) = I
105 V$(I) = "4": FOR J = 0 TO 8:V$(I) = V$(I) + STR$(INT(10 * RN
D(1))) : NEXT J
106 PRINT V$(I)
110 NEXT I: PRINT
M112 REM SORT STARTS HERE
113 REM ALSO See LINES 94-95
Q15 V$(N+1) = "999999999":SSZ(N+1) = N+1
116 V$(0) = " ":SSZ(0) = 0: REM THESE VALUES INCLUDED BECAUSE LINE
100 STARTS WITH I=1
120 P = 1:Q = N:ST = 0
130 IF P >= Q THEN 170
135 K = Q + 1:GOSUB 1145
140 IF J - P < Q - J THEN 150
145 GOSUB 400:GOTO 160
150 GOSUB 500
160 ST = ST + 2
162 PRINT "TOP= ";ST; TAB(10);"P= ";P; TAB(17);"Q= ";Q
165 GOTO 130
170 IF ST = 0 THEN 200
180 Q = SC(ST):P = SK(ST-1)
185 PRINT "TOP= ";ST; TAB(10);"P= ";P; TAB(17);"Q= ";Q
190 ST = ST - 2:GOTO 130
200 FOR I = 0 TO N: PRINT I; TAB(5);SSZ(I); TAB(10);V$(SSZ(I)): NE
XT
201 END
400 SK(ST+1) = P:SK(ST+2) = J - 1:P = J + 1: RETURN
500 SK(ST+1) = J + 1:SK(ST+2) = Q:Q = J - 1: RETURN
1145 VI = SSZ(P):VH$ = V$(NI):I = P:J = K
1160 J = J - 1: IF V$(SSZ(J)) <= VH$ THEN 1170
1165 GOTO 1160
1170 I = I + 1: IF V$(SSZ(I)) >= VH$ THEN 1180
1175 GOTO 1170
1180 IF J <= I THEN 1200
1190 GA = SSZ(I):GB = SK(J)
1195 SSZ(I) = GB:SSZ(J) = GA:GOTO 1160
1200 SSZ(P) = SSZ(J):SSZ(J) = VI: RETURN
```

those who are familiar with the article noted above.) Lines 90-110 are used to generate 9-digit zip codes that start with 4. The important difference between this program and Mr. Vile's is the subroutine starting at 1145. Notice that the comparisons are based on the Sort Sequence Index (SS%) instead of the numbers themselves. Compare figure 3 copied from the original article.

As you can see in the sample run (run 1) 20 numbers were randomly created. The numbers themselves were

not moved, but the Sort Sequence Index was. The smallest zip code the sort found had an index of 17, and the largest had an index of 4. I then ran this program three times with 200, 300, and 400 numbers. The largest number TOP became was 12. Line 94 reflects this discovery.

My next project was to apply this Quicksort to handle multifield sorts, i.e., sorting a mailing list by last name, then the first name. In this example the last name is called the primary sort and

the first name would be the secondary sort. In listing 2, V\$ is the primary sort and W\$ is the secondary sort.

The differences between listing 1 and listing 2 are in three areas:

1. The generation of the numbers to be sorted (lines 94-115),
2. the printout at the end of the program (line 200),
3. the comparisons in subroutine 1145 (lines 1160-1172).

In lines 94 through 115, I created a one-digit number V\$ as the primary sort field and a 9-digit zip code for the secondary sort field. Line 200 was changed to print out both V\$ and W\$. Lines 1160-1162 and 1170-1172 are tricky. Compare lines 1160-1165 in listing 1 to those in listing 2. To understand this, just remember that you must go back to line 1160 whenever J is high, and go to 1170 when J is low or equal.

If you get to line 1162 then V\$(SS%(J)) = VH\$ and you test your secondary sort field. If you have more than 2 sort fields, then you repeat the logic in 1160-1161 over until you get to your last sort field. Then the last sort field is handled just like W\$ is, in line 1162.

In one of my applications I have 4 sort fields. If the program finds two records with all 4 sort fields equal, then the program stops, because in that application no two records should be exactly the same.

Lines 1170-1172 have been modified just like lines 1160-1162. A sample run with 20 pairs of numbers is given as an example of this program (run 2).

I hope that this article has helped you to sort out your problems with sorts when you cannot move the entries themselves in the sorting process.

Bill Reese has a Master of Mathematics from Cleveland State University. He is a computer specialist for the U.S. Air Force at Wright Patterson Air Force Base. He owns an Apple II which he uses to support a newsletter mailing list for his church's singles club. He has also computerized his model railroad's waybills and switching lists.

Figure 1

Vile's Article	My Listing	Purpose
TOP	ST	Point to top of stack
STACK	SK	STACK of partitions to sort
A(I)	V\$(I)	Field to be sorted
V	VH\$	Hold field for comparisons
TEMP	GA,GB	Temporary holders

Figure 2

Variable	Purpose
I,P	Local variable, low number of partition
N	Number of items
J,Q	Local variable, high number of partition
SK	Stack of partitions to sort
SS%	Sort Sequence Index (Integer Variable)
ST	Point to top of stack
V\$	Primary sort field
VH\$	Hold field for comparison
VI	Hold index for comparison
W\$	Secondary sort field

Figure 3

```

1145 VH$ = V$(P):I = P:J = K
1160 J = J - 1:IF V$(J) < = VH$
      THEN 1170
1165 GO TO 1160
1170 I = I + 1:IF V$(I) > = VH$
      THEN 1180
1175 GO TO 1170
1180 IF J < = I THEN 1200
1185 TEMP = V$(I)
1186 V$(I) = V$(J)
1188 V$(J) = TEMP
1199 GO TO 1160
1200 V$(P) = V$(J)
1202 V$(J) = VH$
1999 RETURN
  
```

Run 1

```

NUMBER TO BE SORTED: 20
457188910
469927789
469026711
495696624
493153727
451635537
461576650
459036737
448501656
429879597
  
```

(Run 1 continued)

```

459573279
476600802
440954747
408470923
450983254
486018953
402300858
475895981
408563191
490375116
  
```

```

TOP= 2   P= 1   Q= 8
TOP= 4   P= 7   Q= 8
TOP= 6   P=P9  Q= 8
TOP= 6   P= 7   Q= 7
TOP= 4   P= 1   Q= 5
TOP= 4   P= 6   Q= 5
TOP= 4   P= 1   Q= 4
TOP= 4   P= 1   Q= 1
TOP= 4   P= 3   Q= 4
TOP= 4   P= 3   Q= 2
TOP= 4   P= 4   Q= 4
TOP= 2   P= 10  Q= 20
TOP= 2   P= 10  Q= 9
TOP= 2   P= 11  Q= 20
TOP= 2   P= 11  Q= 10
TOP= 2   P= 12  Q= 20
TOP= 2   P= 17  Q= 20
TOP= 4   P= 17  Q= 16
TOP= 4   P= 18  Q= 20
TOP= 4   P= 21  Q= 20
TOP= 4   P= 18  Q= 19
TOP= 4   P= 18  Q= 17
TOP= 4   P= 19  Q= 19
TOP= 2   P= 12  Q= 15
TOP= 2   P= 12  Q= 12
TOP= 2   P= 14  Q= 15
TOP= 2   P= 14  Q= 13
TOP= 2   P= 15  Q= 15
0       0
1       17   402300858
2       14   408470923
3       19   408563191
4       10   429879597
5       13   44095747
6       9    448501656
7       15   450983254
8       6    451635537
9       1    457188910
10      8    459036737
11      11   459573279
12      7    461576650
13      3    469026711
14      2    469927789
15      18   475895981
16      12   476600802
17      16   486018953
18      20   490375116
19      5    493153727
20      4    495696624
  
```

(Continued)

Listing 2

```

1  REM *****
10  REM QU SORT IND 2 SORT FIELDS
20  REM QUICK SORT P26:28 MICRO JULY 1980
30  REM PRINT LINES 162 & 185 MAY BE REMOVED
90  INPUT "NUMBER TO BE SORTED: ";N
94  DIM SK(20)
95  DIM V$(N + 1),SSZ(N + 1),W$(N + 1)
99  REM TEST FOR SORT FOR NINE DIGIT ZIP CODES
100 FOR I = 1 TO N
103 SSZ(I) = I
104 V$(I) = STR$(INT(10 * RND(1)))
105 W$(I) = "4": FOR J = 1 TO 8:W$(I) = W$(I) + STR$(INT(10 * RND(1)))
106 PRINT I; TAB(5);SSZ(I); TAB(10);V$(SSZ(I)); TAB(20);W$(SSZ(I))
110 NEXT I: PRINT
112 REM SORT STARTS HERE
113 REM ALSO SEE LINES 94-95
115 V$(N + 1) = "9":SSZ(N + 1) = N + 1:W$(N + 1) = "9":
116 V$(0) = "0":W$(0) = "0":SSZ(0) = 0: REM THESE VALUES INCLUDED BEC
AUSE LINE 100 STARTS WITH I=1
120 P = 1:Q = N:ST = 0
130 IF P > = Q THEN 170
135 K = Q + 1: GOSUB 1145
140 IF J - P < Q - J THEN 150
145 GOSUB 400: GOTO 160
150 GOSUB 500
160 ST = ST + 2
162 PRINT "TOP= ";ST; TAB(10);"P= ";P; TAB(17);"Q= ";Q
165 GOTO 130
170 IF ST = 0 THEN 200
180 Q = SK(ST):P = SK(ST - 1)
185 PRINT "TOP= ";ST; TAB(10);"P= ";P; TAB(17);"Q= ";Q
190 ST = ST - 2: GOTO 130
200 FOR I = 1 TO N: PRINT I; TAB(5);SSZ(I); TAB(10);V$(SSZ(I)); TAB(20);W$(SSZ(I)): NEXT I
201 END
400 SK(ST + 1) = P:SK(ST + 2) = J - 1:P = J + 1: RETURN
500 SK(ST + 1) = J + 1:SK(ST + 2) = Q:Q = J - 1: RETURN
1145 VI = SSZ(P):VH$ = V$(VI):I = P:J = K
1160 J = J - 1: IF V$(SK(J)) < VH$ THEN 1170
1161 IF V$(SSZ(J)) > VH$ GOTO 1160
1162 IF W$(SSZ(J)) < W$(VI) GOTO 1170
1165 GOTO 1160
1170 I = I + 1: IF V$(SSZ(I)) > VH$ THEN 1180
1171 IF V$(SSZ(I)) < VH$ GOTO 1170
1172 IF W$(SSZ(I)) > W$(VI) GOTO 1180
1175 GOTO 1170
1180 IF J < = I THEN 1200
1190 GA = SSZ(I):GB = P:SSZ(J)
1195 SSZ(I) = GB:SSZ(J) = GA: GOTO 116P
1200 SSZ(P) = SSZ(J):SSZ(J) = VI: RETURN

```

Run 2

NUMBER TO BE SORTED: 20	SSZ(I)	V\$(SSZ(I))	W\$(SSZ(I))
1	1	4	404253628
2	2	1	402547722
3	3	5	434901450
4	4	8	479759823
5	5	8	486269585
6	6	7	414017862
7	7	2	419927548
8	8	4	444603652
9	9	8	409932506
10	10	1	443768300
11	11	9	499438847
12	12	8	482977184
13	13	9	435976469
14	14	7	483034670
15	15	8	407571009
16	16	4	476527172
17	17	8	455937055
18	18	6	421968942
19	19	8	449919376
20	20	0	491381959

TOP=	P=	Q=	SK(ST)
4	9	9	
2	11	20	
2	21	20	
2	11	19	
2	19	19	
2	11	17	
2	11	12	
4	11	10	
4	12	12	
2	14	17	
2	14	13	
2	15	17	
2	18	17	
2	15	16	
2	15	14	
2	16	16	
0	0	0	
1	20	0	491381959
2	2	1	402547722
3	10	1	443768300
4	7	2	419927548
5	1	4	404253628
6	8	4	444603652
7	16	4	476527172
8	3	5	434901450
9	18	6	421968942
10	6	7	414017862
11	14	7	483034670
12	15	8	407571009
13	9	8	409932506
14	19	8	449919376
15	17	8	455937055
16	4	8	479759823
17	12	8	482977184
18	5	8	486269585
19	13	9	435976469
20	11	9	499438847

Need a solution for Floppy Disk or R/W Head problems?

FDL

Floppy Disk Lube

Just THREE drops can:

- Prolong useful disk life.
- Increase head life.
- Allow initialization of "problem" disks.
- Save 'unbootable' disks.
- Reduce 'glitching' problems.
- Cut nuisance problems.

FLOPPY DISK LUBE - 1/2 oz. WITH APPLICATOR. **\$4.00**

Add \$1.50 shipping and handling. Ohio residents add 5 1/2% sales tax.

DOSWARE, INC.
P.O. Box 10113
Cleveland, Ohio 44110

GRAFPAK

© 1981

HI-RES GRAPHICS DUMP ROUTINES

Low cost, easy to use, reproduction of both HiRes graphic pages in multiple scale factors with normal or inverse inking and variable image indentation.

Available now for Epson MX-70, graphic MX-80; Anadex DP-9xxx; and Integral Data 440/445/460/560. Other versions coming soon.

SmartWare
2281 Cobble Stone Court
Dayton, Ohio 45431

Dealer Inquiries Invited!



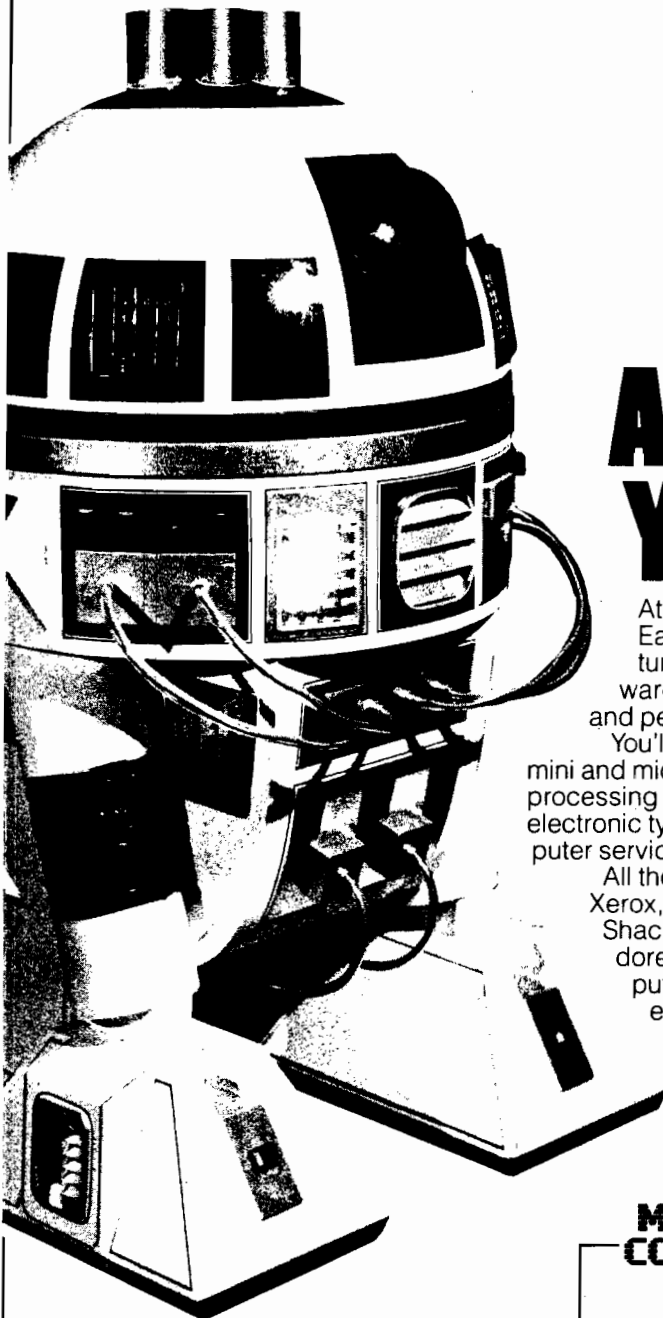

THE NATIONAL COMPUTER SHOWS

HAVE WE GOT A PROGRAM FOR YOU IN '81 & '82

Attend the biggest public computer shows in the country. Each show has 100,000 square feet of display space featuring over 50 Million Dollars worth of software and hardware for business, industry, government, education, home and personal use.

You'll see computers costing \$150 to \$250,000 including mini and micro computers, software, graphics, data and word processing equipment, telecommunications, office machines, electronic typewriters, peripheral equipment, supplies and computer services.

All the major names are there including; IBM, Wang, DEC, Xerox, Burroughs, Data General, Qantel, Nixdorf, NEC, Radio Shack, Heathkit, Apple, RCA, Vector Graphic, and Commodore Pet. Plus, computerized video games, robots, computer art, electronic gadgetry, and computer music to entertain, enthrall and educate kids, spouses and people who don't know a program from a memory disk.

Don't miss the Coming Of The New Computers - Show Up For The Show that mixes business with pleasure. Admission is \$5 for adults and \$2 for children under 12 when accompanied by an adult.

Ticket Information

Send \$5 per person with the name of the show you will attend to National Computer Shows, 824 Boylston Street, Chestnut Hill, Mass. 02167. Tel. 617 739 2000. Tickets can also be purchased at the show.

THE MID-WEST COMPUTER SHOW

CHICAGO
McCormick Place
SCHOESSLING HALL
23rd & THE LAKE

THURS-SUN
SEPT 10-13, 1981

11AM TO 7PM WEEKDAYS
11AM TO 6PM WEEKENDS

THE MID-ATLANTIC COMPUTER SHOW

WASHINGTON, DC
DC Armory/Starplex
2001 E. CAPITAL ST. SE
(E CAP. ST. EXIT OFF I 295
-KENILWORTH FRWY)
ACROSS FROM RFK
STADIUM

THURS-SUN
SEPT 24-27, 1981

11AM TO 7PM WEEKDAYS
11AM TO 6PM WEEKENDS

THE NORTHEAST COMPUTER SHOW

BOSTON
Hynes Auditorium
PRUDENTIAL CENTER

THURS-SUN
OCT 15-18, 1981

11AM TO 7PM WEEKDAYS
11AM TO 6PM WEEKENDS

THE SOUTHEAST COMPUTER SHOW

ATLANTA
Atlanta Civic Center
395 PIEDMONT AVE NE AT
RALPH MCGILL BLVD

THURS-SUN
OCT 29-NOV 1, 1981

11AM TO 7PM WEEKDAYS
11AM TO 6PM WEEKENDS

THE SOUTHERN CALIFORNIA COMPUTER SHOW

LOS ANGELES
LA Convention Center
1201 SOUTH FIGUEROA

THURS-SUN
MAY 6-9, 1982

11AM TO 7PM WEEKDAYS
11AM TO 6PM WEEKENDS

On Buying a Printer

By Loren Wright

You've decided to buy a printer and are either impressed or overwhelmed with the number of choices available. To help you decide which printer best suits your needs, we'd like to familiarize you with printer features and manufacturers.

In researching this article, we tried to get information from every manufacturer of microcomputer-compatible printers selling for \$2000 or less. The response was not 100%. Some manufacturers had moved, others had discontinued inexpensive models, others were out of business, and some simply failed to respond. Nevertheless, we compiled a substantial sample and will explain the many features printers offer. For more information see your local computer dealer or write the manufacturers. A list of addresses accompanies this article.

Probably the most important considerations are: "How much does it cost?" and, "Will it work with your computer?" However, there are many other features to consider. First, you should analyze your needs, both present and future. For instance, if you expect to be doing a lot of word processing, the quality of print would be an important feature. But if you expect to print large amounts of experimental data, then speed would be very important.

Characters

Most printers offer 96-character US ASCII character sets, which include both upper and lower case alphabets. Some of the less expensive printers print only upper case letters, however. This may be adequate for program listings and data printouts. Some printers allow substitution of the character ROM (Anadex, Base 2, Axiom IMP), and others allow at least one programmable character (Centronics 737 and 739, Base 2, C. Itoh Pro-Writer).

Print Quality

The best print quality is achieved with a formed character printer of the daisy wheel or ball (IBM) type. Most are priced well above our \$2000 limit, but some of the less expensive ones are sold by C. Itoh, Vista, and NEC.

All others are dot matrix printers. The smallest matrix used is 5 x 7. The print head consists of a vertical row of seven printing needles which are controlled by seven solenoids. These solenoids lift and raise the needles at the appropriate moments as the head moves across the line. Because these characters usually appear grayish, rather than black, they are difficult to read — especially in photocopies or when reduced for publication. Lower case letters with descenders (the part of the character that normally extends below the line, as with g, j, p, q, and y) are crowded above the line. When extra needles are added (9 is a common total) these true descenders can be produced, and often an underline can be added. Centronics 737 and 739, Anadex DP-9610 RO, and Epson MX-80 are models with extra needles.

Another way of improving print quality is to stagger the needles in two rows. The Integral Data Systems Paper Tiger uses five needles interwoven with four. Other, considerably more expensive printers, use as many as 18, thereby largely eliminating the blank spaces between the needle imprints that cause the gray appearance mentioned above.

Yet another method is adopted by the Epson MX-80; in the *double print* mode, the characters are first printed normally, then the paper is advanced 1/216" and those characters are printed again. This fills in most of the space created between dots on the first pass. The MX-80 also has a *print enhancement* mode where the needles actually hit the ribbon harder. This mode is particularly useful for making multiple copies. Either of these special modes

cuts the print speed in half and doubles the wear on the print head. Therefore these modes should be used judiciously.

Graphics Capability

Some printers allow individual control of every dot (Victor 5080, Base 2, Axiom, Centronics 739). This is useful in producing printouts of Apple Hi-Res screens. Even computers without high-resolution graphics can program these printers to produce high-resolution images. Base 2 offers an interface for Apple Hi-Res graphics. In this issue (39:44) a program is presented to dump the Apple Hi-Res screen to an Integral Data Systems Paper Tiger.

Line and Character Spacing

Some of the less expensive printers have a fixed number of characters per line, such as 21, 32, 40, 48, or 80. Be sure to get a line length that will suit your needs. Most other printers have line lengths variable from 40 to 132, selectable with either a program or switches.

Some printers (notably the Centronics 737 and 739) have a proportional spacing mode which produces copy like our typesetter prints this line. The narrower characters, such as 'I' and 'J,' take up less space than 'M' and 'W.' The overall effect is more pleasing than the 'monospace' copy produced by other printers.

With right-justification (also on the Centronics 737 and 739), the words line up at the right margin. Other printers produce what is called 'ragged right,' where alignment is achieved only at the left side of the page.

Variable line separation, subscripts, superscripts, and elongated characters are other extras to look for.

Paper Handling

Printer paper comes in a variety of forms and it is important to know which types your printer will take.

Fan fold is a continuous length of paper with holes on each edge. Usually the edges can be torn off and individual sheets separated. A wide variety of sizes and styles is available.

Roll is an inexpensive, long, continuous roll of paper. *Individual sheets* include stationery, letterhead, notebook paper, scrap paper, and special forms. Other papers available include *self-adhesive labels* and *multi-part forms*.

The most common method for advancing paper through a printer is with an adjustable tractor feed. Centronics and Epson models have a 'pin feed.' Both feed methods assure that paper can move quickly and precisely through the printer.

Self-adhesive labels and forms can be accommodated by tractor and pin feeds, but many of these feed mechanisms cannot handle the extra thickness and weight. Printer manufacturers usually specify the maximum thickness or number of plies that can be accommodated.

Individual sheets are handled by a friction feed mechanism (like a typewriter). These mechanisms will also handle roll paper, but a horizontal spindle of some sort for the roll is required.

Many printer models offer a combination of tractor and friction feeds.

Special Papers

Some of the less expensive printers require special paper. Thermal printers need special heat-sensitive paper. Instead of needles, the print head is composed of miniature heating elements which cause the paper to change color. Two cautions when using this paper are in order: 1) The blue-purple color commonly available does not photocopy well, and 2) the image tends to fade, particularly if transparent tape is applied over it.

The other kind of paper is electro-sensitive. The standard needles are replaced with electrodes, which complete an electrical circuit when applied to the aluminum-coated paper. The normally shiny surface is turned black to form a character image. Handling this paper can be a very messy undertaking, as the metal coating rubs off easily.

Both of these special papers are considerably more expensive than the plain paper, and not as easily available.

The advantage of these kinds of papers is in the cost of the printer. No ribbon, or the associated feed

mechanism, is required, nor are the seven or more individual solenoids to control the printing needles. Other economies such as fixed paper width, line length, and upper case only, are available to produce a truly bargain printer. At some point, however, the difference in the cost of the paper will add up to the difference in printer prices. This may take a few months, or many years, depending on how much you use your printer. Another advantage is that these printers tend to be quieter because they have fewer moving parts.

If you do decide to buy one of these non-impact printers, a useful feature is adjustable print darkness. A higher setting will make the copy more readable, while a lower one will extend the life of the print head. Also, as these print heads get older, the copy they produce gets lighter, so you will want to compensate for this aging.

Speed

The speed of a printer may be specified in characters per second (cps) or lines per minute. Formed character printers will typically do 25 to 50 cps, while dot-matrix printers are usually much faster. Typical values are 50 to 100 cps, while some print at 30 cps and others print faster than 200 cps. Sometimes there is a difference between the maximum or "burst" rate of printing and the average rate.

A number of printer features contributes to the overall speed. Bidirectional printing saves the time consumed by the extra carriage return required in unidirectional printing.

Logic seeking means the printer is able to look ahead and scout out the most efficient path for the print head. Both bidirectional printing and logic seeking require a buffer — an area of memory in the printer where it can inspect things before actually printing. Even without bidirectional printing or logic seeking, a buffer can add speed to the printing process. Until the buffer fills up, the printer will accept characters as fast as the computer sends them. Often, the computer is freed for other duty while the printer is still busy.

The use of special features, such as proportional spacing, right-justification, and print formatting may slow the printer down.

Several printers allow selection of the baud rate, either with switches or under program control.

Programmable Features

Some models allow extensive programming of printer operations. We have already mentioned programmable characters, elongated characters, baud rates, and line lengths. Other programmable features may include margins top-of-form, tabs, and print formatting (like print using).

Interfaces

Some printer models are sold as "designed for" a particular computer. There are a number available for the Apple, several for the TRS-80, and a few for the PET. Most, however, come with either a standard parallel, or RS-232C serial interface, or both. Special interfaces for particular machines usually cost extra. Most microcomputers however, will work with one of these standard interfaces.

The most common parallel interface is called "Centronics-compatible," which consists of seven data bits and three handshake bits. There are, however, 8-bit interfaces, and others which do not conform to the Centronics standard. Some additional circuitry or programming may be required if there is not complete interface compatibility.

Other interfaces are 20 mA current loop (or TTY) and IEEE-488. The 20 mA current loop is used with the AIM, SYM KIM, and other teletype-oriented machines. Adapting an RS-232C interface to 20 mA current loop is fairly easy requiring only a few components. IEEE-488 is generally used with the PET, but it is also used with Hewlett Packard and Tektronix controllers, and a wide variety of scientific test equipment.

Two manufacturers (Base 2 and Victor Data Systems) include all four of the above interfaces as standard in their printer models. Even the combination of a parallel and an RS-232C interface will increase the flexibility of your printer making it easier to use with computer other than your own.

Other Features

With *self test*, the printer goes through a series of procedures testing some or all of the printer's functions. This may be done on power-up or on demand.

An *out-of-paper signal* lets the printer detect when paper has run out, stops printing, and usually sounds an audio alarm.

A Different Approach

The Axiom/Seikosha GP-80M does not use the standard needle/solenoid design for impact dot matrix printers. Instead, it uses a unihammer (single hammer) which rapidly strikes against splines on a freely rotating platen behind the paper. This model is one of the least expensive printers that do not require special thermal or electrosensitive paper. At 30 cps it is also one of the slowest.

Build Your Own

Heath and Coosol sell *printer kits*. The advantages of building a kit are: 1) you save money, 2) you know how well it was put together, 3) you get extensive documentation so you can usually fix it yourself if something goes wrong. The disadvantages are: 1) you may do a poor job of building it, 2) it takes time you may not have.

Generally, prices are going down while capabilities increase. Most of the major computer manufacturers offer one or more printers as parts of their "systems." Often you pay a premium price for relatively little power. You do know these printers will work with the

specified computer, however, while it may take some effort to get a non-system printer working.

Whether you choose to buy the 'system' printer or opt for another, you certainly won't be saying, "I had no choice!"

Anadex, Inc.
9825 De Soto Avenue
Chatsworth, California 91311

Axiom Corporation
1014 Griswold Avenue
San Fernando, California 91340

Base 2
P.O. Box 3548
Fullerton, California 92634

Centronics Data Computer Corp.
Hudson, New Hampshire

Computer Devices, Inc.
25 North Avenue
Burlington, Massachusetts 01803
Mini Term 1201

Coosol, Inc.
P.O. Box 743
Anaheim, California 92805

Epson America, Inc.
23844 Hawthorne Boulevard
Torrance, California 90505

Heath Company
Benton Harbor, Michigan 49022

Integral Data Systems
Milford, New Hampshire 03055
Paper Tiger

C. Itoh Electronics, Inc.
5301 Beethoven Street
Los Angeles, California 90066

Microtek, Inc.
9514 Chesapeake Drive
San Diego, California 92123
Bytewriter-1

NEC Information Systems, Inc.
5 Militia Drive
Lexington, Massachusetts 02173

United Systems Corporation
918 Woodley Road
P.O. Box 458
Dayton, Ohio 45401
DigiTec 6430/6470 Non-impact

Victor Business Products
3900 North Rockwell Street
Chicago, Illinois 60618

Vista
1317 E. Edinger Avenue
Santa Ana, California 92705



AIM-65/SYM-PET-KIM-6800

Universal Interface Board Converts AIM-65/SYM
Into Professional Data Logger

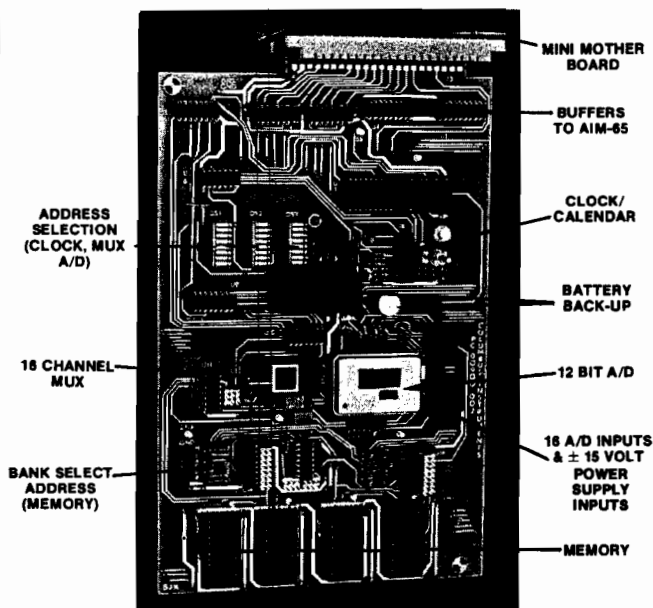

(Also connects to PET or KIM with adapter cable. Adaptable to other 6502 and 6800 systems)

CONTAINS:

- ★ 12 bits, 16 channels, fast A/D converter
- ★ space for additional 16K RAM memory or 32K EPROM (or combination)
- ★ real time clock/calendar with real time interrupt capability and 10-year lithium battery backup
- ★ plugs directly into AIM-65 expansion connector with the help of a mini-mother board which supports up to three interface boards
- ★ supplied with supportive demonstration and control programs

AVAILABLE MODELS:

- ★ IB-902 Additional Memory Space (only) \$ 390.00
- ★ IB-902-A Calendar/Clock plus memory space \$ 690.00
- ★ IB-902-B A/D (12 bits, 16 channels plus memory space) \$ 960.00
- ★ IB-902-AB A/D, plus memory space and calendar/clock \$1,270.00
- Mini mother board to support up to three (3) interface boards \$65.00

Quantity Discounts Available



COLUMBUS INSTRUMENTS INTERNATIONAL CORPORATION
Supplier of individual instruments and total measuring systems

950 N. HAGUE AVE., COLUMBUS, OHIO 43204 U.S.A.
PHONE: (614) 488-6178 TELEX: 246514

Using a TTY Printer with the AIM 65

While Rockwell provided both the hardware and software to permit TTY I/O on the AIM 65, output to a TTY while retaining AIM keyboard input is not allowed. The programs presented in this article provide for output to a teletype printer without restricting use of the AIM keyboard for input.

Larry P. Gonzalez
 Dept. of Physiology and Biophysics
 University of Illinois Medical Center
 P.O. Box 6998
 Chicago, Illinois 60680

I recently obtained a TTY printer for use with my AIM 65 microcomputer. Since the AIM contains a hardware TTY interface, and TTY I/O routines are provided in the monitor, I expected little difficulty getting my TTY printer up and running. While the hardware interface posed no problem, a closer look at the monitor I/O routines revealed that TTY output is allowed only when the TTY/KB switch is in the TTY position. This is because the monitor routine OUTPUT (\$E97A) tests the TTY/KB switch, instead of checking OUTFLG (\$A413) before sending a character to the TTY, or to the on-board Display/Printer. Thus, entering "L" to indicate TTY output only works with this switch in the TTY position. Since I want to retain use of the AIM keyboard while sending output to my TTY printer, the TTY/KB switch must be in the KB position. This prevents my use of the OUTPUT routine (called by OUTALL at \$E9BC).

Listing 1

```

;*
;* OUTPUT HANDLER FOR TTY PRINTER
;*
;* BY LARRY P. GONZALEZ
;*
;NOTE: LOAD PROGRAM START ADDRESS INTO UOUT ($10A)
; BEFORE CALLING THIS ROUTINE. FOR THIS
; ASSEMBLY, SET $10A=$00 AND $10B=$02
;
OUITTY EQU $EEA8 ;OUTPUT CHARACTER TO TTY
;
; ORG $200
;
;
; BCS SECND ;TEST FOR FIRST ENTRY
O200 B00D
O202 ;
O202 A925 FIRSTM LDA #$25 ;SET TRANSMISSION SPEED
O204 8D17A4 STA $A417
O207 A900 LDA #$00
O209 8D18A4 STA $A418
O20C 4C1C02 JMP END
O20F ;
O20F ;ALL SUBSEQUENT ENTRIES MADE HERE
O20F ;
O20F ;NOTE: ACC PLACED ON STACK IN OUTALL
O20F ;
O20F 68 SECND PLA
O210 C90D CMP #$0D
O212 D005 BNE OUT
O214 ;
O214 20A8EE TCRLF JSR OUITTY ;CR AND LF TO TTY
O217 A90A LDA #$0A
O219 20A8EE OUT JSR OUITTY
O21C 60 END RTS
END
    
```

Listing 2

```

;*
;* OUTPUT HANDLER AND FORMATTER
;* FOR TTY PRINTER
;*
;* BY LARRY P. GONZALEZ
;*
;MONITOR ADDRESSES
;
COMIN EQU $E182 ;MONITOR ENTRY
PELS EQU $E7DC ;BACK UP CURSOR
RED2 EQU $E976 ;DISPLAY CHARACTER
OUTPUT EQU $E97A ;OUTPUT ONE CHAR TO D/P
CRCK EQU $EA24 ;CLEAR POINTERS AND OUTPUT PRINT BUFFER
OUITTY EQU $EEA8 ;OUTPUT ONE CHAR TO TTY
CUREAD EQU $FEB3 ;READ ONE CHAR FROM THE KEYBOARD
;
PRINTR EPZ $00 ;ADDRESS OF MSG TO PRINT
PRIPOS EQU $34F ;PRINT HEAD POSITION
PGCNT EQU $350 ;PAGE COUNT
LINCNT EQU $352 ;LINE COUNT
PAGING EQU $353 ;PAGE FLAG
PFLAG EQU $354 ;PRINT FLAG
    
```

(Continued)

A TTY Output Handler

Listing 2

```

0392          TITLE EQU $355          ;TITLE
0392 57414E          ORG $392
0395 542050          WANT ASC 'WANT PAGING (Y/N)?;'
0398 414749
039B 4E4720
039E 28592F
03A1 4E293F
03A4 3B
03A5 20454E          TITLES ASC ' ENTER PAGE TITLE:;'
03AB 544552
03AB 205041
03AE 474520
03B1 544954
03B4 4C453A
03B7 3B
03B8 504147          PAGES ASC 'PAGE ;'
03BB 45203B
0200          ORG $200
0200
0200 A90D          INIT LDA #START          ;INITIALIZE UOUT
0202 8DOA01          STA $10A
0205 A902          LDA /START
0207 8DOB01          STA $10B
020A 4CB2E1          JMP COMIN
020D B07A          START BCS SECND
020F A925          FIRSTIM LDA #$25          ;SET TRANSMISSION SPEED FOR TTY
0211 8D17A4          STA $A417
0214 A900          LDA #$00
0216 8D18A4          STA $A418
0219 2024EA          JSR CRCK
021C A203          LDX /WANT          ;WANT PAGING?
021E A092          LDY #WANT
0220 20FC02          JSR PRINT
0223 2083FE          JSR CUREAD
0226 8D5303          STA PAGIND
0229 C959          CMP 'Y'
022B D065          BNE TCRLF
022D 2024EA          JSR CRCK
0230 A901          LDA #$01          ;INITIALIZE PAGE COUNT AND LINE NUMBER
0232 8D5203          STA LINCNT
0235 8D5003          STA PGCNT
0238 A900          LDA #$00
023A 8D5103          STA PGCNT+1
023D A203          LDX /TITLES          ;GET PAGE TITLE
023F A0A5          LDY #TITLES
0241 20FC02          JSR PRINT
0244 2024EA          JSR CRCK
0247 A200          LDX #$00
0249 2083FE          TTLIN JSR CUREAD
024C C97F          CMP #$7F          ;DELETE?
024E D00B          BNE CHARIN
0250 E000          CPX #$00
0252 F0F5          BEQ TTLIN
0254 CA          DEX          ;BACK UP POINTER
0255 20DCE7          JSR PSL5          ;BACK UP DISPLAY
0258 4C4902          JMP TTLIN
025B C90D          CHARIN CMP #$0D
025D F00B          BEQ TTLEND
025F 2076E9          JSR RED2
0262 9D5503          STA TITLE,X
0265 E8          INX
0266 E030          CPX #$30          ;IS BUFFER FULL (60 CHARS)?
0268 D0DF          BNE TTLIN
026A A93B          TTLEND LDA #$3B          ;STORE ';' TO END TITLE
026C 9D5503          STA TITLE,X
026F          ;TITLE OUTPUT ROUTINE
026F 209202          TTLOUT JSR TCRLF
0272 209202          JSR TCRLF
0275 20EF02          JSR LINE
0278 A203          LDX /TITLE
027A A055          LDY #TITLE
027C 200003          JSR TPRINT
027F 20B302          JSR PGMUM
0282 A902          LDA #$02
0284 8D5203          STA LINCNT
0287 D009          BNE TCRLF
    
```

(Continued)

The program presented in listing 1 is a short user output handler which replaces the AIM OUTPUT subroutine to allow TTY output while retaining input from the AIM keyboard. This program tests the carry bit to determine if this is the first entry to this routine. The first entry usually occurs with execution of the monitor WHEREO (\$E871) subroutine, which clears the carry bit upon first entry to a user output handler. If the carry is clear (first entry), the baud rate (\$A417) and delay (\$A418) are initialized and an RTS (Return from Subroutine) is executed. I found that the parameters suggested by Rockwell (page 9-31 of the user's guide) did not work well with my printer; the values I used were determined by trial and error.

For subsequent entry, the carry bit should be set prior to jumping to this program, as is done by the monitor OUTALL routine. OUTALL places the character to be output onto the stack, so this character is pulled into the accumulator upon subroutine entry. If the character is a carriage return (\$0D), it is sent to the TTY and is followed by a linefeed (\$0A). Otherwise, the character is output to the TTY, using the monitor OUTTTY routine (\$EEA8), and an RTS instruction is executed.

Output is directed to the TTY printer by loading the start address of this program (here \$0200) into the vector to the user output handler (UOUT = \$010A, \$010B) and specifying "U" as the output device. This can be used with any of the AIM routines which permit a selection of the output device.

Providing Page Titles and Numbers

A fancier output handler is presented in listing 2. This program requires more memory, but is easier to use (it loads the start address into UOUT) and provides for optional page headings and page numbers.

To use this program, first run the program at \$0200 to enter the routine start address into UOUT. Output can then be directed to the TTY from the AIM monitor, from the Text Editor, or from the Assembler (but not from the AIM disassembler) by specifying "U" as the output device. The message "WANT PAGING (Y/N)?" will be displayed, to which a response of "N" will result in unformatted (no paging) output to the TTY. A response of "Y" is followed by the message "ENTER PAGE

TITLE:" The user can then enter a title of up to 60 characters, terminated by a carriage return, which will be output as a header on each page of output, along with the page number.

The program listings presented in this article were prepared on my TTY printer using this program.

Directing Disassembled Output to the TTY

As noted above, the programs in listings 1 and 2 may be used by the AIM monitor, the Text Editor, or the Assembler. The AIM disassembler, however, sends output to the AIM printer without an optional output device. Since I often save disassembled listings as part of my program documentation, I also wanted the capability of directing the output of the disassembler to my TTY printer. Listing 3 presents a program which provides this ability.

This program is very similar to the AIM disassembler, but it has OUTFLG set to "U" to permit TTY output, and has calls to the monitor routine CRCK (\$EA24) changed to CRLF (\$E9F0). Using CRLF allows sending carriage return characters to the TTY printer while retaining AIM keyboard input. Run this program (* = \$8D00) and respond to the prompts as for the AIM disassembler. Output is directed to the TTY printer.

With these programs my TTY printer is a useful addition to my AIM 65 system.

Larry P. Gonzales is an Assistant Professor of Physiology and Biophysics at the University of Illinois Medical Center. He has 12 years experience programming in high level languages and several years in the use of minicomputers for real-time data acquisition and signal analysis. During the last two years he has been developing a system using an AIM 65 in the collection and analysis of electrophysiological data.

MICRO

Listing 2

```

0289 ;SECOND & SUBSEQUENT ENTRY TO TTYOUT
0289 ;ACC WAS PUSHED IN OUTALL
0289 68 SECND PLA
028A C90D CMP #$0D
028C F004 BEQ TCRLF
028E 20AEE JSR OUTTTY
0291 60 RETRN RTS
0292 A90D TCRLF LDA #$0D ;CR AND LF TO TTY PRINTER
0294 20AEE JSR OUTTTY
0297 A90A LDA #$0A
0299 20AEE JSR OUTTTY
029C AD5303 LDA PAGING
029F C959 CMP 'Y
02A1 D00F BNE RTNR
02A3 A900 LDA #$00
02A5 8D4F03 STA PRTPOS
02A8 EE5203 INC LINCNT
02AB AD5203 LDA LINCNT
02AE C93F CMP #$3F
02B0 F0BD BEQ TTYOUT
02B2 60 RTNR RTS
02B3 ;OUTPUT PAGE NUMBER TO TTY PRINTER
02B3 AD4F03 PGNUM LDA PRTPOS
02B6 C93F CMP #$3F
02B8 F00A BEQ PGOUT
02BA A920 LDA #$20
02BC 20AEE JSR OUTTTY
02BF EE4F03 INC PRTPOS
02C2 10EF BPL PGNUM
02C4 A203 PGOUT LDX /PAGES
02C6 A0B8 LDY #PAGES
02C8 200003 JSR TPRINT
02CB AD5103 LDA PGCNT+1
02CE 203703 JSR TTYOUT
02D1 AD5003 LDA PGCNT
02D4 203703 JSR TTYOUT
02D7 209202 JSR TCRLF
02DA F8 SED ;UPDATE 2-BYTE DECIMAL PAGE COUNTER
02DB 18 CLC
02DC A901 LDA #$01
02DE 6D5003 ADC PGCNT
02E1 8D5003 STA PGCNT
02E4 D008 BNE CLEAR
02E6 A900 LDA #$00
02E8 6D5103 ADC PGCNT+1
02EB 8D5103 STA PGCNT+1
02EE D8 CLEAR CLD
02EF ;OUTPUT LINE TO TTY PRINTER
02EF A249 LINE LDX #$49
02F1 A92D LDA #$2D
02F3 20AEE PRMT JSR OUTTTY
02F6 CA DEX
02F7 D0FA BNE PRMT
02F9 4C9202 JMP TCRLF
02FC ;PRINT MSG OR TITLE TO DISP/PR OR TO TTY PRINTER
02FC A9FF PRINT LDA #$FF
02FE D002 BNE TPRINT
0300 A900 TPRINT LDA #$00
0302 8D5403 TPRINT2 STA PFLAG ;SAVE ZERO PAGE DATA
0305 A500 LDA PRTADR
0307 48 PHA
0308 A501 LDA PRTADR+1
030A 48 PHA
030B 8601 STX PRTADR+1
030D 8400 STY PRTADR
030F AE5403 LDX PFLAG
0312 A000 LDY #$00
0314 B100 PRINT3 LDA (PRTADR),Y
0316 C93B CMP ' ;DONE?
0318 D009 BNE CHRUT ;RESTORE ZERO PAGE DATA
031A 68 PLA
031B 8501 STA PRTADR+1
031D 68 PLA
031E 8500 STA PRTADR
0320 4C9102 JMP RETNR
0323 E000 CHRUT CPX #$00
0325 F006 BEQ TTY
0327 207AE9 JSR OUTPUT
032A 4C3003 JMP INCR
032D 20AEE TTY JSR OUTTTY
0330 C8 INCR INY
0331 EE4F03 INC PRTPOS
0334 4C1403 JMP PRINT3
    
```

(Continued)

Listing 2

```

0337          ;OUTPUT 2 HEX CHARACTERS TO TTY PRINTER
0337 48      THXOUT PHA
0338 4A          LSR
0339 4A          LSR
033A 4A          LSR
033B 4A          LSR
033C 204203     JSR CNVRT
033F 68          PLA
0340 290F          AND #$0F
0342 18      CNVRT CLC
0343 6930          ADC #$30
0345 C93A          CMP #$3A
0347 9002          BCC CHRPRT
0349 6906          ADC #$06
034B 20A8EE     CHRPRT JSR OUTTTY
034E 60          END RTS
                END
    
```

Listing 3

```

;* DISASSEMBLING TO TTY
;* BY LARRY P. GONZALEZ
;REPLACES CRCK IN AIM'S DISASSEMBLER WITH CRLF
COMIN EQU $E182          ;MONITOR ENTRY
CGPCO EQU $E5D7          ;ALTER PROGRAM COUNTER
GCNT EQU $E785          ;GET NUMBER OF LINES
DONE EQU $E790          ;CHECK COUNT
PSLL EQU $E837          ;PRINT '/'
RCHEK EQU $E907          ;CHECK FOR STOP COMMAND
OUTPUT EQU $E97A          ;OUTPUT TO TTY OR TO D/P
CRLF EQU $E9F0          ;OUTPUT CR AND LF
ADDIN EQU $EA8E          ;GET FOUR BYTE ADDRESS
OUTTTY EQU $EEA8          ;OUTPUT ONE CHARACTER TO TTY
DISASM EQU $F46C          ;DISASSEMBLE ONE INSTRUCTION

8D00 A95C          ORG $8D00          ;INITIALIZE JUMP TO USER OUTPUT HANDLER
8D02 8D0A01        LDA $UCOUT
8D05 A98D          STA $10A
8D07 8D0B01        LDA /UCOUT
8D0A A925          STA $10B
8D0C 8D17A4        LDA #$25          ;SET TRANSMISSION SPEED
8D0F A900          STA $A417
8D11 8D18A4        LDA #$00
8D14 AD13A4        STA $A418
8D17 48           LDA $A413          ;SAVE OUTFLG
8D18 A955          PEA
8D1A 8D13A4        LDA 'U'          ;SET OUTFLG="U"
8D1D A92A      KDISA LDA $S2A          ;GET START ADDRESS
8D1F 207AE9        JSR OUTPUT
8D22 20AEEA        JSR ADDIN
8D25 B0F6          BCS KDISA
8D27 20D7E5        JSR CGPCO
8D2A 2037E8        JSR PSLL
8D2D 2085E7        JSR GCNT          ;GET COUNT OF INSTRUCTIONS
8D30 20F0E9        JSR CRLF
8D33 4C3E8D        JMP JDB
8D36 2007E9        JDA JSR RCHEK
8D39 2090E7        JSR DONE          ;ARE WE DONE?
8D3C F017          BEQ JDD
8D3E 206CF4        JDB JSR DISASM          ;GO TO DISASSEMBLER
8D41 AD25A4        LDA $A425          ;UPDATE PROGRAM COUNTER
8D44 38           SEC
8D45 65EA          ADC $EA
8D47 8D25A4        STA $A425
8D4A 9003          BCC JDC
8D4C EE26A4        INC $A426
8D4F 20F0E9        JDC JSR CRLF
8D52 4C368D        JMP JDA
8D55 68           JDD PLA          ;RESTORE OUTFLG
8D56 8D13A4        STA $A413
8D59 4C82E1        JMP COMIN          ;RETURN TO MONITOR

8D5C          ;TTY OUTPUT HANDLER
8D5C 68      UOUT PLA
8D5D C90D          CMP #$0D
8D5F D005          BNE OUT
8D61 20A8EE        TCRLF JSR OUTTTY
8D64 A90A          LDA #$0A
8D66 20A8EE        OUT JSR OUTTTY
8D69 60          END RTS
    
```

THE FASTEST, MOST POWERFUL HIGH-LEVEL LANGUAGE SYSTEM FOR THE APPLE

Developed from an extended version of FORTH, microSPEED combines the benefits of compiled code and hardware arithmetic processing for maximum microcomputing performance

COMPLETE SYSTEM \$495.00
USER'S MANUAL ONLY 35.00

INFORMATION HOT LINE (301) 627-6650

applied analytics incorporated

8910 Brookridge Dr., Upper Marlboro, Md. 20870

- * Runs six to sixty times faster than Basic
- * Programming capabilities well beyond Applesoft
- * Auxiliary Processor [AM9511] for fast Floating Point
- * High-speed, extended high resolution graphics
- * Software development time cut in half
- * Exceptionally compact, compiled code
- * Extensible, structured language to meet your needs
- * Requires 48K Apple II or II+, single Disk

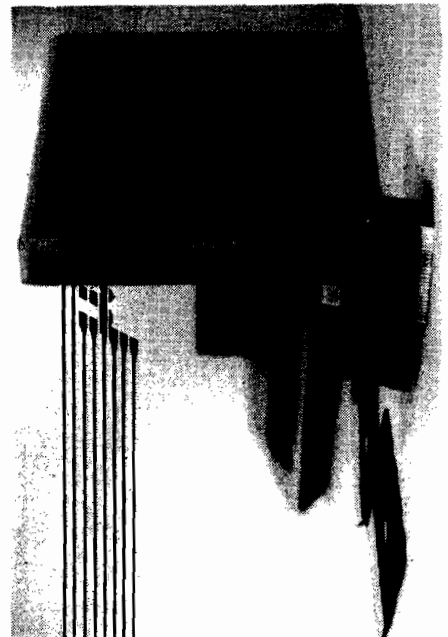

A \$200 Printer for C1P & Superboard

Hardware modifications are presented to interface the C1P to a Radio Shack Quick Printer II. Software considerations are discussed and demonstration programs are included.

Louis A. Beer
P.O. Box 705
Portola, California 96122

If you write programs, a near must for your computer is a printer. The Radio Shack Quick Printer II is relatively fast (32-character 120 lines per minute), reliable, quiet, and inexpensive (approximately \$200). It is easy to interface to the Ohio Scientific C1P or Superboard. This article explains how.

There are three problems to handle, and all are quite easily overcome:

1. The Quick Printer operates at 600 baud. The C1P normally operates at 300 baud.
2. The Quick Printer sends a +5 volt signal on the CTS (clear-to-send) line to indicate it is ready to receive data, and -6.2 volts to indicate not ready. The C1P serial interface (ACIA, U-24 on the OSI schematic) takes +5 volts on its CTS line to inhibit sending data, and ground potential on this line to enable sending data.
3. The C1P character output program in ROM outputs ten nulls at the beginning of each print line. The Quick Printer does not recognize nulls (\$00), and therefore locks up and sends a 'not clear-to-send' signal when these are encountered. Some previous fixes for solving this problem have merely eliminated the nulls, but this makes reliable saving on tape impossible once the fix is in memory. The loss of the ten nulls at the beginning of each line causes reading errors when reading the tape back. My system eliminates this problem by substituting the ASCII 'SOH' (start of

heading) for the nulls. The Quick Printer recognizes this character, discards it, and waits for a printable character. The C1P treats it as a null.

Let's take these problems in order and give the solutions. First, to make the C1P switchable for 300 or 600 baud, locate pin 2 of U57 and cut the trace (which goes to pin 14 of U59) so that it can be switched to either pin 14 of U59 for normal 300 baud operation, or pin 11 of U30 for 600 baud operation. One half of a double-pole double-throw switch is used. (See wiring diagram.)

Second, to make the CTS (clear-to-send) switchable between normal C1P operation and Quick Printer operation, again refer to wiring diagram. Cut the trace at W3 (on the C1P) from pin 24 of U24 (ACIA) to ground. Use the other half of the double-pole double-throw switch to switch the CTS line (pin 24) between ground (normal, 300 baud, printer-off) and emitter of an audio transistor, which will effectively provide ground for 'clear-to-send' and +5 volts for 'not clear-to-send' signals being received from the printer.

Figure 1: C1P Modifications to Operate Quick Printer II

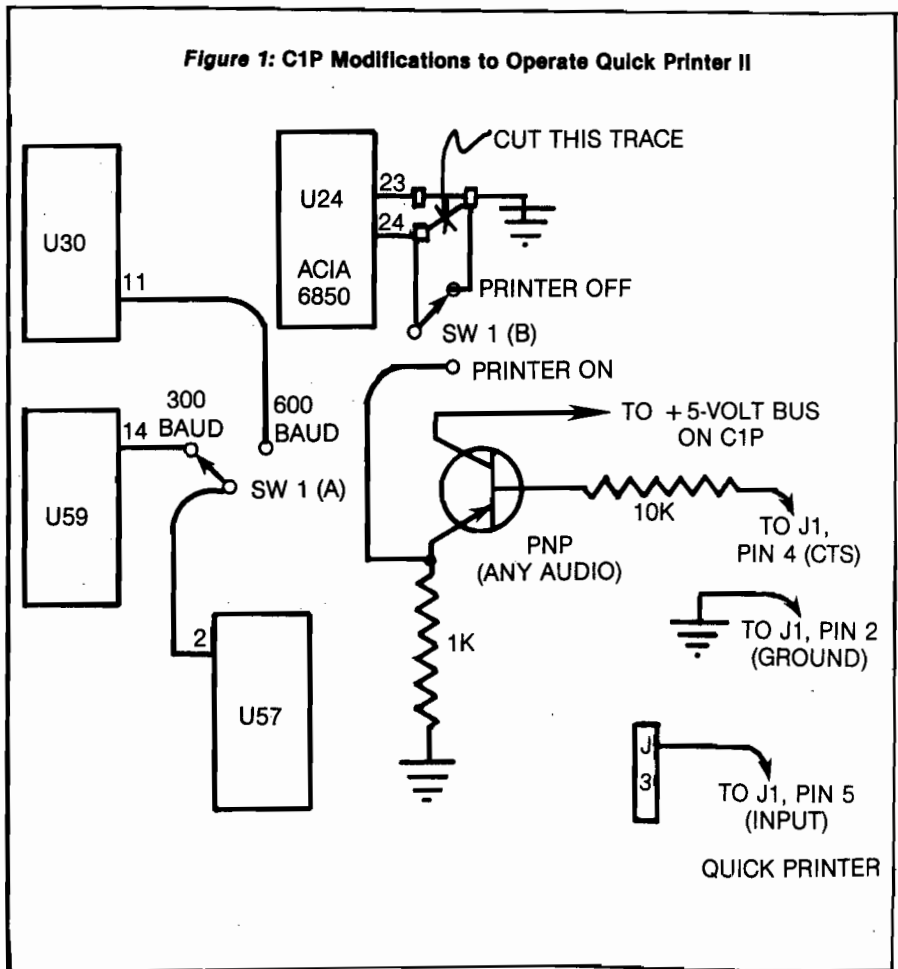

I soldered the transistor collector directly to the +5-volt bus on the C1P, and the emitter through the 1K ohm ¼-watt resistor to the ground bus so that it is mechanically self-supporting. Any 3-wire connector can be used to connect the cable from the Quick Printer. I used a couple of RCA jacks. The RS-232 (out) port on the C1P must be populated per the diagram in the user's manual if you have not already done so. This takes four resistors and one PNP transistor and is rather easy to do. The schematic is in the user's manual and labelled "sheet 6 of 13." Only R72, R63, R64, R65 and Q1 are required. Any PNP audio transistor will do for Q1.

Third, the 8-line program given here will take care of the null problem. The BASIC support for outputting characters is in ROM \$FF69 to \$FF95 (65385 to 65429 dec). What we will do is lift this entire routine and put it in unused RAM, then replace the null at \$FF80 with the SOH (\$10). We do this by reading these 44 bytes and POKEing them into unused RAM starting at \$0222 (546 dec). This is all done by lines 2 and 8. Lines 3, 4, 6 and 7 set the output vector and warm start pointers so that any output will use the routine starting at \$0222 rather than the one in

ROM \$FF69. To set up your machine, LOAD this program, then RUN. It takes about a second to run. Next, hit BREAK and W (warm start) and you are in business.

You should next clear this BASIC program by typing NEW and hitting RETURN, or (in case you have another BASIC program already in memory and don't want to lose it) by typing 1 through 8 with RETURN to eliminate each line. The reason for clearing the program is that the DATA statements can confuse another program using DATA statements. Warm start will continue to work, but after any cold start the program will have to be loaded and run again to use the printer.

Here is the general operating procedure: when you want to list a program in the computer on the printer, start with the switch you installed in the normal (300 baud, no print) position. Type SAVE, hit RETURN, type LIST (and line numbers to be listed, if desired). Now turn on the printer mainline switch and put its PRINT switch to the on-line (up) position. The printer INPUT SELECT switch should *always* be in SERIAL (down) position. The printer will now print "PRINTER READY." Now put the

double-pole switch you installed in the 600 baud/print position. Hit RETURN, and out comes your program listing. You can have the printer "on-line" when running a program which has printed output (a disassembler, for example) but watch out for excessive use of paper by PRINT statements used for screen clearing, etc.

1 REM:QUICK PRINTER FIX BY LOU BEER

2 M = 546:FORN = 65385TO 65429:P = PEEK(N):POKEM,P :M = M + 1:NEXTN

3 DATA169,34,141,26,2,169,2, 141,27,2,76,116,162

4 DATA76,216,0

6 FORN = 216TO228:READP: POKEN,P:NEXTN

7 FORN = 0TO2:READP:POKEN, P:NEXTN

8 POKE569,16:END

OK

The whole modification is simpler than it sounds. If you have any problems in getting it to work, I will be glad to assist if you send a S.A.S.E.

MICRO

- Z-FORTH IN ROM by Tom Zimmer
5 to 10 times faster than Basic. Once you use it, you'll never go back to BASIC!
source listing add \$ 75.00
\$ 20.00
 - OSI FIG-FORTH True fig FORTH model for OS65D with fig editor named files, string package & much more \$ 45.00
 - TINY PASCAL Operates in fig-FORTH, an exceptional value when purchased with forth. TINY PASCAL & documentation \$ 45.00
\$ 65.00
 - SPACE INVADERS 100% machine code for all systems with 64 chr. video. Full color & sound on C2, 4P & 8P systems. The fastest arcade program available. \$ 14.95
 - PROGRAMMABLE CHARACTER GENERATOR \$ 99.95
Use OSI's graphics or make a complete set of your own! Easy to use, comes assembled & tested. 2 Mhz. boards \$109.95
 - PROGRAMMABLE SOUND BOARD \$ 74.95
\$29.95
Complete sound system featuring the AY-3-8910 sound chip. Bare boards available. \$ 39.95
 - 32/64 CHARACTER VIDEO MODIFICATION \$ 39.95
Oldest and most popular video mod. True 32 chr. C1P, or 32/64 chr. C4P video display. Also adds many other options.
 - ROMS!!!
Augment Video Mod with our Roms. Full screen editing, print at selectable scroll, disk support and many more features. Basic 4 & Monitor \$ 49.95
\$ 18.95
\$ 65.00
Basic 3
All 3 for
 - 65D DISASSEMBLY MANUAL. by Software Consultants. First Class throughout. \$ 24.95
A must for any 65D user.
- NUMEROUS BASIC PROGRAMS, UTILITY PROGRAMS AND GAMES ALONG WITH HARDWARE PROJECTS. ALL PRICES ARE U S FUNDS. Send for our \$1.50 catalogue with free program (hardcopy) Memory Map and Auto Load Routine.

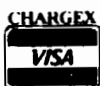

OSI Software & Hardware
3336 Avondale Court
Windsor, Ontario, Canada N9E 1X6
(519) 969-2500
3281 Countryside Circle
Pontiac Township, Michigan 48057
(313) 373-0468



progressive computing

C1P to Epson MX-80 Printer Interface

A circuit is presented to interface the C1P to the popular Epson MX-80 printer.

Gary E. Wolf
227 Grove Street
Clifton, New Jersey 07013

There have been several articles written on interfacing the C1P with a printer, but it seems that each printer needs its own instructions. The Epson MX-80 is no exception.

Other sources have detailed the installation of the RS-232C, and figure 1 shows the schematic. By cutting the W10 trace, a negative 9 VDC can be applied at this point, via J3 pin 7. I used a simple transistor radio battery eliminator for this. Important: remember correct polarity. Positive on this source is ground.

Next, cut the trace that connects the ACIA (U14) pin 24 to ground. (See figure 2.) Solder a jumper from pin 24 to the CTS trace. Then mount a SP2T (single pole double throw) switch somewhere on the computer enclosure to put ground back on pin 24 when you use a cassette. The cassette won't operate properly if this pin is floating.

I mounted a DB-25 connector in the rear of my cabinet. Since only three pins will be used, almost any connector will do. Solder the cross connections between the DB-25 and a Molex connector, which fits into J3 on your computer board. (See figure 4.) Now to the printer.

I assume you have bought the MX series option for your printer, since it will not interface to a C1P without one. If the board has been installed, you may

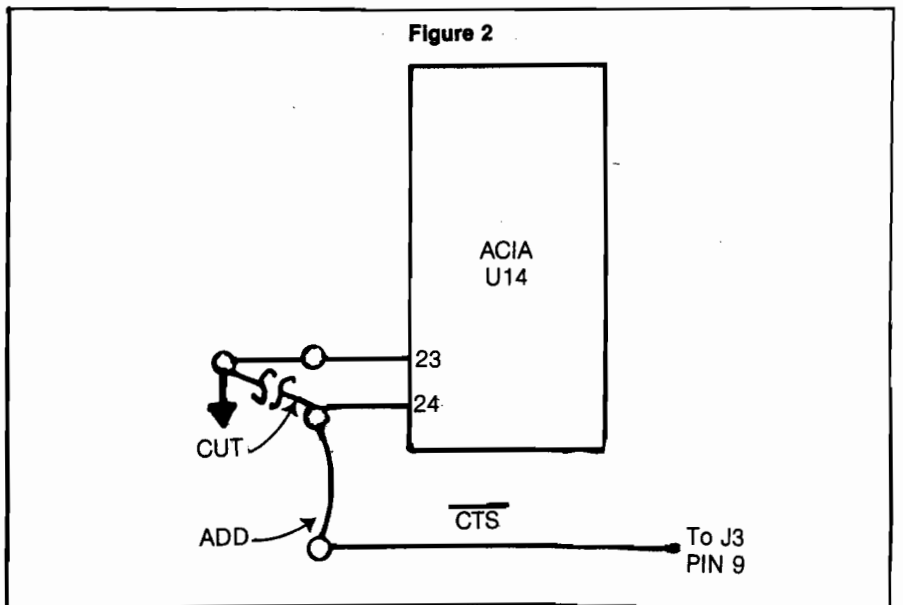
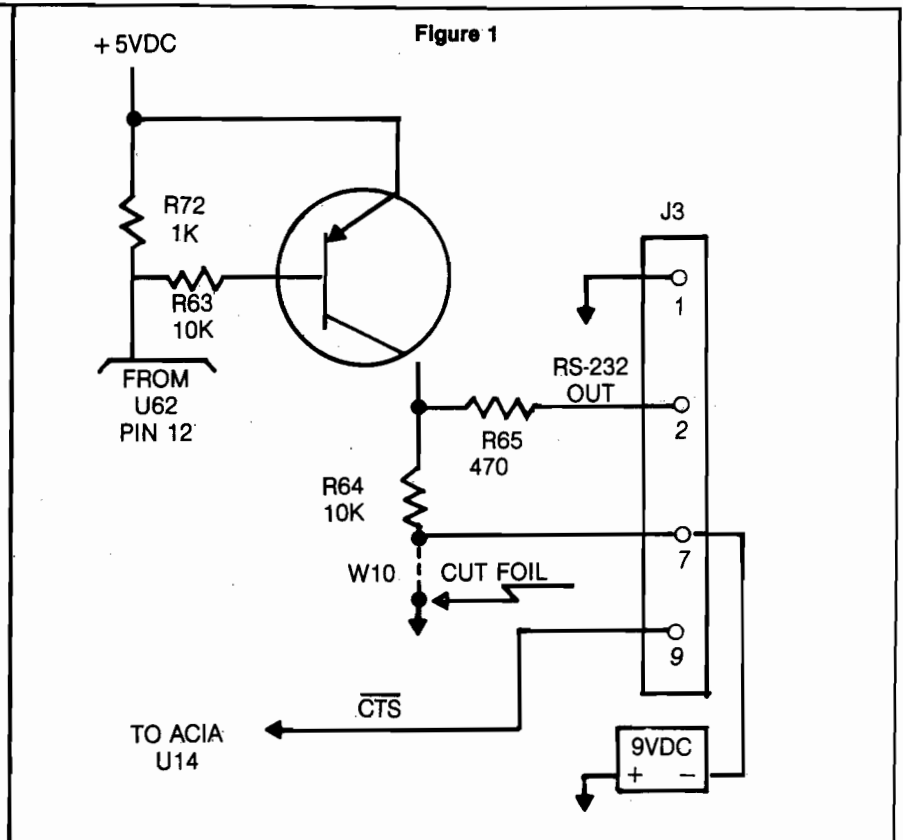

be ready to plug in the cable and be off and running, but don't count on it! Go to the series option manual and follow the instructions for removal of the printer cover. Check the settings on DIP switch 8141. See table 2 on page 4 of your manual. Settings should agree with table 1 (shown here).

Table 1: Setting of DIP SW (8141)

Pin	Setting for 300 B.P.S.
1	Off
2	Off
3	On
4	On
5	N/A
6	Off
7	Off
8	N/A

The board comes from the factory with jumper JNOR connected. It should be cut and jumper JREV should be installed. This adds another inverter to the output at pin 11.

Pin 11 ultimately connects to the CTS lead at your computer. This is the handshake. A high signal on CTS inhibits ACIA output. With JREV on and JNOR off the C1P will send out data only when the printer is ready for it. Note also that ground from the computer is connected to pin 7 of the printer, *not* pin 1. They are not the same.

I have included a simple address and label program to get you started. The Epson MX-80 is a great printer, and although there are a few spots in the manuals that are confusing, most of the information is clear and helpful. With these tips you should have no problem with the interface.

MICRO

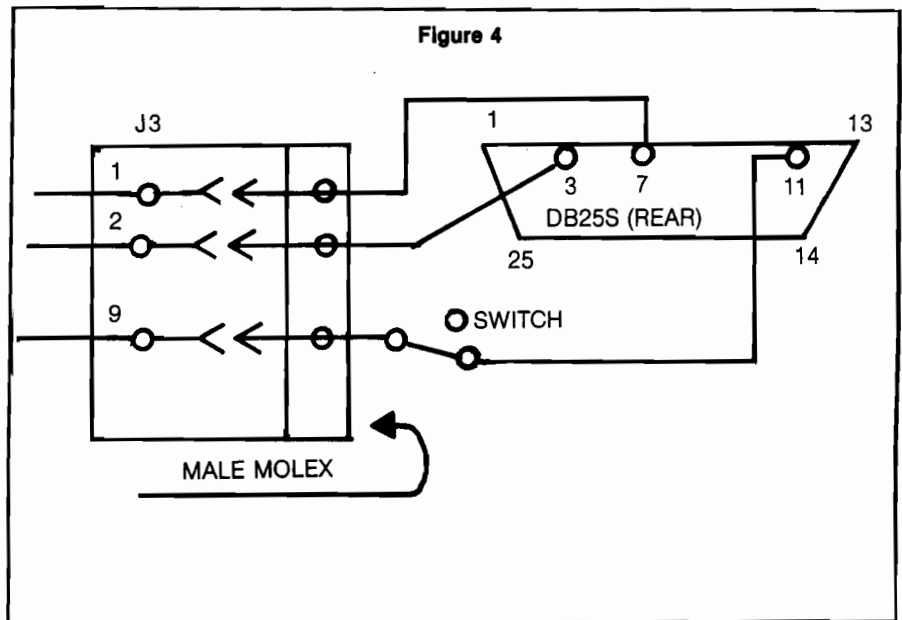
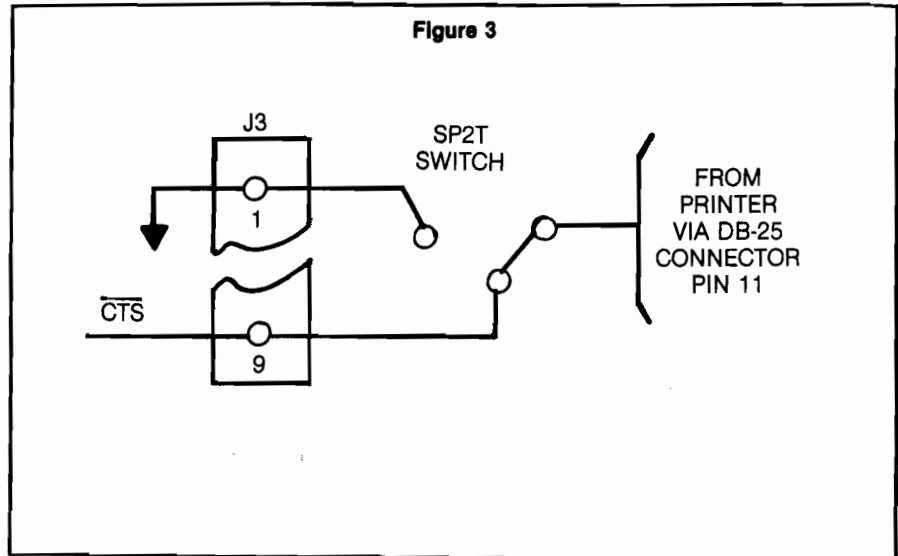

Send for FREE Control Page Also Available soon on Atari

EDIT 6502 T.M. LJK

Two Pass Assembler, Disassembler, and Editor Single Load Program
DOS 3.3., 40/80 Columns, for Apple II or Apple II Plus*

A MUST FOR THE MACHINE LANGUAGE PROGRAMMER. Edit 6502* is a two pass Assembler, Disassembler and text editor for the Apple computer. It is a single load program that only occupies 7K of memory. You can move freely between assembling and disassembling. Editing is both character and line orientated, the two pass disassemblies create editable source files. The program is so written so as to encompass combined disassemblies of 6502 Code, ASCII text, hex data and Sweet 16 code. Edit 6502 makes the user feel he has never left the environment of basic. It encompasses a large number of pseudo opcodes, allows linked assemblies, software stacking (single and multiple page) and complete control of printer (paganation and tab setting). User is free to move source, object and symbol table anywhere in memory. Requirements: 48K of RAM, and ONE DISK DRIVE. Optional use of 80 column M&R board, or lower case available with Paymar Lower Case Generator.

TAKE A LOOK AT JUST SOME OF THE EDITING COMMAND FEATURES. Insert at line # n Delete a character Insert a character Delete a line # n List line # n1, n2 to line # n3 Change line # n1 to n2 "string" Search line # n1 to n2 "string"

LOOK AT THESE KEY BOARD FUNCTIONS: Copy to the end of line and exit: Go to the beginning of the line: abort operation: delete a character: at cursor location: go to end of line: find character after cursor location: non destructive backspace: insert a character at cursor location: shift lock: shift release: forward copy: delete line number: prefix special print characters. Complete cursor control: home and clear, right, left down up. Scroll a line at a time. **Never type a line number again.**

All this and much much more — Send for FREE information.
Introductory Price \$50.00.

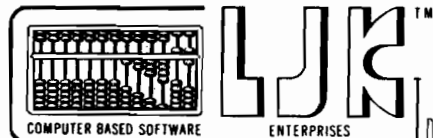

LJK Enterprises Inc. P.O. Box 10827 St. Louis, MO 63129 (314)848-8124
*Edit 6502 T.M. of LJK Ent. Inc. — *Apple T.M. of Apple Computer Inc.

Utilities for the Paper Tiger 460

Here are two utilities for the Paper Tiger 460 printer for use with the Apple II. The Applesoft BASIC program lets you set all the programmable features of the Paper Tiger by choosing from a menu. The machine language program dumps the Apple Hi-Res graphics screen buffer to the printer.

Terry L. Anderson
 Dept. of Physics & Computer Science
 Walla Walla College
 College Place, Washington 99324

The Paper Tiger 460 is an exciting addition to the group of printers available to the personal computer user. This dot matrix printer uses paper up to 10.5 inches wide and prints at a mode-dependent speed of up to 150 characters per second. It has a graphic option with 84 dots to the inch resolution (both vertical and horizontal). This is nearly double the resolution of most other printers with dot graphic modes. But the most unique feature is the use of overlapping dots. Most printers use a single row of print head wires allowing dots that nearly touch but cannot overlap. The 460 uses two side-by-side rows of four and five wires, respectively, which are staggered so that the resulting dots overlap about 30%. Thus a vertical line such as is used to print an 'L' or an 'I' is solid without distinct dots and has very little raggedness. The result is type quality nearly as good as fully-formed character printers such as Diablo and IBM Selectric, and adequate for many word processing applications.

The overlapping dots also allow solid black areas in graphics. With non-overlapping dot graphic printers, four dots in a square pattern leave a little white in the center of the pattern. This results in a slightly gray effect. But the overlapping dots of the 460 filling in the

center of a four-dot square pattern completely, result in very solid blacks. This is important if you want to use the printer to construct bar code patterns for use with readers such as the new HEDS-3000 bar code wand from Hewlett-Packard. Areas of white in the middle of a bar can result in false readings. The Paper Tiger 460 should be very useful as a bar code printer, which is one of my next projects.

The high resolution of the 460's printing allows more options than most dot matrix printers have. These options include six character sizes, variable vertical line spacing, fractional line spacing up and down for sub- and super-scripts, and fully right- and left-justified text using variable character spacing, not just extra spaces between words. The firmware allows all of these features to be used under program control. This results in a great deal of flexibility, such as mixing type sizes on one line, and sub- and super-scripts. But choosing a feature requires sending special control characters, even if one feature is to be used for an entire print job. Some of these are hard to remember and some are difficult to send from the Apple keyboards, which cannot generate all 128 ASCII characters. Several important functions on the 460 require characters not available on Apple's keyboard. The one that enables auto-justification (control-D) conflicts with Apple's DOS use of that character, so some can only be sent using a program.

Tiger Setup

To make configuring the Paper Tiger 460 easy we need a configuring program. The first program, TIGER SETUP,

allows you to choose the features you want from a menu. This reminds you which features are available and you don't have to remember all the special characters. When you exit with 'Q' (for quit) all the special characters to program the printer are sent.

The menu shows the options with the currently-selected value indicated by inverse video. Many selections are made with a single keystroke to toggle the state of the printer, such as between auto-justify mode and normal, or between six and eight lines per inch. The key is indicated by inverse video. Some selections require a single keystroke followed by a value for a parameter. The single keystroke will place the cursor just in front of the old value and allow a new value to be typed over the old. Choosing length of a form is an example. A few selections require two keystrokes; one to choose the category and the second a subcategory, such as

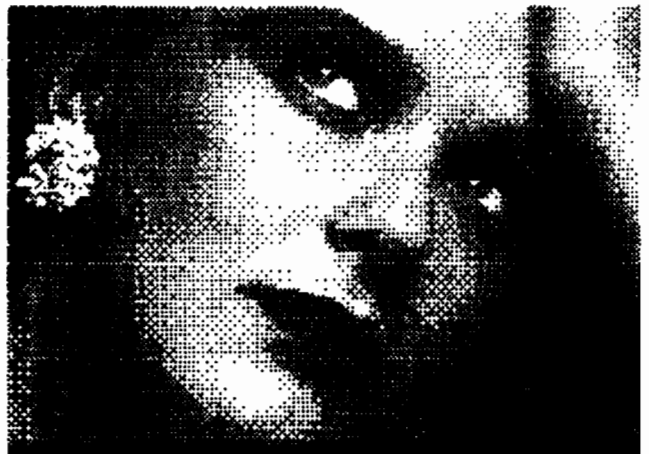

horizontal or vertical for tabs, and right or left for margins. After the first keystroke the cursor is moved in front of the secondary choices to indicate the required action. After the second keystroke the value is entered. If, at any time, an invalid keystroke is entered the program simply returns to the main menu cursor location. In the case of tabs, up to eight tab locations can be entered, separated by commas.

Listing 1

```

10 REM *****
12 REM *
14 REM *      TIGER SETUP      *
16 REM *
18 REM *      BY      *
20 REM *
22 REM *      TERRY L ANDERSON  *
24 REM *
26 REM *      WALLA WALLA COLLEGE *
28 REM *
30 REM *      BEGUN      1981 FEB 03 *
32 REM *      LAST MOD 1981 FEB 19 *
34 REM *
36 REM *      MENU DRIVEN PROG TO *
38 REM *      CONFIGURE PAPER *
40 REM *      TIGER 460 FEATURES *
42 REM *
44 REM *      CHANGE LINE 110 TO *
46 REM *      PRINTER SLOT# *
48 REM *
50 REM *****
99 REM
100 REM
INITIALIZE
110 SL = 1: REM PRINTER SLOT#
120 T$ = "TIGER SETUP"
130 V$ = "VER 81-FEB-19"
140 D$ = CHR$(4): REM CTRL-D
150 E$ = CHR$(27): REM (ESC)
160 N$ = "." + CHR$(0): REM END
ING FOR ESC FUNC'S
170 FL% = 528
180 PS% = 48
190 AL% = 8: AG% = 4: AO% = - 4
200 VT$ = "0,0,0,0,0,0,0,0": HT$ =
210 REM
MENU
220 HOME : VTAB 1: HTAB 20 - LEN
(T$) / 2: PRINT T$
230 VTAB 3: HTAB 20 - LEN (V$) /
2: PRINT V$
240 VTAB 5
250 INVERSE : PRINT "G": NORMAL
: PRINT "GRAPHIC MODE "
260 IF C% THEN PRINT "OFF/": INVERSE
: PRINT "ON": NORMAL: GOTO 280
270 INVERSE : PRINT "OFF": NORMAL
: PRINT "/ON"
280 INVERSE : PRINT "J": NORMAL
: PRINT "JUSTIFY MODE "
290 IF J% THEN PRINT "OFF/": INVERSE
: PRINT "ON": NORMAL: GOTO 310
300 INVERSE : PRINT "OFF": NORMAL
: PRINT "/ON"
310 INVERSE : PRINT "P": NORMAL
: PRINT "PROPORTIONAL SPACING
"
320 IF P% THEN PRINT "OFF/": INVERSE
: PRINT "ON": NORMAL: GOTO 340
330 INVERSE : PRINT "OFF": NORMAL
: PRINT "/ON"
340 INVERSE : PRINT "L": NORMAL
: PRINT "LINE SPACING "
350 IF AL% = 6 THEN PRINT "6/":
INVERSE : PRINT "8": NORMAL
: PRINT "LPI": GOTO 380
360 IF AL% = 8 THEN INVERSE : PRINT
"6": NORMAL: PRINT "/8 LPI
": GOTO 380
370 PRINT "6/8 LPI ": INVERSE :
PRINT "SPECIAL SEE ADV LF":
NORMAL
380 INVERSE : PRINT "A": NORMAL
: PRINT "DVANCE ": INVERSE
: PRINT "L": NORMAL: PRINT
"F ": INVERSE : PRINT AL%:
NORMAL: PRINT "
/
48TH INCH"
390 HTAB 10: INVERSE : PRINT "C"
: NORMAL: PRINT "GRAPHIC LF
": INVERSE : PRINT AG%: NORMAL
400 HTAB 10: INVERSE : PRINT "O"
: NORMAL: PRINT "OTHER ": INVERS
E : PRINT AO%: NORMAL
410 INVERSE : PRINT "C": NORMAL
: PRINT "CHAR SPACING "
420 IF C% = 0 THEN C% = 4
430 IF C% = 1 THEN INVERSE : PRINT
"5": NORMAL: PRINT ",6,8,4
,10,12,16,8": GOTO 490
440 IF C% = 2 THEN PRINT "5,":
INVERSE : PRINT "6": NORMAL
: PRINT ",8,4,10,12,16,8": GOTO
490
450 IF C% = 3 THEN PRINT "5,6,
": INVERSE : PRINT "8,4": NORMAL
: PRINT ",10,12,16,8": GOTO
490

```

```

460 IF C% = 4 THEN PRINT "5,6,8
,4,": INVERSE : PRINT "10":
NORMAL: PRINT ",12,16,8":
GOTO 490
470 IF C% = 5 THEN PRINT "5,6,8
,4,10,": INVERSE : PRINT "1
2": NORMAL: PRINT ",16,8":
GOTO 490
480 IF C% = 6 THEN PRINT "5,6,8
,4,10,12,": INVERSE : PRINT
"16,8": NORMAL: GOTO 490
490 PRINT "CPI"
500 INVERSE : PRINT "I": NORMAL
: PRINT "INTERCHAR SPACING "
: INVERSE : PRINT "IS%": NORMAL
: PRINT " /24TH CHAR WIDTH"
510 INVERSE : PRINT "M": NORMAL
: PRINT "ARGIN ": INVERSE
: PRINT "L": NORMAL: PRINT
"EFT ": INVERSE : PRINT ML
%: NORMAL: PRINT " /120TH
INCH"
520 HTAB 9: INVERSE : PRINT "R":
NORMAL: PRINT "IGHT ": INVERSE
: PRINT MR%: NORMAL
530 INVERSE : PRINT "F": NORMAL
: PRINT "FORMS LENGTH ": INVERSE
: PRINT FL%: NORMAL: PRINT
" /48TH INCH (=):FL% / 48":
INCH"
540 INVERSE : PRINT "S": NORMAL
: PRINT "IZE PAGE SKIP ": INVERSE
: PRINT PS%: NORMAL: PRINT " /4
8TH INCH (=):PS% / 48": INC
H)
550 INVERSE : PRINT "T": NORMAL
: PRINT "ABS ": INVERSE : PRINT
"H": NORMAL: PRINT "ORIZ "
: INVERSE : PRINT HT%: NORMAL
: PRINT " /120TH INCH"
560 HTAB 7: INVERSE : PRINT "V":
NORMAL: PRINT "ERT ": INVERSE
: PRINT VT%: NORMAL: PRINT " /4
8TH INCH"
570 PRINT : INVERSE : PRINT "Q":
NORMAL: PRINT "UIT AND CO
NFIGURE PRINTER"
580 PRINT : PRINT "SET ":
590 POKE 49168,0: REM CLR KB STR
OBE
600 GET A$
610 REM
NOTE REQUESTED CHANGE
620 IF A$ = "C" THEN C% = NOT C
%: GOTO 960
630 IF A$ = "J" THEN J% = NOT J
%: GOTO 960
640 IF A$ = "P" THEN P% = NOT P
%: GOTO 960
650 IF A$ < > "L" THEN 680
660 IF AL% = 8 THEN AL% = 6: GOTO
960
670 AL% = 8: GOTO 960
680 IF A$ < > "A" THEN 740
690 VTAB 09: HTAB 8: GET A$
700 IF A$ = "L" THEN HTAB 12: INPUT
AL%: GOTO 960
710 IF A$ = "G" THEN VTAB 10: HTAB
20: INPUT AG%: GOTO 960
720 IF A$ = "O" THEN VTAB 11: HTAB
15: INPUT AO%: GOTO 960
730 GOTO 960
740 IF A$ < > "C" THEN 760
750 C% = C% + 1: IF C% > 6 THEN C
% = 1: GOTO 960
760 IF A$ < > "I" THEN 780
770 VTAB 13: HTAB 18: INPUT IS%:
GOTO 960
780 IF A$ < > "M" THEN 830
790 VTAB 14: HTAB 7: GET A$
800 IF A$ = "L" THEN VTAB 14: HTAB
14: INPUT ML%: GOTO 960
810 IF A$ = "R" THEN VTAB 15: HTAB
14: INPUT MR%: GOTO 960
820 GOTO 960
830 IF A$ < > "T" THEN 930
840 VTAB 18: HTAB 5: GET A$
850 IF A$ < > "H" THEN 890
860 VTAB 18: HTAB 12: HT$ = ""
870 GET A$: IF A$ < > CHR$(13
) AND A$ < > CHR$(141) THEN
HT$ = HT$ + A$: PRINT A$: GOTO
870
880 GOTO 960
890 IF A$ < > "V" THEN 920
900 VTAB 19: HTAB 12: VT$ = ""
910 GET A$: IF A$ < > CHR$(13
) AND A$ < > CHR$(141) THEN
VT$ = VT$ + A$: PRINT A$: GOTO
910
920 GOTO 960
930 IF A$ = "F" THEN VTAB 16: HTAB
13: INPUT FL%: GOTO 960

```

(Continued)

Listing 1 (Continued)

```

940 IF A$ = "S" THEN VTAB 17: HTAB
    15: INPUT PS$: GOTO 960
950 IF A$ = "Q" THEN 970
960 GOTO 210
970 REM
CONFIGURE TIGER

980 CS$ = ""
990 IF P% THEN CS$ = CS$ + CHR$
    (16)
1000 IF NOT P% THEN CS$ = CS$ +
    CHR$ (6)
1010 IF J% THEN CS$ = CS$ + CHR$
    (4)
1020 IF NOT J% THEN CS$ = CS$ +
    CHR$ (3)
1030 IF C% < 4 THEN CS$ = CS$ +
    CHR$ (1)
1040 IF C% = ) 4 THEN C% = C% -
    3: CS$ = CS$ + CHR$ (2)
1050 CS$ = CS$ + CHR$ (28 + C%)
1060 CS$ = CS$ + E$ + ",B," + STR$
    (AL%) + N$

```

```

1070 CS$ = CS$ + E$ + ",C," + STR$
    (AC%) + N$
1080 CS$ = CS$ + E$ + ",D," + STR$
    (AO%) + N$
1090 CS$ = CS$ + E$ + ",E," + VT$
    + N$
1100 CS$ = CS$ + E$ + ",F," + HT$
    + N$
1110 CS$ = CS$ + E$ + ",J," + STR$
    (ML%) + ", " + STR$ (MR%) +
    N$
1120 CS$ = CS$ + E$ + ",L," + STR$
    (FL%) + ", " + STR$ (FL% - P
    S%) + N$
1130 CS$ = CS$ + E$ + ",P," + STR$
    (IS%) + N$
1140 IF G% THEN CS$ = CS$ + CHR$
    (3)
1150 PRINT
1160 PRINT D$;"PR#";SL
1170 PRINT CS$
1180 PRINT D$;"PR#0"
1190 HOME : PRINT "TIGER CONFIGU
    RED": END

```



The only change an Apple owner with a Paper Tiger 460 may need to make is to change the variable SL in line 110 to indicate the slot number of his printer interface. For 460 owners with other computers, the program should be fairly easy to adapt. If you do not have reverse video through a function like Apple's 'INVERSE,' a different method of indicating the chosen option must be substituted. Also, the single keystroke method is only possible if a single key input function such as GET is available. Note that GET was also used to input the string for the tabs. On the Apple, a comma in a string INPUT results in multiple strings, not a single string, unless the entry is typed with quotes (a nuisance to be avoided).

The program consists of four parts: documentation and initialization (lines 10-200), the menu printer (lines 210-590), the keystroke interpreter (lines 600-960), and the command character transmitter (lines 970-1190). The menu printer portion looks very complicated because of the difficulties in turning inverse on and off and in maintaining the current value and state of each option.

I did find one error in my copy of the Paper Tiger 460 manual. My copy is marked 'preliminary' — hopefully it will be fixed in the permanent manual. On page 3-14 and 3-15 where it describes the 'form size' feature, table 3-4 indicates two parameters required while the description and example discuss only one. Two is the correct required number (the second one is *not* optional), so the example given will cause the printer to simply ignore the command and keep the old value of form size. The first parameter should be the total form size in 48ths of an inch as in the example. The second parameter should be the printed portion exclusive of the desired skip, also in 48ths of an inch. For example, if you want a 4.5 inch form with a one-half inch skip (thus 4 inches used for print) the correct command is:

<ESC> ,L,216,24,<CR>

TIGER SETUP allows you to indicate the skip size rather than the printed portion size, a method I find easier.

It appears that some modes of the printer interfere with others. For example, auto-justify and proportional modes cannot be used simultaneously; the proportional mode takes precedence and overrides the auto-justify mode.

```

ASM                                     Listing 2
1000 *****
1005 *
1010 *           TIGER DUMP
1015 *
1020 *           BY
1025 *
1030 *           TERRY L ANDERSON
1035 *
1040 * BEGUN           1981 JAN 09
1045 * LAST MODIFIED  1981 FEB 22
1050 *
1055 * WILL DUMP 8192 BYTES OF DATA
1060 * (USUALLY HI-RES SCREEN 1 OR
1065 * 2) TO THE IDS460 PAPER TIGER
1070 *
1075 * USEFUL INTERNAL ADDR:
1080 *
1085 * 6000 24576 ENTRY
1090 *
1095 * 6001 24577 HPAG-HI BYTE OF
1100 * BUFFER TO PRINT
1105 * (DEF $20)
1110 *
1115 * 6040 24640 NUMLIN-# OF HI-
1120 * RES HORIZ LINES
1125 * (DEF $C0=192)
1130 *
1135 * 609D 24733 INVMSK-MASK BYTE
1140 * $00-NORMAL (DEF)
1145 * $7F-INVERSE VID
1150 *
1155 * 6124 24868 SLOT OFFSET--
1160 * SLOT# * $10
1165 * $10-SLOT 1 (DEF)
1170 *
1175 * 6125 24869 EXPANDED PLOT --
1180 * $00-NORMAL (DEF)
1185 * $80-EXPANDED *2
1190 *
1195 *****
1200
1300 *** ZERO PAGE LOC'S ***
1310
0026- 1320 HBASL .EQ $26      BASE ADDR FOR
0027- 1330 HBASH .EQ $27      CUR HIRES LN
0030- 1340 ZSTOR .EQ $50      ZPAGE STORAGE
1350 * NEEDS $10 BY
0032- 1360 BASL0 .EQ ZSTOR+$2 HCR BYT PTR
0033- 1370 BASH0 .EQ ZSTOR+$3 TBL(ROW7, 1)
00E6- 1380 HPAG .EQ $E6        HBYTE OF ADDR
1390 * GRAF BUFFER
1400 *** MON CALLS ***
1410
1420
1430 *** A/S BASIC CALLS ***
1440
F411- 1450 HPOSN .EQ $F411     SETS HBASL,H
1460
1470
1480 *** HARDWR ADDR ***
1490 *
C084- 1500 STATUS .EQ $C084   STATUS REG
C084- 1510 CNTRL .EQ $C084   CONTROL REG
C085- 1520 OUTPRT .EQ $C085  OUTPORT REG
1530 *
1540 *** OTHER CONST ***
1550
0020- 1560 GRBUF .EQ $20      HBYTE OF ADDR
1570 * GRAF BUFFER
00C0- 1580 NUMLIN .EQ 192    # OF GR ROWS
000F- 1590 SAVSIZ .EQ $F     #BYTES-1 TO
1600 * SAVE FOR TBL
1610 * PAPER TIGER CONTROL CODES
1620 *
0003- 1630 GRMODE .EQ $03    CTRL-C
0003- 1640 GRPFIX .EQ $03    CMD PREFIX
1650 * WHILE IN GR
000E- 1660 GRAFLF .EQ $0E    GRAPHIC LF
0002- 1670 NORMOD .EQ $02    NORMAL MODE
0009- 1680 HTAB .EQ $09     CTRL-I
0000- 1690 INVMSK .EQ $00    INVERSE MASK
1700 * USE $7F TO
1710 * INVERSE PIX
0010- 1720 SLOT1 .EQ $10      SLOT OFFSET
1730 * FOR SLOT 1
1740
1750
1800 *** ORIGIN ***
1810
1820 .OR $6000      CALL 24576
1830 .TA $6000
1840
1850
1860
1870
1880
1890
1900
1910
1920
1930
1940
1950
1960
1970
1980
1990
2000 DUMP LDA #GRBUF      NORMAL ENTRY
2010 STA HPAG           INIT HPAG
2020 LDA #00
2030 STA RONUMH        INIT ROW
2040 STA RONUML
2050
2060 * RESET ACIA & INIT FOR DEFAULT
2070 * 8 BIT; 2 STOP; /16 CLOCK
2080 * DISABLE INTERRUPTS
2090
2100 LDY SLOT           GET SLOT#
2110 LDA #$03
2120 STA CNTRL,Y       RESET ACIA
    
```

(Continued)

Listing 2 (Continued)

```

6014- A9 11 2130 LDA #11
6016- 99 84 C0 2140 STA CNTRL, Y SET DEFAULTS
2150
6019- A2 00 2160 SAVEZP LDX #00 SAVE CONT OF
601B- E5 50 2170 SAVE1 LDA ZSTOR, X TABLE SPACE
601D- 48 2180 PHA TO RESTORE
601E- E8 2190 INX
601F- E0 10 2200 CPX #SAVSIZ+1 DONE?
6021- D0 F8 2210 BNE SAVE1 NO, NEXT
2220
6023- 20 E1 60 2230 JSR PUTSTR SEND CONTROLS
6026- 0E 2240 .DA #GRAFLF DUMP BUFF
6027- 03 2250 .DA #GRMODE GRAPHIC MODE
6028- 00 2260 .HS 00 END STRING
2270
*** PRINT LINE OF 7 ROWS
2280
6029- A9 0E 2300 PRLINE LDA #0E INIT ROW INDX
602B- 8D 1B 61 2310 STA ROWDEX 1 OF 7 *2
2320
602E- A2 00 2330 PRLIN1 LDX #00 INIT COLUMN L
6030- A0 00 2340 LDY #00 COLUMN H
6032- AD 1A 61 2350 LDA RNUMH GET ROWNUM/2
6035- 4A 2360 LSR
6036- AD 19 61 2370 LDA RNUML
6039- 2C 25 61 2380 BIT DOUBLE CHK EXPAND?
603C- 10 01 2390 BPL PRLIN2 NO, OK
603E- 6A 2400 ROR YES, /2
603F- C9 C0 2410 PRLIN2 CMP #NUMLIN DONE NUMLINS?
6041- D0 06 2420 BNE PRLIN3 NO, OK
6043- A9 80 2430 LDA #80 YES, SET BIT7
6045- 8D 1A 61 2440 STA RNUMH INDIC DONE
6048- 38 2450 SEC SET DONE
6049- CE 1B 61 2460 PRLIN3 DEC ROWDEX DEC LOF7
604C- CE 1B 61 2470 DEC ROWDEX TWICE
604F- 30 1C 2480 BMI PRLIN5 ROWDEX<0; DONE
6051- B0 1A 2490 BCS PRLIN5 =NUMLIN; DONE
6053- Z0 11 F4 2500 JSR HPOSN SET HBAS
6056- AC 1B 61 2510 LDY ROWDEX SAVE HBAS
6059- A5 26 2520 LDA HBASL FOR EACH
605B- 99 52 00 2530 STA BASL0, Y ROW
605E- A5 27 2540 LDA HBASH
6060- 99 53 00 2550 STA BASH0, Y
6063- EE 19 61 2560 INC RNUML INC ROWNUM
6066- D0 03 2570 BNE PRLIN4
6068- EE 1A 61 2580 INC RNUMH
606B- D0 C1 2590 PRLIN4 BNE PRLIN1 ALWAYS TAKEN
606D- A0 27 2600 PRLIN5 LDY #27 INIT COLUMN
606F- 8C 1C 61 2610 STY COLBYT BYTE CNT
2620
*** PRINT 7 COLUMNS OF 7
2630
6072- A0 08 2650 PR7COL LDY #6 INIT ROW INDX
6074- A2 0C 2660 LDX #0C INIT ROW *2
6076- A1 52 2670 PR7C1 LDA (BASL0, X) GET GRAF BYT
6078- 99 1D 61 2680 STA ROWBYT, Y STO FOR PRINT
607B- F6 52 2690 INC BASL0, X SET FOR NXT
607D- 88 2700 DEY DEC ROW
607E- CA 2710 DEX & X TWICE
607F- CA 2720 DEX
6080- EC 1B 61 2730 CPX ROWDEX =ROWDEX?
6083- D0 F1 2740 BNE PR7C1 NO, NXT BYTE
6085- A0 07 2750 LDY #07 8 BITS, 0 1ST
2760
6087- AD 1B 61 2770 PR1COL LDA ROWDEX ROWS ROWDEX *7
608A- 4A 2780 LSR /2
608B- AA 2790 TAX USE AS INDEX
608C- E8 2800 INX +1
608D- A9 00 2810 LDA #00 CLR ACC
608F- 7E 1D 61 2820 PR1C1 ROR ROWBYT, X EACH BYTE
6092- 2A 2830 ROL INTO ACCUM
6093- E8 2840 INX
6094- E0 07 2850 CPX #07 GOT 7?
6096- D0 F7 2860 BNE PR1C1 NO, NEXT
6098- C0 00 2870 CPY #00 Y, BIT0'S?
609A- F0 11 2880 BEQ PR1C3 Y, DON'T PRINT
609C- 49 00 2890 EOR #INVMASK NO, APPLY MASK
609E- 29 7F 2900 AND #67F KEEP BIT7=0
60A0- 2C 25 61 2910 BIT DOUBLE CHK EXPANDED?
60A3- 10 05 2920 BPL PR1C2 NO, OUT ONCE
60A5- 48 2930 PHA YES, SAVE ACC
60A6- 20 D4 60 2940 JSR OUTBYT EXTRA OUT
60A9- 68 2950 PLA RESTOR ACC
60AA- 20 D4 60 2960 PR1C2 JSR OUTBYT MAIN OUT
60AD- 88 2970 PR1C3 DEY NXT COL OF 7
60AE- 10 D7 2980 BPL PR1COL DONE?NO, NEXT
2990
60B0- CE 1C 91 3000 DEC COLBYT NXT 7 COL'S
60B3- 10 BD 3010 BPL PR7COL DONE?N, NXT 7
60B5- 20 E1 60 3020 JSR PUTSTR Y, SEND (CR)
60B8- 03 3030 .DA #GRFFIX & (GR LF)
60B9- 0E 3040 .DA #GRAFLF
60BA- 00 3050 .HS 00 END STR
60BB- 2C 1A 61 3060 BIT RNUMH LAST 7 ROWS?
60BE- 30 03 3070 BMI DONE LAST?Y, DONE
60C0- 4C 29 60 3080 JMP PRLINE N, NEXT LINE
3090
60C3- 20 E1 60 3100 DONE JSR PUTSTR EXIT GRAF
60C6- 03 3110 .DA #GRFFIX MODE
60C7- 02 3120 .DA #NORMOD
60C8- 0E 3130 .DA #GRAFLF &2<GR LF>'S
60C9- 0E 3140 .DA #GRAFLF
60CA- 00 3150 .HS 00 END STR
3160
60CB- A2 0F 3170 RESTZP LDX #SAVSIZ RESTORE
60CD- 69 3180 REST1 PLA ZPAGE USED
    
```

(Continued)

TIGER DUMP

We also need a way to print graphic material which has been developed on Apple's Hi-Res screen. The preliminary manual gives no information about the graphic mode except how to get into it (not even how to get out). Fortunately, I had had some experience with the Paper Tiger 440 and suspected they would be similar. The only significant differences are that the 460 prints seven dot rows (not all nine) in each head pass across the page instead of six and that <SO> or control-N is used as a 'graphic' line feed [move paper exactly seven dot rows] rather than a <VT> or control-K as on the 440.

TIGER DUMP takes data stored in Apple's RAM in Hi-Res screen buffer format and reorganizes the information to construct bytes consisting of seven dots in a column, one for each of the seven rows. A one indicates a dot that is 'on' and a zero indicates a dot that is 'off.' It then sends 280 such seven-dot columns to form one print head pass, printing seven horizontal rows. It repeats with another seven rows until all the data is printed. Unfortunately, seven does not go evenly into 192, the number of rows in Apple's Hi-Res screen. The last seven rows only have four rows of data, so zeros are assumed for the other rows and they are printed. This means that another Hi-Res screenful cannot be printed immediately, adjoining the previous one. Three blank lines will separate them. It's difficult to print larger pictures when you use multiple screenfuls. I wish the 460 would use eight print wires and use all eight bits of the data bytes. It would then run 14% faster and not have extra lines left over.

TIGER DUMP includes several features I have not seen in other graphic dump programs. These features are chosen by POKeIng new values for any of five parameters. You can specify the number of lines to print, allowing only a part of the Hi-Res buffer to be printed (the part must be at the top as viewed, i.e. at beginning of buffer). You can specify the location of the buffer allowing use of Hi-Res screen two or any other 8K bytes of memory as long as it is in Hi-Res buffer format. Hi-Res buffers are organized so that lines that appear adjacent on the screen are not stored next to each other. Any data to be printed with this program must be stored exactly like a Hi-Res buffer, but it need not be in Hi-Res page one or two. This would allow several screenfuls to be BLOADED into memory wherever there is free room, and then printed.

An inverse or reverse video mask is used so you can invert a picture while printing, but the stored picture is not affected as in the programs I have seen for the 440. Several of them EOR (exclusive-or) all the bytes of the Hi-Res page before printing. TIGER DUMP simply applies the mask to each constructed byte before sending it, but does not affect the stored bytes. Each of the first seven bits of the mask byte affect one of the seven rows; a zero leaves it unaffected, a one inverts it. The mask byte \$7F or \$FF would invert the entire picture and \$00 would print it normally. A stripped effect can be obtained by experimenting with other mask bytes. For example, \$55 = 01010101 and \$2A = 00101010 would invert alternate rows.

The inversion feature is particularly helpful when printing nearly 'photographic' pictures such as those in the Apple Software Bank Contributed Program Slide Shows. On the Apple screens, one-bits result in a light dot on a dark background, but on the printer, a one normally yields a black dot on white paper. The result is a print which looks like a negative. This is desirable for a line drawing. Inverting a picture gives it a more satisfying result.

The higher resolution of the 460 compared to the 440 results in much smaller prints if you use the minimum dot spacing (84/inch) for each Hi-Res dot. The total print for 280 dots by 192 dots is only 3.33 by 2.29 inches. This is nice for some applications but often a larger print size is desirable. You could use alternate dot locations on the printer, resulting in 42 dots/inch and a print doubled in size, but that would result in white spaces between dots causing black regions to appear gray.

A better method is to map each Hi-Res dot into a 2 by 2 pattern of dots; each Hi-Res dot becomes a big dot. Then the dots still overlap, allowing solidly printed regions, but the image is twice as large. No additional detail is allowed though the print is larger, because no smaller detail information can be stored in Apple's Hi-Res buffer. TIGER DUMP allows the user to choose between the small size print or the expanded print with the default being the small size.

To use TIGER DUMP simply prepare the Hi-Res buffer or BLOAD a stored picture and BRUN TIGER DUMP.

Listing 2 (Continued)

```

60CE- 95 50      3190      STA ZSTOR,X
60D0- CA        3200      DEX
60D1- 10 FA        3210      BPL REST1
                        3220
60D3- 60        3230      RETURN RTS          RTN FORM DUMP
                        3240
                        3250      *****
                        3260      * SUBR OUTBYTE *
                        3270      *   OUTPUTS BYTE CHECKING FOR *
                        3280      *   GRAPHIC PREFIX & DEL'ING *
                        3290      *****
                        3300
60D4- C9 03      3310      OUTBYT CMP #GRPFIX  CHK
60D6- D0 05      3320      BNE OUTB1      NO,OUT ONCE
60D8- 20 00 61   3330      JSR COUT        Y,OUT TWICE
60DB- A9 03      3340      LDA #GRPFIX    FOR SECOND
60DD- 20 00 61   3350      OUTB1 JSR COUT    PRINT IT
60E0- 60        3360      RTS          RETURN
                        3370
                        3380      *****
                        3390      *
                        3400      *   SUBR PRINT STRING *
                        3410      *
                        3420      *   1981 JAN 11 *
                        3430      *
                        3440      * SUBR WILL PRINT THE STRING *
                        3450      * THAT IMMEDIATELY FOLLOWS THE *
                        3460      * JSR AND ENDS WITH A NULL OR *
                        3470      * ASCII 00 *
                        3480      * NOTE: USES $FE,FF FOR TEMP *
                        3490      * STORAGE OF RETURN ADDR. *
                        3500      *
                        3510      *****
                        3520
                        3530      *** ZERO PAGE LOC'S
0050-          3550      TEMPL EQ ZSTOR    TEMP STORAGE
0051-          3560      TEMPH EQ TEMPL+1  FOR RTN ADDR
                        3570
                        3580
60E1- 68        3590      PUTSTR PLA          SAVE RTN ADDR
60E2- 85 50      3600      STA TEMPL
60E4- 68        3610      PLA
60E5- 85 51      3620      STA TEMPH
60E7- A0 00      3630      PUTST1 LDY #00      OFFSET
60E9- E6 50      3640      INC TEMPL    INC POINTER
60EB- D0 02      3650      BNE PUTST2
60ED- E6 51      3660      INC TEMPH
60EF- B1 50      3670      PUTST2 LDA (TEMPL),Y LOAD CHR
60F1- F0 06      3680      BEQ PUTST3   0?Y,DONE
60F3- 20 00 61   3690      JSR COUT        N,PRINT
60F6- 38        3700      SEC
60F7- B0 EE      3710      BCS PUTST1   ALWAYS TAKEN
60F9- A5 51      3720      PUTST3 LDA TEMPH    RESTORE
60FB- 48        3730      PHA          UPDATED
60FC- A5 50      3740      LDA TEMPL    RETURN
60FE- 48        3750      PHA          ADDR
60FF- 60        3760      RTS
                        3770      *** END SUBR PUT STRING ****
                        3780
                        3790      *****
                        3800      * SUBR COUT *
                        3810      *****
                        3820
                        3830      * PUTS CHAR OUT THRU ACIA
                        3840      * DIRECTLY
                        3850
6100- 8D 18 61   3860      COUT STA ACCSAV   SAVE ACC
6103- 98        3870      TYA          & Y REG
6104- 48        3880      PHA
6105- AC 24 61   3890      LDY SLOT    INDEX BY SLOT
6108- B9 84 C0  3900      COUT1 LDA STATUS,Y GET ACIA STAT
610B- 29 02      3910      AND #02     CHK READY
610D- F0 F9      3920      BEQ COUT1   NOT? LOOP
610F- AD 18 61   3930      LDA ACCSAV  RESTOR ACC
6112- 99 85 C0  3940      STA OUTPRT,Y & PUT OUT
6115- 68        3950      PLA          RESTORE
6116- A8        3960      TAY          Y
6117- 60        3970      RTS          RETURN
                        3980
                        3990      *** END SUBR COUT ***
4000      *** LOCAL DATA ***
4010
6118-          4020      ACCSAV .BS $1    SAVE ACCUM
6119-          4030      RONUML .BS $1    ROWNUM
611A-          4040      RONUMH .BS $1    HI BYTE 0..1
                        4050      *          $80-INDIC
                        4060      *          REACH NUMLIN
611B-          4070      ROWDEX .BS $1    0..13 OR $D
611C-          4080      COLBYT .BS $1    COLUMNBYT CNT
611D-          4090      ROWBYT .BS $7
6124- 10        4100      SLOT .DA #SLOT1  SLOT OFFSET
                        4110      *          $NO
6125- 00        4120      DOUBLE .DA #00    EXPANDED PLOT
                        4130      *          = $80; NORM = 00
                        4140
                        4150      *** END OF TIGER DUMP ***
                        4160
                        4170      ZEND .EN

```

SYMBOL TABLE

6118-	ACCSAV
0053-	BASH0
0052-	BASL0
C084-	CNTRL

FIDO PUPPY FARM (PROPORTION OF BREEDS)

- A=POODLE 5%
- B=COLLIE 15%
- C=GERMAN SHEP. 20%
- D=MONGREL 30%
- E=TERRIER 15%
- F=BEAGLE 15%

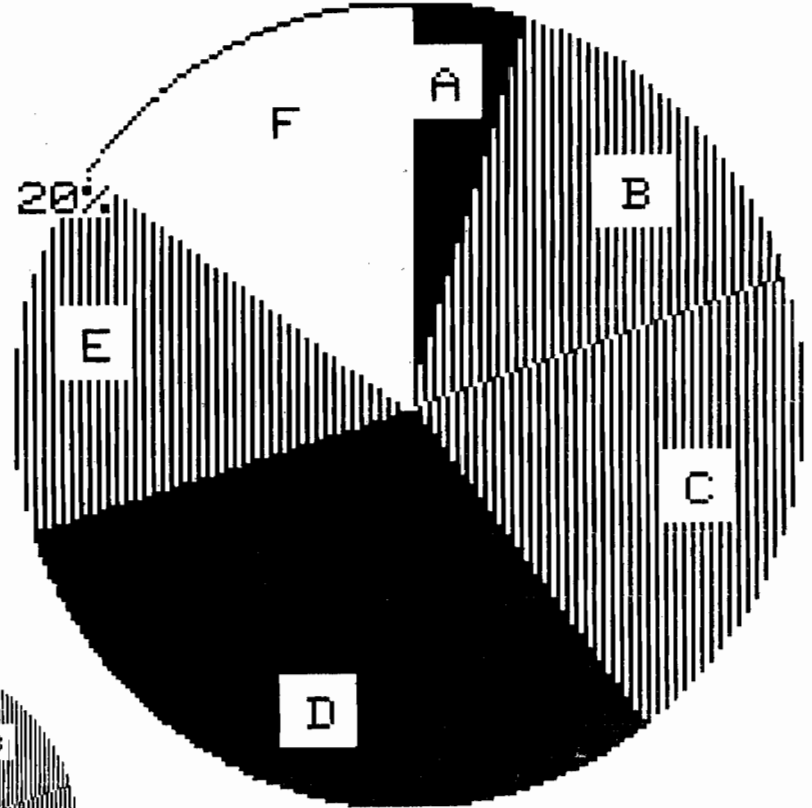

FIDO PUPPY FARM
(PROPORTION OF BREEDS)

- A=POODLE 5%
- B=COLLIE 15%
- C=GERMAN SHEP. 20%
- D=MONGREL 30%
- E=TERRIER 15%
- F=BEAGLE 15%

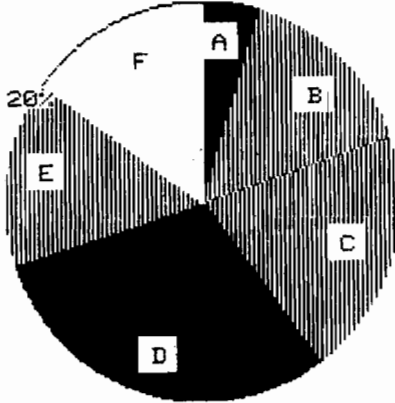

If you wish to use any of the options:

1. BLOAD TIGER DUMP.
2. Modify \$6001 or 24577 to the high byte of the buffer location if it is not Hi-Res page one; for example, for Hi-Res page two, change it to \$40 or 64.
3. Modify \$6040 or 24640 to the number of lines to be printed if less than 192.
4. Set the inverse mask at \$609D or 24733 if you want any lines inverted; a \$7F or 127 will invert the whole picture.
5. Change \$6125 or 24869 from \$00 to \$80 or 128 if you want an expanded print.
6. Call \$6000 or 24576 to run.

BSAVE TIGER DUMP INVERTED, A\$6000, L\$126 if you want a copy of this new version.

TIGER DUMP is located just above Hi-Res page two. If it is to be used with a BASIC program you should protect the Hi-Res pages and TIGER DUMP by setting LOMEM: 24870 or greater. This will cause variable storage to begin above TIGER DUMP. If you have an assembler, TIGER DUMP can easily be relocated to any other unused location such as just below DOS (then HIMEM should be moved to below it).

I use slot one for my printer interface. If yours is in another slot change \$6110 or 24848 to \$N0 or N*16 where N is your slot number.

TIGER DUMP contains its own I/O driver in a subroutine called COUT. This saves the necessity of a PR#n call

to the monitor. But more importantly, the I/O driver contained in the firmware of many printer interface cards contains options which are selected by control characters. These often interfere with the 460's use of these characters. The disadvantage of providing my own I/O driver is that the TIGER DUMP is not as universal.

TIGER DUMP was written for use with the serial interface on the AIO serial/parallel interface board by SSM. For other interfaces you might have to change the locations for the output port OUTPRT and the status and control registers, STATUS and CNTRL at \$C085, \$C084, and \$C083 respectively. Apparently some other serial interfaces are compatible. I tried the program with an unmodified California Computer Systems Asynchronous serial card and with no modifications and it worked fine at 1200 baud, but seemed to have some errors [displaced columns] at 9600 baud.

If your interface's I/O routine does not trap any of the control characters, you could eliminate my COUT. This would then allow the use of the standard driver. Simply change calls to COUT to call the monitors standard COUT at \$FDED. Then you can do a PR#N before running TIGER DUMP.

The serial interface should be run at as high a baud rate as possible. Any rate of 1200 or above will allow the printer to print at near its maximum rate in the text mode. In the graphic mode at least five times as many bytes must be sent per inch of head motion (maximum of 16.8 bytes/inch in text and 84 bytes/inch in graphic). Thus even at 1200 bits/sec the printer must wait at the end of each seven row head pass for more data to be transmitted. At 9600 bit/sec, however, there is little delay; the printer is kept busy.

PUTSTR

TIGER DUMP uses a subroutine called PUTSTR that machine language programmers might find useful in other programs. It will print the string that immediately follows the JSR instruction. The string must end with a <null> or ASCII 00. I have found this a

very handy way to print strings for messages and prompts in machine language programs. It takes much less memory than loading each character into the accumulator with a LDA-immediate. The subroutine gets the address of the first byte of the string from the return address on the stack. Then it loads and prints each character until a \$00 is found. Then it pushes a return address on the stack that points to the first instruction beyond the string and does a return from subroutine. This routine will even print strings longer than one page, 256 bytes.

I would like to thank Dr. Claude C. Barnett, who helped me develop many of the ideas in these programs and helped test them on some of his students.

Terry Anderson is Professor of Physics and Computer Science at Walla Walla College. He teaches an introductory physics laboratory course using eight Apples for data acquisition and analysis. He also has an Apple at home which he uses for text editing, program development and, with a DC Hayes modem, as a terminal to the college's HP3000 minicomputer.

Our Hardware Catalog lists the newest 6502/6809-based hardware on the market. (Please see page 80 in this issue.) If you have a product to announce, simply write and request a form.

Hardware Catalog
34 Chelmsford Street
P.O. Box 6502
Chelmsford, MA
01824

Singing the file transfer blues? Then...

Get B.I.T.S.!

Use your Micromodem 1, 1 A 10² Card, or Apple Comm Card³ to:

Send data files, BASIC programs, even machine code

to most computers over phone lines.

Copy anything you see

into a 31K buffer then save it on disk and/or print it under your complete control.

Many more features!

See it at your favorite computer store today.

Trademarks held by:

- 1 - Hayes Microcomputer Products Inc.
- 2 - SSM
- 3 - Apple Computer Inc.

B. I. T. S. is a trademark of:

MicroSoftware Systems
7927 Jones Branch Dr. Suite 400
McLean, Virginia 22102
(703) 385-2944

MICRO



LOGICAL SOFTWARE, INC.

ANNOUNCES:

MAIL EXPRESS

A NEW MAIL LIST UTILITY FOR THE APPLE II.

- Up to 2,200 Names per File
- Sort by Company Name, Customer Name, City, State Zip
- Prints Return Addresses
- Merge up to 16 Files
- Easy User Definable Codes for City, State and Zip to Save Time and Disk Space

This is an easy to use professional quality mail list able to handle large or small files.

Introductory Price \$49.95
\$2.00 Postage & Handling

Logical Software, Inc.
P.O. Box 354
Farmington, MI 48024
(313) 477-2565



© Apple and Apple II are registered trademarks of Apple Computer Inc.

Terrapin Turtle

Be one of the first persons to own your own robot. It's fun, and unlike other pets, the Turtle obeys your commands. It moves, draws, blinks, beeps, has a sense of touch, and doesn't need to be housebroken. You and your Turtle can draw pictures, navigate mazes, push objects, map rooms, and much, much more. The Turtle's activities are limited only by your imagination, providing a challenge for users of all ages. Interfaces, including software for easy control of the Turtle, are available for the Apple, Atari, and S-100 bus computers.

Terrapin will give a free Turtle to the person or persons who develop the best program for the Turtle by March 31, 1982. In addition, Terrapin will pay royalties. For more information, write or call:

Terrapin, Inc.
678 Massachusetts Avenue
Cambridge, MA 02139
(617) 492-8816

Books available from Terrapin

- Turtle Geometry** by Abelson and diSessa
An innovative book using Turtle Graphics to explore geometry, motion, symmetry and topology. MIT Press \$20.00
- Mindstorms** by Seymour Papert
An exciting book about children, computers, and learning. Explains the philosophy of the new LOGO language. Basic Books \$12.95

Artificial Intelligence by Patrick Winston
Explores several issues including analysis of vision and language. An introduction to the LISP language is incorporated in the second section. Addison-Wesley \$18.95

Katie and the Computer by Fred D'Ignazio
A children's picture book adventure about a young girl's imaginary trip inside a computer. Creative Computing \$6.95

Small Computers by Fred D'Ignazio
A book about the future of small computers and robots, aimed at adolescents. Franklin Watts \$9.95



The Perfect Pet™



THE INSPECTOR

These utilities enable the user to examine data both in the Apple's memory and on disks. Simple commands allow scanning through RAM and ROM memory as well as reading, displaying and changing data on disk.

Read and rewrite sections of Random Access files. Reconstruct a blown VTOC. Weed out unwanted control characters in CATALOG listings. UNDELETE deleted files or programs. Repair files that have erroneous data. All without being under program control. and more.....

You may transfer sectors between disks. This allows you to transfer DOS from one disk to another thereby saving a blown disk when all that's blown is DOS itself; or to restore a portion of a blown disk from its backup disk.

Its unique NIBBLE read routine provides a Hi-Res graphical representation of the data on any track allowing you to immediately ascertain whether your disk is 13 sector or 16 sector. Get an I/O error...is it because you have the wrong DOS up? is it because of a bad address field? or a bad data field? or because a track was erased? This will allow you to tell in an instant without blowing away any program in memory.

APPLE DISK & MEMORY UTILITY

- Repairs Blown Disks
- Reads Nibbles
- Maps Disk Space
- Searches Disks
- Searches Memory
- Edits Disk Sectors
- Outputs Screen to Printer
- Displays Memory in HEX/ASCII

The INSPECTOR even lets you search through an entire disk or through on-board memory for the appearance of a string. Now you can easily add lower case to your programs (with LCA).

Do you want to add so-called illegal line numbers into your program? or have several of the same line numbers in a program (like the professional programmers do)? or input unavailable commands (like HIMEM to Integer Basic)? or put quotation marks into PRINT statements? Here's the easy way to do them all!

AND MORE

The INSPECTOR provides a USER exit that will interface your own subroutines with those of the INSPECTOR itself. For example, just put a screen dump routine (sample included in documentation) at HEX 0300 and press CTRL-Z. The contents of the screen page will print to your printer.

ROM RESIDENT ROUTINES

The INSPECTOR utilities come on an easily installed EPROM. This makes them always available for instant use. No need to load a disk and run a program.

FULLY DOCUMENTED

Unlike other software of its kind, The INSPECTOR comes with an EASY to understand manual and reference card. Examples and graphics help even the uninitiated use the power of these utilities. And furthermore, we offer the kind of personal service which you have never experienced from a software vendor before.

See your LOCAL DEALER OR . . .
Mastercard or Visa users call TOLL FREE 1-800-835-2246. Kansas residents call 1-800-362-2421. Or send \$49.95. Illinois residents add \$3 sales tax.

SYSTEM REQUIREMENTS

All Apple II configurations that have access to Integer Basic (either in ROM or RAM) will support The INSPECTOR. Just place the chip in empty socket D8 either on the mother board or in an Integer firmware card. Apple II+ systems with RAM expansion boards or language systems will receive the INSPECTOR on disk to merge and load with INTBASIC.

And...if you have an Apple II+, without either RAM or ROM access to Integer Basic, you will still be able to use The INSPECTOR, because we are making available 16k RAM expansion boards at a very affordable price. Not only will you be able to use The INSPECTOR, but you will also have access to Integer Basic and other languages. These boards normally retail for \$195.00. Our price for BOTH the INSPECTOR and our 16k RAM board is \$195.00, a savings of \$49.95 over the price of purchasing both separately.

Another Quality Product from
Omega Software Products, Inc.
222 S. Riverside Plaza, Chicago, IL 60606
Phone (312) 648-1944

© 1981 Omega Software Products, Inc.
Apple is a registered trademark of Apple Computer, Inc.

BDU3

PET/CBM IEEE 488 to Parallel Printer Interface

The author presents an interface that allows a parallel printer to be connected to PET's IEEE-488 port. This maintains compatibility with PET BASIC CMD and PRINT# commands.

Alan Hawthorne
611 Vista Drive
Clinton, Tennessee 37716

Wouldn't it be nice to avoid shelling out between \$65 and \$150 for an interface board, plus another \$50 for an IEEE 488 interface cable just to be able to interface a non-CBM printer to your PET/CBM? Well, that was the question I was faced with recently after purchasing a new CBM 8032 and 8050 disk drive along with an Integral Data System 460 Paper Tiger, which promised to provide letter-quality printout at dot-matrix speed (and price). An alternative was to use the PET/CBM parallel port for the printer and write a machine language program to output the characters to the printer. However, this solution wasn't too promising since I would not be able to use the BASIC PRINT# statement nor would I be able to list programs, which would be a considerable sacrifice. I was convinced that with a little thought, a few simple logic ICs, and a couple of spare connectors, I could make a functional IEEE-parallel printer interface, and, in addition to the challenge of the project, I could save up to \$150 and still have the output features I wanted. Having been successful in the design and implementation of this project, I will describe it in the event there are other

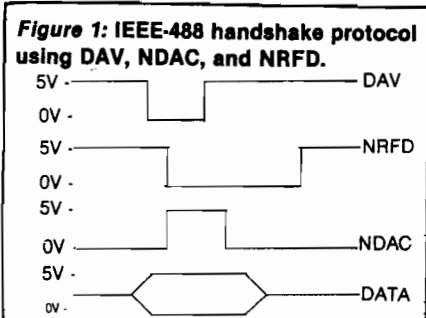
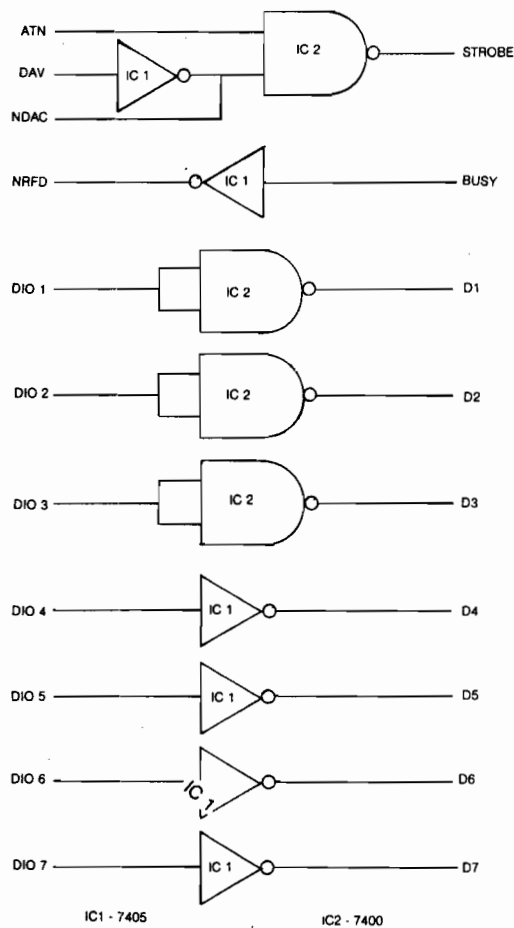

Figure 2: Simple IEEE-printer interface for use when no other IEEE-488 devices are on the bus.



PET/CBM owners with the same need. No guarantee is made as to the conformity of the interface to IEEE standards or as to the validity of your PET/CBM warranty with the interface. However, I have successfully operated the printer interface with my CBM 8032 and 8050 disk drive, as well as a PET 2001, with no detrimental effects.

The IEEE bus consists of three types of signals: data, transfer, and management. Each device on the bus is either a talker or a listener. There are eight data lines which provide the parallel transfer

of data from a talker to a listener, and also provide address information to the devices on the bus, depending on the state of the management signals. The transfer lines implement the handshaking protocol between the talkers and the listeners on the bus. There are three such signals: DAV = data valid, NRFD = not ready for data, and NDAC = data not accepted. The DAV signal originates from the talker, while NRFD and NDAC signals are provided by the listeners. Figure 1 illustrates the handshaking protocol implemented with these transfer signals.

The final group of signals consists of the management lines. There are five of these lines: IFC = interface clear, SRQ = service request, ATN = attention, REN = remote enable, and EOI = end or identify. The management signals control and indicate whether data or device addressing information is on the bus. Not all of these management signals are implemented in the PET/CBM. All bus signals are implemented as negative logic; i.e., a high level corresponds to a zero or false state, while a low level corresponds to a one or true state.

When a BASIC OPEN command is performed, the operating system tells the specified device to listen. Optionally, the secondary address and the file name may be transmitted at the same time. Likewise, a CLOSE command instructs the device associated with that logical unit to unlisten.

A PRINT# command first sends a device listen instruction, then transfers the ASCII characters of the print statement indicating the last character. Thus if a circuit could be designed which would enable data transfer to the printer when a PRINT# statement begins, and disable it at the end of the statement while not listening to other devices' data or addressing instructions, the interface would be achieved.

Interface Design

Figure 2 shows a simple interface which will work with the PET/CBM IEEE port when no other device (including a disk drive) is on the bus. The associated timing diagram is presented in figure 3. The interface is implemented with only two ICs, a 7400 quad dual-input nand gate and a 7405 hex inverter with open-collector outputs. Open-collector outputs are used in order for the NDAC and NRFD handshake signals to be wire ORed with other devices. If your printer will operate with negative logic, then the inverting of the data lines will not be necessary. When addressing information is on the data bus, the ATN line will be held low; while data is on the bus the ATN line remains high. The arrangement in figure 2 will strobe the printer on when ATN*DAV is true, thus providing the needed decoding to distinguish between data and addressing information on the IEEE bus.

When the printer buffer is full, the printer BUSY line provides the necessary handshake signal to NRFD to allow the computer to wait until the printer is no longer busy. This circuit indicates to the PET/CBM that data is

Figure 3: Timing diagram associated with the interface circuit in figure 2.

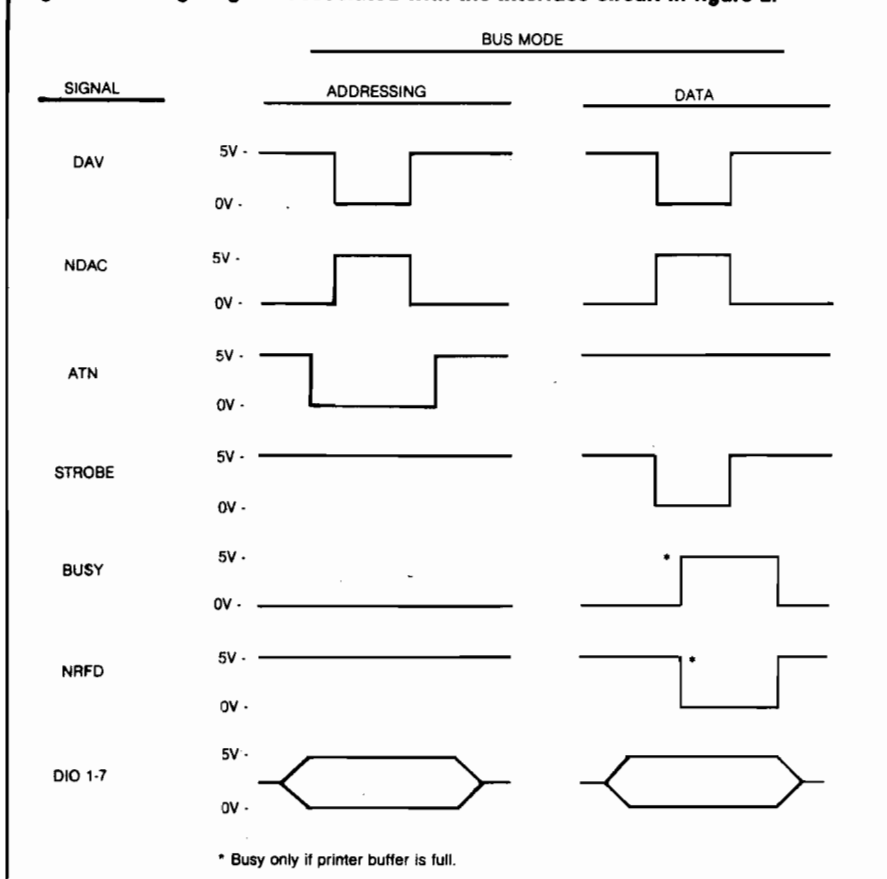

accepted as soon as the IEEE DAV goes low. This requires the printer to latch the data within the time that DAV is low, whereas if implemented as a true IEEE device, the computer would wait until the printer acknowledged receipt of the data. This should not be a limitation for most parallel printers but may be a point to test if the interface doesn't work for you.

If another IEEE device, such as a disk drive, is present, then the simple two-chip circuit of figure 2 will not be adequate to interface the printer. Additional circuitry will be required to decode device addressing. The address decoding is accomplished with a 7470, which is an AND-gated J-K positive-edge-triggered flip-flop with preset and clear. Figure 4 shows the function table for this IC.

For the PET/CBM peripherals, the normal IEEE device addresses are an 8 for the disk drive and a 4 for the printer. These device addresses are assumed in the printer interface design shown in figure 5. As shown in figure 4, Q will be set high on the positive edge of the clock pulse if the J input is high and the K input is low. Likewise, Q will be set low on the positive edge of the clock pulse if the J input is low and the K input is

high. Also Q is set low if the clear input is brought low. These three functions allow the address decoding to be accomplished with only this one IC when the Q output is NANDed with the DAV and ATN bus signals. The appropriate clocking pulse is obtained by NANDing the ATN and DAV signal so that a clock pulse occurs when valid addressing signals are on the IEEE bus. The clock does not function when valid data is on the bus.

When the PET/CBM outputs data to the IEEE port via a PRINT# statement, the following address bytes (ATN low) are output first: a \$2x, where x is the device address, and a \$6y, where y is the secondary address specified in the OPEN statement. An OPEN statement gives a

Figure 4: Functions of a 7470 and-gated J-K positive-edge-triggered flip-flop.

SET	CLR	CLK	J	K	Q	Q̄
L	H	X	X	X	H	L
H	L	X	X	X	L	H
H	H	↑	L	L	Q	Q̄
H	H	↑	H	L	H	L
H	H	↑	L	H	L	H
H	H	↑	H	H	TOGGLE	TOGGLE
H	H	L	X	X	Q	Q̄

↑ — Positive transition.
X — Either level.

Figure 5: IEEE-printer interface with address decoding capability.

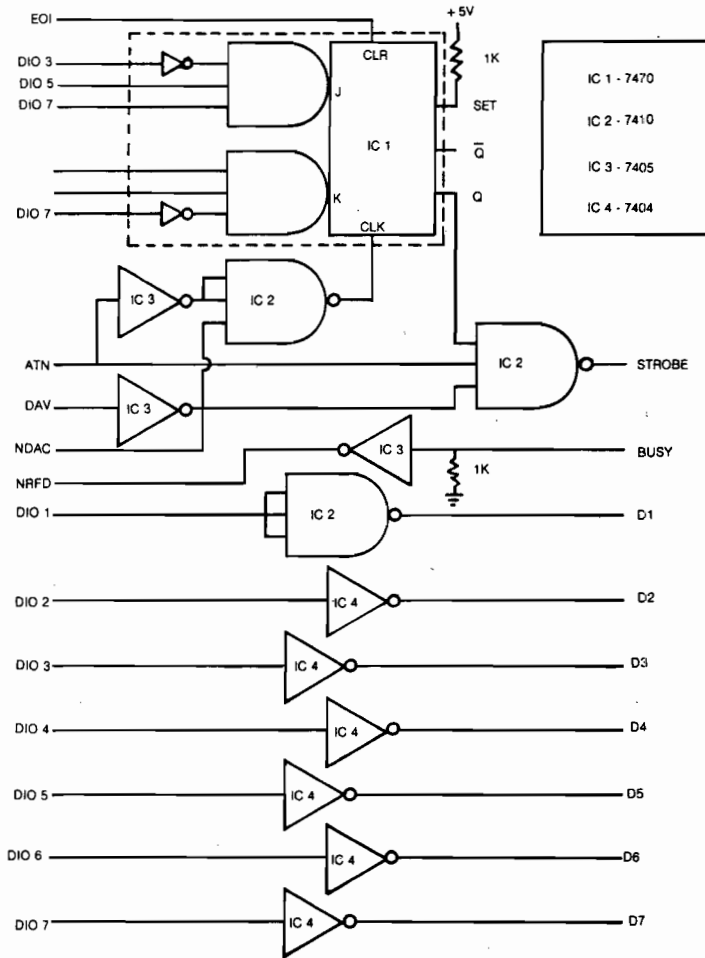
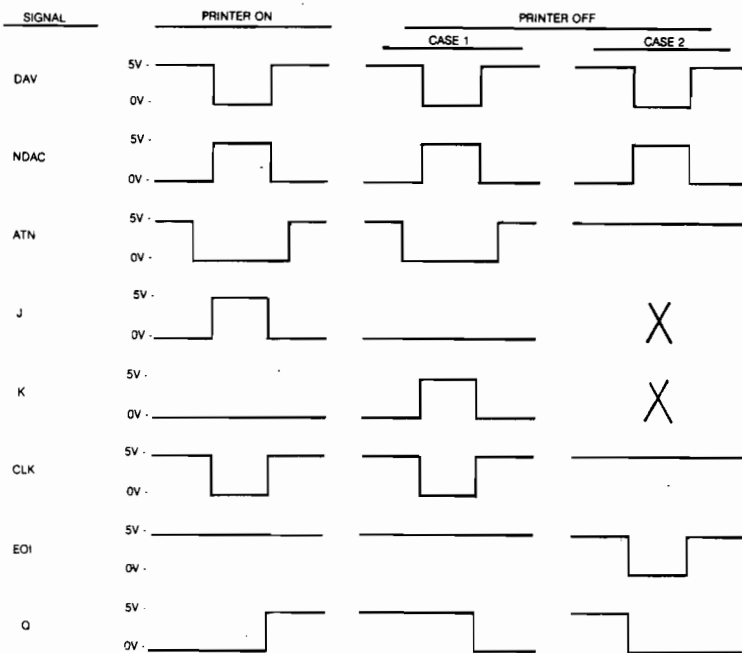

Figure 6: Timing diagram associated with the interface circuit in figure 5.



\$2x (x is device address) followed by a \$Fy (y is secondary address), and a CLOSE statement gives a \$2x followed by a \$Ey. The EOI line is brought low concurrent with the last transmitted data byte. Complete address decoding is not accomplished with the 7470 but sufficient lines are decoded to allow the interface to recognize a \$24 (printer address) and to gate the printer on (i.e., set Q high). When the last data character of a PRINT# statement is transmitted, the EOI signal gates the printer off (i.e., set Q low). Since the \$24 address code is also transmitted when an OPEN or a CLOSE statement is executed, bit 6 is used to toggle the flip-flop back low and gate the printer off once again. This is necessary in order to prevent the printer from remaining on line after an OPEN or CLOSE, which can certainly give strange behavior when communicating with a disk drive. Figure 6 illustrates the timing diagram for the interface and should make the functional operation of the interface easier to understand.

Figure 7 is a wiring layout for the printer interface. The circuit is constructed on a small piece of PC board with one side being a 24-pin edge duplicating the physical IEEE port of the PET/CBM. The other side of the interface box contains a 24-pin edge connector which plugs onto the computer IEEE port. The IEEE bus signals are passed through the box, allowing the PET-IEEE cable to be used with the interface as it was used with the computer. I used a spare 15-pin D connector for attachment to the printer. The 5-volt supply to operate the circuit was obtained from the cassette interface at the rear of the PET/CBM.

Final Comments

As I mentioned, this PET/CBM IEEE to parallel printer has worked well for me using an Integral Data System Paper Tiger with my CBM system, as well as with a PET. However, let me warn of some potential problems and limitations. First of all, the interface does not transmit the last character of the data to be printed. This is not a particularly troublesome problem if the computer transmits a carriage return and a line feed, and the printer functions with only a carriage return. The PET I have sends both a carriage return and a line feed. However, the CBM 8032 sends the line feed only if the file number is 128 or greater. This could lead to some editing of existing programs to change file numbers so that a line feed is sent. Alternatively, additional hardware could be added so that the 7470 clear

An Inexpensive Printer for Your Computer

Even the very low budget computer hobbyist can have a printer to list his programs and data. Described here is an inexpensive printer mechanism and how it works. A simple circuit and software are included that will allow this printer to be interfaced to your 6502's parallel I/O port.

Michael J. Keryan
713 Locust Drive
Tallmadge, Ohio 44278

Many computer hobbyists have no hard copy output device. The main reason is the price of printers; all but a few cost nearly as much as the computer itself. This is a shame, since much time is wasted copying programs and data back and forth from paper to keyboard, to CRT display, to paper. In this article, a printer, interface circuitry, and 6502 driver software are described. Assuming you have a microcomputer with a PIA and 768 bytes of spare memory, you can add this printer to your microcomputer for about fifty dollars.

The printer mechanism is a Sharp DC-1606A, recently offered by an electronics surplus dealer, (John Meshna Jr., of Lynn, Mass.), for \$20. The printer uses aluminized paper and gives printed copy similar to Radio Shack's \$219.00 Quick Printer II. Although not acceptable for some applications, the print is readable and useful for program and data documentation and output of programs such as checkbook balancers. The software given will print 96 characters (upper and lower case) in a five by eight matrix. The character widths are variable from five or less characters per line (for headings) to a maximum of forty-two characters per line.

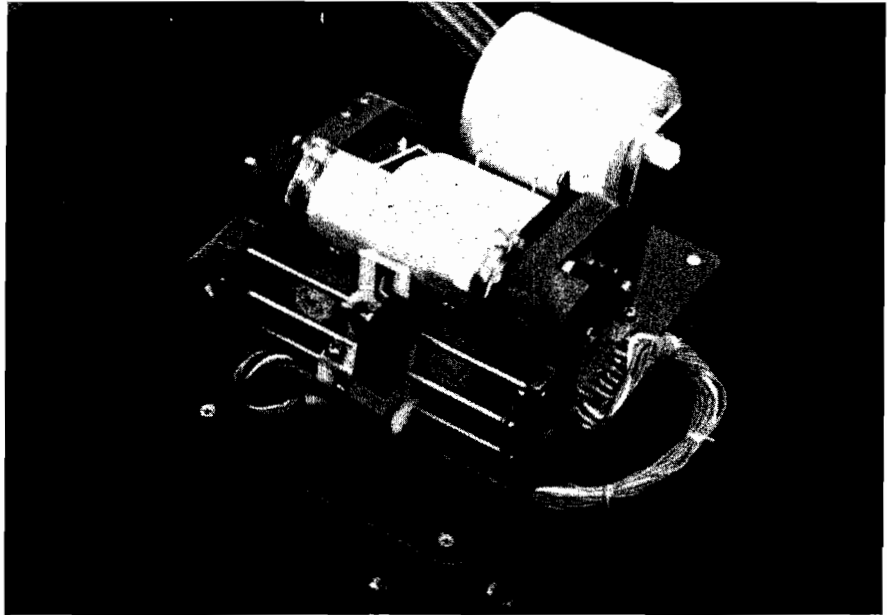

Photo 1: The printer mounted on the box containing the interface circuit and power supply.

How the Printer Works

The paper is coated with a very thin layer of aluminum, which can be burned away by electric current, leaving an almost black surface. The print head consists of a vertical column of eight elements that are in physical contact with the paper as the head traverses from left to right. If a sufficient current source is applied to the conductive aluminum surface of the paper, providing a ground through which the elements will burn away the coating, a black dot or line will be produced. Any desired character can thus be formed by turning each of the eight elements on and off at the right times.

An open loop system with character widths being a function of a timing pulse would be the simplest way to get the dots to form characters, but this is not practical. The horizontal speed of

the print head is not constant and an open loop system would give unequal character widths. However, a feedback system is extremely simple to interface, using the strobe systems in the printer mechanism. Assuming the motor is turned on and the print head is in the process of printing a line of text, the head travels from left to right across the paper. At the right margin, the print head is automatically lifted from the paper surface and the head then moves from right to left. During this motion, the platen also indexes the paper to the next horizontal line position. Therefore, carriage return and line feed occur after each line. At the left margin, the print head is lowered to the paper surface to begin the left to right scan for the next line. This is shown in figure 1.

Within the print mechanism are two strobe wheels, which can block light paths between lamps and associated

Figure 1: Motion of the print head to form a printed line with automatic carriage and line feed.

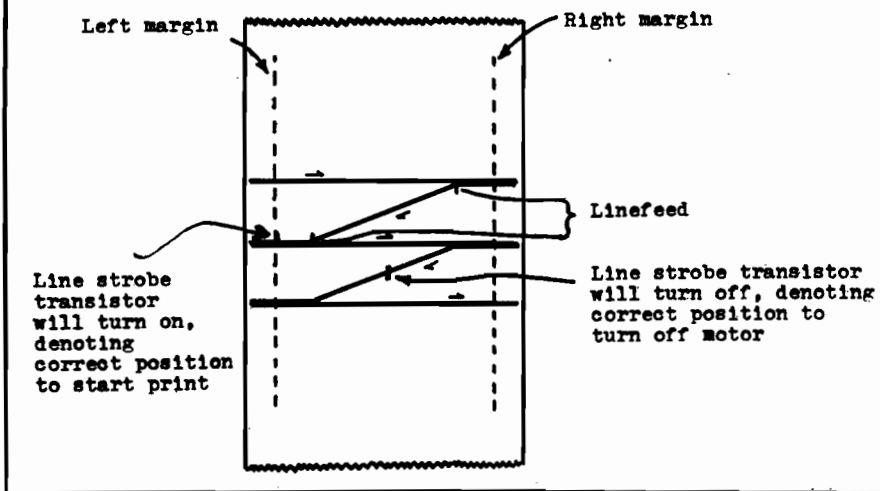

photo-transistors. The *line strobe* wheel begins to allow the light to turn on the line strobe transistor at the left margin, as the print head is moving toward the right. A transition in this transistor from off to on denotes the beginning of a line. The transistor remains on until mid-position in the carriage return. A transition of the transistor from on to off denotes the proper position to turn off the motor when printing one line. The print head will then remain in this position until another line is ready to be printed.

The *character strobe* is similar to the line strobe but contains many more hgs on a faster spinning wheel. The character strobe photo-transistor outputs a square wave of approximately 126 pulses as the print head moves to the right between margins. Although the pulse width is not constant as a function of time, it is constant as a function of movement of the print head. Therefore, turning the printhead elements on and off at the right time is merely a matter of synchronizing the output signals to the character strobes. Character widths can be varied by allowing varying integral half-cycles of the character strobe to represent a vertical column. Horizontal spacing between characters can be varied similarly. The right margin is located by counting the character strobe pulses, or alternately by counting the number of character spaces and adjusting the maximum number of characters for the pulse count per character.

Line character width will be determined by vertical column width and spacing between characters. Using five-by-eight matrices for the characters (five vertical columns, each eight segments high) and assuming that the column

widths for spacing are equal to the printed column width, the maximum number of characters per line can be represented as a function of width and spacing:

$$C = \text{INT} \frac{253 + WS}{W(5 + S)}$$

where C = number of characters/line,

W = number of half cycles of character strobe per vertical column, and

S = number of blank vertical columns after each character.

Some examples of print size are shown in table 1. In general, line lengths of from sixteen to twenty-one characters can be considered normal. Line lengths shorter than sixteen might be used for headings, while those larger than twenty-one would result in narrow, closely spaced characters, which are difficult to read without inserted spaces. The print mechanism also contains several microswitches and other features, best described in conjunction with the interface circuit.

The Interface Circuit

The interface circuitry is shown in figure 2. It can be used to interface the printer to a PIA, VIA, or TTL input/output port. (A PIA was used in the prototype.) Eight output bits are required for the print head and one output bit drives the motor control circuit. Also required are four input bits for feedback to the computer. The numbers shown at the connection points between the printer mechanism and the interface circuit refer to the numbered pins on the edge connector provided with the printer.

Table 1: Variation in print size. Listed are values of C (Number of characters/line), W (Width = number of half cycles of character strobe/vertical column), and S (Space = number of blank vertical columns following character), followed by one line of text at that spacing.

4 1 1	ABCEFGHIJKLMNOPQRSTUVWXYZ\] ^ _ ` a b c d (e f g h i j k l m n o p q r s t u v w x y z { } ~
36 1 2	ABCEFGHIJKLMNOPQRSTUVWXYZ\] ^ _ ` a b c d
32 1 3	ABCEFGHIJKLMNOPQRSTUVWXYZ\] ^ _ ` a b c d
21 2 1	ABCEFGHIJKLMNOPQRSTUVWXYZ
18 2 2	ABCEFGHIJKLMNOPQR
16 2 3	ABCEFGHIJKLMNOP
14 3 1	ABCEFGHIJKLMN
12 3 2	ABCEFGHIJKL
10 3 3	ABCEFGHIJ
10 4 1	ABCEFGHIJ
9 4 2	ABCEFGHI
8 4 3	ABCEFGH
8 5 1	ABCEFGH

As already described, a positive voltage is applied to the paper surface. A return to ground through the transistors will result in a printed dot or line. The transistors are driven by inverter sections of IC1 and IC2 (4049's). These CMOS IC's are ideal for this use since they are compatible with five volt MOS or TTL levels, and are virtually indestructible.

The positive voltage at the paper surface is sampled by two elements. When the paper runs out, the voltage at these pins will drop to zero. These pins are connected through protection and noise elimination networks to pins 11 and 12

Figure 2: Interface circuit.

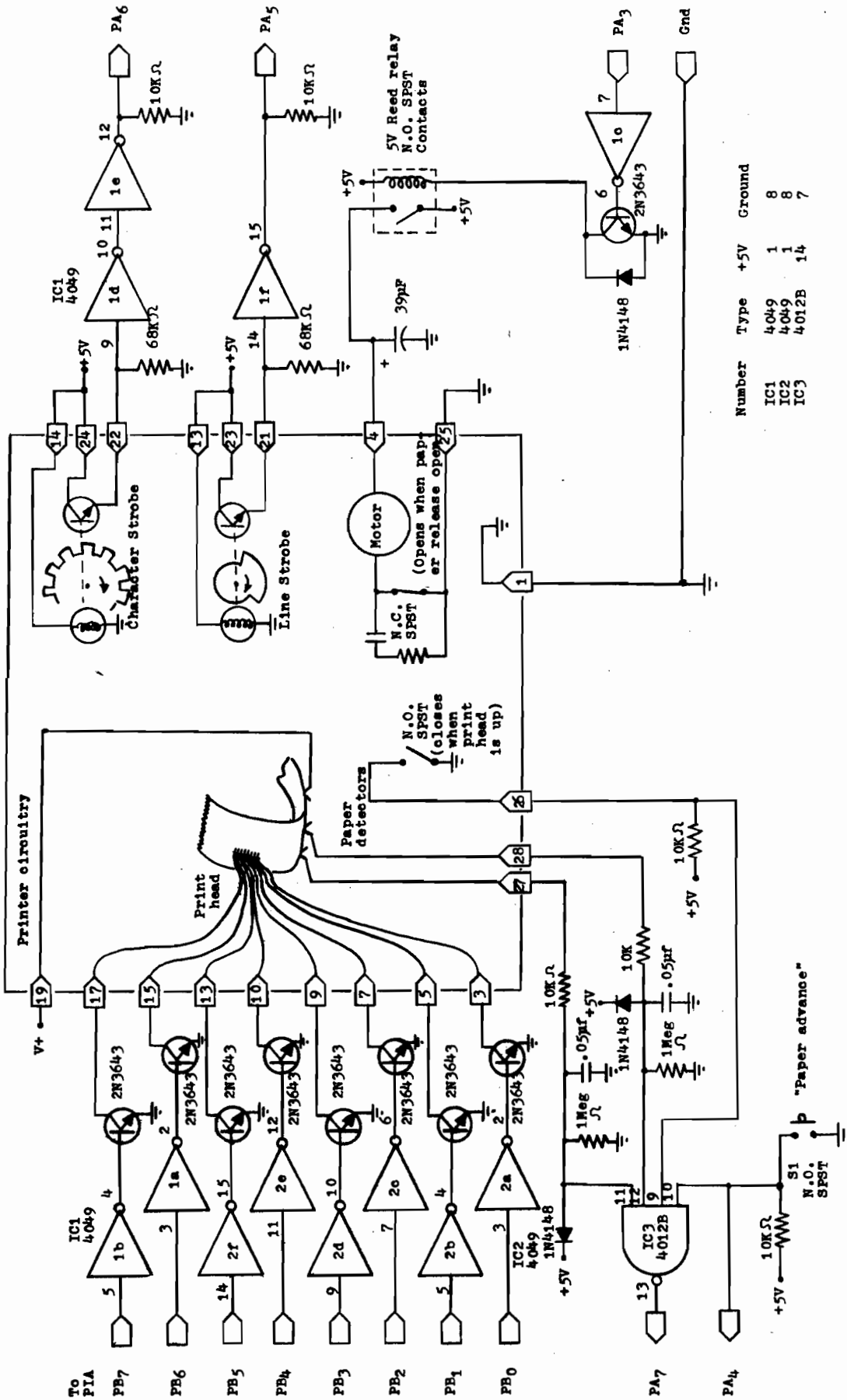

Number	Type	+5V	Ground
IC1	4049	1	8
IC2	4049	1	8
IC3	4012B	14	7

of IC3. This nand gate has two more inputs. Pin 9 is connected to a normally open switch within the printer, that closes a circuit to ground when the print head is manually lifted from the paper by sliding back the plastic guard. Pin 10 is connected to S1, a normally open SPST switch added to the interface. Zero volts on any of these inputs will cause the output of the nand gate, connected to PA7, the status bit, to go high, indicating some sort of problem. S1 is also connected, to PA4, useful as a paper advance (line feed) request.

The motor runs well at 5 volts, but not at 4.5 volts. Therefore, a reed relay is used to switch the 5 volts to the motor. An electrolytic capacitor is added to the motor connection to slightly slow down the transition from five to zero volts, removing the need for noise elimination near the cross-over point of the line strobe. PA3 drives the motor control circuit, buffered through an inverter and transistor. A zero volt level on PA3 will turn on the motor.

The lamps and the collectors of the strobe transistors are connected to the +5 volts. The emitters are brought to ground through 68Kohm resistors. The voltages generated across these resistors are buffered by CMOS inverters. The outputs of these inverters are pulled to ground through 10K resistors and are connected to PA6/PA5 for the character/line strobes, respectively. These resistors ensure the outputs to be at a zero volt level when no power is applied to the interface circuit.

The power supply, shown in figure 3, is very simple and needs little explanation. The transformer can have an output voltage of ten to thirty volts. Higher voltage will give darker print but will require a higher voltage rating for the 2000uF capacitor and more heat sinking for IC4, the voltage regulator. The prototype circuit used a twelve volt, one amp transformer.

PA0, PA1, and PA2 are not used. If desired, they could be configured for increased input/output control. One use would involve circuitry to control the power supply, by replacing S2 (the power switch) by a relay or solid-state switch.

The Software

The software shown in listing 1 was written for a 6502-based OSI C2-4P, but will require only minor modifications for other 6502 computers. A buffer area of programmable memory is required to hold one line of characters before printing. The beginning of the buffer is set to

Figure 3: Power supply for printer and interface.

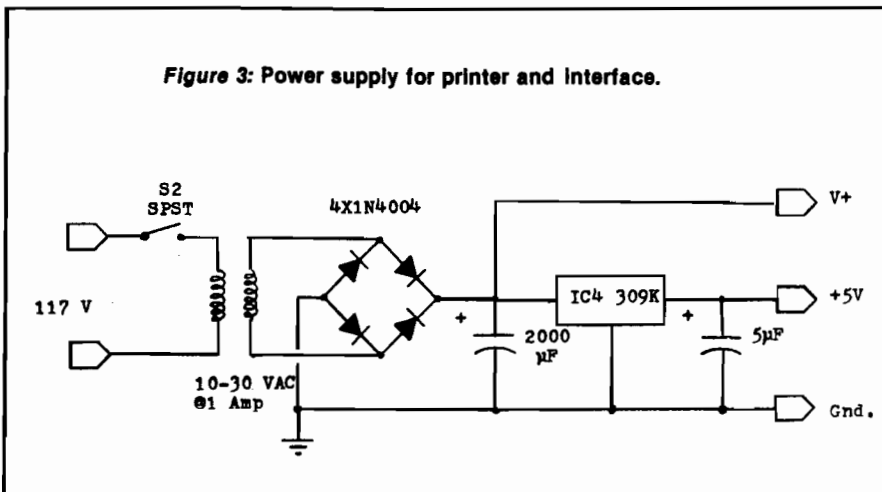

Listing 1: 6502 matrix print routine.

```

;* INEXPENSIVE PRINTER DRIVER
;*
;* BY M.J. KERZAN
;*
LINLEN EPZ $E0 ;NO. CHARACTERS/LINE
WIDTH EPZ $E1 ;NO. PULSES/COLUMN
SPACE EPZ $E2 ;BLANK COL./CHAR.
CHRCNT EPZ $E3 ;CHARACTER COUNT
STROBE EPZ $E4 ;CHAR. STROBE FLAG
TEMP EPZ $E5 ;TEMP. REGISTER
TABLEA EPZ $E6 ;COLUMN 1 VECTOR (LO,HI)
TABLEB EPZ $E8 ;COLUMN 2 VECTOR
TABLEC EPZ $EA ;COLUMN 3 VECTOR
TABLED EPZ $EC ;COLUMN 4 VECTOR
TABLEE EPZ $EE ;COLUMN 5 VECTOR
;
BUFFER EQU $D3C4 ;CHARACTER STORAGE
BUFFEND EQU $D3FF ;END OF BUFFER
;
PIADA EQU $F700 ;DATA REGISTER A
PIACA EQU $F701 ;CONTROL REGISTER A
PIADB EQU $F702 ;DATA REGISTER B
PIACB EQU $F703 ;CONTROL REGISTER B
;
ORG $8000
;
8000 48 PRINTOUT PHA ;SAVE COLUMN
8001 A5E1 LDA WIDTH ;IS WIDTH =0?
8003 F011 BEQ SUBOUT ;YES, RETURN
8005 85E5 STA TEMP ;SAVE WIDTH
8007 ADOOF7 LDA PIADA ;CHECK CHAR. STROBE
800A 2940 AND #$0100000 ;MASK
800C C5E4 CMP STROBE ;SAME?
800E F0F7 BEQ WAIT ;YES, LOOP AND WAIT
8010 85E4 STA STROBE ;NO, RESET FLAG
8012 C6E5 DEC TEMP ;WIDTH-WIDTH-1
8014 D0F1 BNE WAIT ;LOOP IF <0>
8016 68 SUBOUT PLA ;RECALL COLUMN
8017 8D02F7 STA PIADB ;OUTPUT IT
801A 60 RTS ;RETURN
801B ADOOF7 LINDET LDA PIADA ;CHECK LINE STROBE
801E 2920 AND #$00100000 ;MASK FOR LINE STROBE
8020 60 RTS ;RETURN
8021 85E5 PRINTM STA TEMP ;SAVE CHARACTER
8023 48 PRINTB PHA ;SAVE FOR RETURN
8024 8A TXA ;SAVE X REGISTER
8025 48 PHA
8026 98 TYA ;SAVE Y REGISTER
8027 48 PHA
8028 A2FF LIX #$FF
802A A900 LDA #$00
802C 8D01F7 STA PIACA ;DATA DIRECTION A
802F 8D03F7 STA PIACB ;DATA DIRECTION B
8032 85E4 STA STROBE ;INIT. STROBE FLAG
8034 A908 LDA #$00001000
8036 8D00F7 STA PIADA ;MOTOR BIT-OUT
8039 8E02F7 STX PIADB ;PRINTHEAD-OUT
803C A904 LDA #$04
803E 8D01F7 STA PIACA ;DATA REGISTER A
    
```

Listing 1 (Continued)

```

8041 8D03F7      STA PIACB      ;DATA REGISTER B
8044 8E0CF7      STX PIADA     ;MOTOR OFF
8047 8E02F7      STX PIADB     ;PRINTHEAD OFF
804A A20A        LDX #50A      ;TRANSFER TABLE
804C BDF680      TRANSF LDA ROMTAB,X ;POINTERS TO PAGE
      _STA TABLEA,X ;ZERO MEMORY
8051 CA         DEX
8052 D0F8        BNE TRANSF    ;DONE? IF SO,
8054 201B80      JSR LINDET    ;IS POWER ON?
8057 F004        BEQ OUT       ;IF NOT, RETURN
8059 A5E0        LDA LINLEN    ;O.K., IS LINLEN=0?
805B D002        BNE CHKSTP   ;NO, CONTINUE
805D F027        OUT        BEQ RETRUT   ;OTHERWISE RETURN
805F ADOCF7      CHKSTP LDA PIADA ;CHECK STATUS
8062 101A        BPL BUILD    ;IF O.K., BRANCH
8064 2910        AND #00010000 ;PAPER ADVANCE?
8066 D0F7        BNE CHKSTP   ;NO, THEN WAIT TILL O.K.
8068 A900        LDA #500
806A 8D0CF7      STA PIADA     ;TURN ON MOTOR
806D 201B80      LNFDA JSR LINDET    ;CHECK LINE STROBE
8070 D0FB        BNE LNFDA    ;WAIT IF <0
8072 201B80      LNFDB JSR LINDET    ;CHECK LINE STROBE
8075 F0FB        BEQ LNFDB    ;WAIT IF =0
8077 A908        LDA #00001000 ;LINEFEED COMPLETE,
8079 8D0CF7      STA PIADA     ;STOP MOTOR
807C D0E1        BNE CHKSTP   ;RECHECK STATUS
807E A5E5        BUILD LDA TEMP    ;GET ASCII CHAR.
8080 297F        AND #01111111 ;MASK OFF HIGH BIT
8082 C90D        CMP #50D      ;CARRIAGE RETURN?
8084 F013        BEQ FILL     ;YES, FILL BUFFER
8086 C920        RETRUT CMP #520 ;LEGITIMATE CODE?
8088 3063        BMI RETURN    ;IF NOT, RETURN
808A A6E3        LIX CHRCONT ;CURRENT BUFFER LEN.
808C 9DC4D3      STA BUFFER,X  ;ADD CHAR. TO BUFFER
808F B6E3        INC CHRCONT ;NEW BUFFER LENGTH
8091 A5E0        LDA LINLEN    ;MAXIMUM LENGTH
8093 C5E3        CMP CHRCONT ;IS BUFFER FULL?
8095 F00E        BEQ LINOUT    ;YES, OUTPUT LINE
8097 D054        BNE RETURN    ;NO, THEN RETURN
8099 A6E3        FILL  LDA CHRCONT ;CURRENT BUFFER LEN.
809B A920        LDY #520
809D 9DC4D3      LOOPFL STA BUFFER,X ;PLACE IN BUFFER
80A0 EB         INX          ;NEXT LOCATION
80A1 E4E0        CPX LINLEN    ;LAST?
80A3 D0FB        BNE LOOPFL    ;NO, CONTINUE
80A5 A200        LINOUT LDX #500 ;START LINE OUTPUT
80A7 8E0CF7      STX PIADA     ;TURN ON MOTOR
80AA A003        LDY #503
80AC 201B80      LNDT JSR LINDET    ;CHECK LINE STROBE
80AF D0FB        BNE LNDT     ;WAIT TILL=0
80B1 88         DEY          ;REPEAT 3 TIMES
80B2 D0FB        BNE LNDT     ;SO YOU ARE SURE
80B4 BCC4D3      LOOPOU LDY BUFFER,X ;GET CHARACTER
80B7 B1E6        LDA (TABLEA),Y ;COLUMN 1 CODE
80B9 200080      JSR PRTOUT    ;OUTPUT IT
80BC B1E8        LDA (TABLEB),Y ;COLUMN 2 CODE
80BE 200080      JSR PRTOUT    ;OUTPUT IT, ETC.
80C1 B1EA        LDA (TABLEC),Y
80C3 200080      JSR PRTOUT
80C6 B1EC        LDA (TABLED),Y
80C8 200080      JSR PRTOUT
80CB B1EE        LDA (TABLEE),Y
80CD 200080      JSR PRTOUT
80D0 A4E2        LDY SPACE    ;NO. OF BLANK COLUMNS
80D2 A9FF        LOOPEL LDA #5FF ;BLANK CODE
80D4 200080      JSR PRTOUT    ;OUTPUT BLANK COL.
80D7 88         DEY          ;DONE?
80D8 D0FB        BNE LOOPEL    ;NO, DO IT AGAIN
80DA EB         INX          ;NEXT CHARACTER
80DB E4E0        CPX LINLEN    ;IS THAT ALL?
80DD D0D5        BNE LOOPOUT   ;NO, LOOP & CONTINUE
80DF 201B80      CRLF JSR LINDET    ;CHECK LINE STROBE
80E2 F0FB        BEQ CRLF     ;IF =0, WAIT
80E4 A908        LDA #00001000
80E6 8D0CF7      STA PIADA     ;STOP MOTOR
80E9 A900        LDA #500
80EB 85E3        STA CHRCONT ;RESET CHAR. COUNTER
80ED 68         RETURN PLA      ;RESTORE REGISTERS
80EE A8         TAY
80EF 68         PLA
80F0 AA         TAX
80F1 68         PLA
80F2 60         RTS
80F3 EA         NOP
80F4 EA         NOP
80F5 EA         NOP
80F6
80F6 E080      ; ROMTAB ADR $B0E0 ;TABLE POINTERS WILL BE
80F8 4081      ADR $B140 ;TRANSFERRED TO PAGE ZERO
80FA A081      ADR $B1A0 ;MEMORY BY PROGRAM
80FC 0082      ADR $B200
80FE 6082      ADR $B260
8100

```

\$D3C4, which in my OSI system corresponds to the unused lower two lines of the video refresh memory. This allows the buffer to be viewed on the CRT prior to printing. Also needed are sixteen bytes of page zero programmable memory, located at hexadecimal locations 00E0-00EF, also not used by OSI routines. Three of these must be set up prior to calling the print subroutine. They can be changed between lines if desired, but must all be greater than zero:

\$00E0: (C) = number of characters/line,
 \$00E1: (W) = width of vertical column,
 \$00E2: (S) = spacing, number of blank columns/character.

Locations \$00E3-\$00E5 are temporary registers. Locations \$00E6-\$00EF are pointers to the character decoding tables. These are written from the upper ten bytes of the 256-byte program each time the program is called, so they can be used for other purposes between callings of the print subroutine. The PIA is configured at locations \$F700-\$F703, as on the OSI 500 CPU board. The program itself is located at \$8000-\$80FF, and the character decode tables start at \$8100, shown in listing 2. There are actually five of these tables, each 96 bytes long, the first table corresponding to vertical column one of ASCII characters \$20-\$7F, the second table corresponding to the second vertical column, etc. To fill out the last page, a screen clear program starts at \$82E0; this is useful only for OSI systems.

The main program is commented and therefore little explanation is necessary. There are two entry points. If the character to be printed is in the accumulator, enter the program by a JSR \$8021. If the character is not in the accumulator, it should be written into \$00E5 by either a machine language routine or a BASIC POKE statement, then the program entered by a JSR \$8023. The subroutine will restore all registers before returning. To modify the program to other 6502 configurations, only the three-byte instructions and the table pointers (upper 10 bytes) will need to be changed.

When entered, the program initializes the PIA and the strobe flag, then copies the table pointers to page zero. It then checks to see if the power to the printer is on and if the carriage is in the correct position. If not, it will then return. Next, it checks the status bit. If not OK, it will then check to see if paper advance is requested (by a closure of S1). If so, it will line feed until S1 opens. If not, it will wait until the status is OK.

The high bit of the character is then masked off and it is checked. If it is a carriage return (\$0D), the remainder of the buffer will be filled with blanks (\$20) and a line of text will be output. If the ASCII code is not legitimate (less than \$20), it will then return. Otherwise, it will add the character to the buffer and check to see if the buffer is full. If full, it will output a line; otherwise, it will return. Note that nothing is printed unless the buffer is full or the character is a carriage return.

In my system, the printer routine is called every time a character is output to the cassette tape port. This was accomplished by a jumper from the UART TDS (pin 23) to the NMI bus line. The following code is entered at the NMI vector: \$0130.

```
$0130 20 21 80 JSR $8021
$0133 40      RTI
```

For a C1P, the same thing can be accomplished by merely changing the output routine vector (located at \$021A-\$021B) to point at the following code:

```
20 21 80 JSR $8021
4C 69 FF JMP $FF69
```

The printer routine will then be executed prior to the normal output routine. In either case, a change in \$E0 from a zero to a non-zero value will enable the print routine. When in the SAVE mode, everything on the CRT will be printed. Alternately, a BASIC USR call can print selected material.

Either programmable memory or erasable read-only memory can be used for program storage, but read-only memory is much more convenient. There is an additional benefit to having the character code conversion table in memory. All your other programs can then have access to the codes, for large titles on your CRT, or whatever.

The program in listing 3, written in OSI BASIC, will demonstrate the 96 characters on the CRT display; these codes are illustrated in table 2.

Notes on Construction

The prototype was built on a small breadboard with a dual 22-pin edge connector, available at Radio Shack. After cutting a few notches on this connector, it will fit the edge connector of the printer perfectly. Since all signals are fairly low frequency, parts placement on the board is not critical. I used point-to-point wiring using pre-cut wire-wrapping wire. Use a low wattage

Listing 2: Hexadecimal character code conversion table.

	-0	-1	-2	-3	-4	-5	-6	-7	-8	-9	-A	-B	-C	-D	-E	-F
8100	FF	FF	FF	D7	DB	3B	93	FF	C7	FF	BB	EF	FF	EF	FF	FB
8110	83	FF	B9	7B	E7	1B	C3	7F	93	9D	FF	FF	EF	D7	FF	BF
8120	83	C1	01	83	01	01	01	83	01	FF	FB	01	01	01	01	83
8130	01	83	01	9B	7F	01	07	01	39	3F	79	01	BF	7D	F7	FD
8140	FF	E3	01	E3	E3	E3	FF	C7	01	FF	FF	01	FF	C1	C1	E3
8150	80	C7	C1	ED	DF	C3	CF	C3	DD	FF	DD	FF	EF	7D	F7	00
8160	FF	FF	1F	01	AB	37	6D	FF	BB	FF	D7	EF	FD	EF	FF	F7
8170	75	BD	75	7D	D7	5D	AD	71	6D	6D	FF	FD	D7	D7	7D	7F
8180	7D	B7	6D	7D	7D	6D	6F	7D	EF	7D	FD	EF	FD	BF	DF	7D
8190	6F	7D	6F	6D	7F	FD	FB	FB	D7	DF	75	01	DF	7D	EF	FD
81A0	BF	DD	EB	DD	DD	D5	EF	BA	DF	ED	FE	F7	7D	DF	DF	DD
81B0	D7	BB	EF	D5	DF	FD	F3	FD	EB	C2	D9	EF	EF	7D	EF	00
81C0	FF	05	FF	D7	01	EF	95	1F	7D	7D	01	83	F3	EF	FD	EF
81D0	6D	01	6D	6D	B7	5D	6D	6F	6D	6D	D7	D3	BB	D7	BB	65
81E0	45	77	6D	7D	7D	6D	6F	7D	EF	01	FD	D7	FD	CF	EF	7D
81F0	6F	75	67	6D	01	FD	FD	E7	EF	E1	6D	7D	EF	7D	DF	FD
8200	5F	DD	DD	DD	DD	D5	81	BA	DF	A1	FE	E7	01	E1	DF	DD
8210	BB	BB	DF	D5	81	FD	FD	FB	F7	FA	D5	93	AB	93	EF	00
8220	FF	FF	1F	01	AB	D9	FB	FF	FF	BB	D7	EF	FF	EF	FF	DF
8230	5D	FD	6D	4D	01	5D	6D	5F	6D	6B	FF	FF	7D	D7	D7	5F
8240	65	B7	6D	7D	7D	6D	6F	75	EF	7D	FD	BB	FD	BF	F7	7D
8250	6F	7B	6B	6D	7F	FD	FB	FB	D7	DF	5D	7D	F7	01	EF	FD
8260	BF	EB	DD	DD	EB	D5	6F	D6	DF	FD	A1	DB	FD	DF	DF	DD
8270	BB	D7	DF	D5	DF	FD	F3	FD	EB	FA	CD	7D	EF	EF	EF	00
8280	FF	FF	FF	D7	B7	B9	F5	FF	FF	C7	BB	EF	FF	EF	FF	BF
8290	83	FF	9D	33	F7	63	73	3F	93	87	FF	FF	FF	D7	EF	BF
82A0	8D	C1	93	BB	83	7D	7F	71	01	FF	03	7D	FD	01	01	83
82B0	9F	85	9D	B3	7F	01	07	01	39	3F	3D	7D	FB	01	F7	FD
82C0	FF	C1	E3	DD	01	E7	FF	81	E1	FF	FF	BD	FF	E1	E1	E3
82D0	C7	80	FF	DB	DF	C1	CF	C3	DD	C1	DD	7D	EF	FF	DF	00
82E0	48	98	48	A0	00	A9	20	99	00	D3	99	00	D2	99	00	D1
82F0	99	00	D0	C8	D0	F1	68	A8	68	60	4B	65	72	79	61	6E

Listing 3: Character demonstration program in BASIC.

```
10 REM CHARACTER
15 REM DEMO
20 REM BY M.J. KERYAN
25 :
30 IS = 53612: REM CORNER
35 TA = 32992: REM TABLE-32
40 CU = 54116: REM CURS LOC
45 B1 = 32:B2 = 127
50 FOR C = IS - 66 TO IS - 58
55 POKE C,B2: POKE C + 32,B1
60 POKE C + 320,B1: POKE C + 352 ,B2
65 NEXT : POKE IS - 34,B2: POKE IS - 26,B2
70 FOR C = IS - 2 TO IS + 224 STEP 32
75 POKE C,B2: POKE C + 1,B1
80 POKE C + 7,B1: POKE C + 8,B2
85 NEXT : POKE IS + 254,B2: POKE IS + 262,B2
90 FOR CR = 32 TO 127
95 POKE CU,CR
```

(Continued)

soldering iron and sockets for the CMOS IC's. None of the resistor or capacitor values is very critical. All transistors should be high gain, high current types, such as 2N3643, 2N4401, etc. The unused input pins of IC3 should be brought to either 5 volts or ground.

The circuit board, switches, and transformer were mounted in a Radio Shack plastic box (item #270-224). The printer was mounted on top, using rubber stand-offs. The paper holder was made from a piece of aluminum formed into a U-shape. A cut-down toilet tissue holder was mounted on the support. Before connecting the interface to the printer, the interface should be powered up and checked out by bringing all inputs to 5 volts or ground, and monitoring the corresponding outputs. Then connect the printer, turn it on, and check out the motor by switching the line marked PA3 to ground.

Comments on Use

If out of paper, pull the plastic guard up and lock the metal lever up to loosen the platen. Feed the end of a new roll from the back, release the metal lever to tighten the platen against the paper, and close S1. The paper will then advance as long as S1 is closed. After opening S1, flip the plastic guard back into position and the printer will continue normal operation.

The printer should only be turned on after the computer is powered up. Likewise, the printer should be turned off before the computer. Failure to follow this sequence will turn on the motor, due to a low voltage at PA3. The reason for this configuration is that before the PIA is initialized, all outputs will be high.

When printing tables, it is sometime advantageous to change the spacing parameters between lines. This was done in table 2, in which three different configurations were used.

Michael Keryan has a Master of Science degree in Chemical Engineering, and has used computers in school, and for the last eleven years in industrial applications. His hobby has been electronics and, most recently, microcomputers; his interests are equally divided between hardware, software, and systems. To keep the cost of his hobby within reason, he prefers to build everything himself. This article is the result of one such project.

Listing 3 (Continued)

```

100 GOSUB 125
105 FOR DE = 1 TO 250: NEXT DE
110 NEXT CR
115 END
120 : REM SUBROUTINE
125 : REM PLOTS CHAR'S
130 FOR J = 0 TO 4
135 JN = J * 96
140 X = PEEK (CR + TA + JN)
145 FOR N = 7 TO 0 STEP - 1
150 P = 2 ^ N
155 L = IS + J + 32 * (7 - N)
160 IF (X AND P) > .5 THEN POKE L,B1: GOTO 170
165 POKE L,B2
170 NEXT N
175 NEXT J
180 RETURN
    
```

Table 2: Character set. The tables in listing 2 define 96 characters. These are the standard ASCII symbol, upper case, and lower case characters, except for a degree symbol (for hexadecimal 60) and a divide symbol (for hexadecimal 7C).

HEX-ASCII TABLE

X	2X	3X	4X	5X	6X	7X
0	0	@	P	*	p	
1	!	1	A	Q	a	q
2	"	2	B	R	b	r
3	#	3	C	S	c	s
4	\$	4	D	T	d	t
5	%	5	E	U	e	u
6	&	6	F	V	f	v
7	'	7	G	W	g	w
8	<	8	H	X	h	x
9	>	9	I	Y	i	y
A	*	:	J	Z	j	z
B	+	;	K	[k	[
C	,	<	L	\	l	\
D	-	=	M]	m]
E	.	>	N	^	n	^
F	/	?	O	_	o	_

The MICRO Software Catalog (pages 104, 105) presents a listing of unique software that is available through a wide network of vendors. These announcements are run free of charge, but limited to only one per company, each month.

If you have a software package you'd like to announce to MICRO's readers, send for an application form. Complete details will be provided.

Software Catalog
 34 Chelmsford Street
 P.O. Box 6502
 Chelmsford, MA
 01824

**NIKROM TECHNICAL PRODUCTS PRESENTS
A DIAGNOSTIC PACKAGE FOR THE APPLE II
AND APPLE II + COMPUTER.
"THE BRAIN SURGEON"**

Apple Computer Co. has provided you with the best equipment available to date. The Diagnostic's Package was designed to check every major area of your computer, detect errors, and report any malfunctions. *The Brain Surgeon* will put your system through exhaustive, thorough procedures, testing and reporting all findings.

The Tests Include:

- MOTHERBOARD ROM TEST
- APPLESOFT ROM CARD TEST
- INTEGER ROM CARD TEST
- MOTHERBOARD RAM TESTS
- DISK DRIVE SPEED CALIBRATION
- DISK DRIVE MAINTENANCE
- DC HAYES MICROMODEM II TEST (HARDWARE & EPROM)
- MONITOR & MODULATOR ROUTINES
- MONITOR SKEWING TESTS
- MONITOR TEST PATTERN
- MONITOR TEXT PAGE TEST
- MONITOR & TV YOKE ALIGNMENT
- LO-RES COLOR TESTS
- HI-RES COLOR TESTS
- RANDOM HI-RES GENERATOR
- SPEAKER FUNCTION TESTS
- SQUARE WAVE MODULATION
- PADDLE & SPEAKER TEST
- PADDLE & BUTTON TEST
- PADDLE STABILITY
- INTERNAL MAINTENANCE
- GENERAL MAINTENANCE
- ON BOARD "HELP"

NEW!

The Brain Surgeon allows you to be confident of your system. This is as critical as the operating system itself. You *must* depend on your computer 100% of it's running time. *The Brain Surgeon* will monitor and help maintain absolute peak performance.

Supplied on diskette with complete documentation and maintenance guide.

PRICE: \$49.95
REQUIRES: 48K, FP in ROM
1 Disk Drive, DOS 3.2 or 3.3

Nikrom Technical Products
25 PROSPECT STREET • LEOMINSTER, MA 01453

Order Toll-Free Anytime
Master Charge & VISA users call: 1-800-835-2246
Kansas Residents call: 1-800-362-2421

Dealer Inquiries Invited

APPLE II Registered
Trademark of Apple Computer Co.
MICROMODEM II is Registered
Trademark of D.C. HAYES

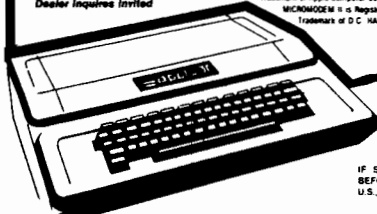

IF SERIAL NUMBER IS BELOW 20,000 OR DATED BEFORE 2/15/81, THEN RETURN DISKETTE PLUS \$7.00 U.S. \$8.00 FOREIGN.

**THE ultimate in SPEED and
language POWER for the APPLE II:**

THE INTEGER BASIC COMPILER

- SPEED IMPROVEMENT BY A FACTOR OF 10 TO 20 OVER APPLE'S BASIC INTERPRETER - 15 TO 30 OVER APPLESOFT!
- NO LANGUAGE CARD NECESSARY!
- OPTIMIZE CODE FOR YOUR SPEED/SPACE REQUIREMENTS.
- OBJECT CODE AND RUN-TIME SYSTEM ARE COMPLETELY RELOCATABLE - USE MEMORY THE WAY YOU WANT TO!
- MANY POWERFUL BASIC LANGUAGE EXTENSIONS:
 - FULL STRING LENGTH OF 32767 - NO 255 LIMIT!
 - CHR\$, GET AND KEY FUNCTIONS.
 - DIRECT HI-RES GRAPHICS SUPPORT.
 - HOME, INVERT, NORMAL, FLASH, AND MORE!
- MANY APPLICATIONS - EXISTING INTEGER PROGRAMS CAN BE EASILY CONVERTED TO RUN ON ANY APPLE II!
- COMPILER REQUIRES: APPLE II (OR II PLUS WITH INTEGER OR LANGUAGE CARD), 48 K AND DOS 3.3.
- SUPPLIED ON 2 DISKS WITH COMPLETE DOCUMENTATION.

PRICE: \$ 149.50

Dealer Inquiries invited.

(Calif. add 6.5% sales tax, Foreign add \$5.00 air mail)

GALFO SYSTEMS 6252 CAMINO VERDE
SAN JOSE, CA 95119

* Apple, Applesoft - Trademarks of Apple Computer Co.

**The ultimate APPLE® copy program
COPY II PLUS
\$39⁹⁵**

VERSATILE — Copy II Plus copies multiple formats — DOS 3.2, 3.3, PASCAL, FORTRAN, and CPM.

FAST — Copy II Plus copies diskettes in less than 45 seconds. That's faster than most other copy programs. Written entirely in ultra fast assembly language.

Search no more for that truly versatile, fast copy program. Copy II Plus is the most advanced copy program available for the Apple II Computer. Compare capability, compare speed, compare price, then call or write to order Copy II Plus. Requires Apple II with 48K and at least one Disk Drive.

**CENTRAL POINT
Software, Inc.**

**P.O. Box 3563
Central Point, OR 97502
(503) 773-1970**



or check

Deliveries from stock. No C.O.D.'s
Apple is a registered trademark of Apple Computer, Inc.

WORD-CHECK

WORDCHECK is a poor spellers dream come true. Designed to interact with WORDPRO, it has 2100 root words and suffixes. In addition for the business and scientific user it has the capacity for 900 industrial or scientific terms which you load in yourself. You have a total vocabulary of approximately 7500 words at your fingertips. It simply goes through the text and flags any words that it doesn't recognize.

WORDCHECK is the ideal program to proof your spelling, whether it is one paragraph or a 100 page manual. The dictionary is versatile, allowing the user to add or delete words. You can design the program with the technical terms your profession uses, even duplicating the table and tailoring it for each person in your office. Let WORDCHECK do the work for you quickly and accurately.

CREATE-A-BASE

CREATE-A-BASE is a data base file management system that enables the user to choose the number of fields needed in a file, and add or delete fields without disturbing any of the existing data. Once a file is created you can perform any of 30 functions. Such as:

- Interact with WORDPRO 4, and 4 +
- Do mathematic functions on any 2 or more fields
- Sort 650 files in only 19 seconds
- Merge any sequential file into a **CREATE-A-BASE** file, and output a sequential file from a **CREATE-A-BASE** file.
- The report generator has the feature of user defined fields and field width.
- Printouts can be generated by values such as, greater than, less than, equal to or in alpha or numeric codes.

You don't have to be a programmer to operate **CREATE-A-BASE** on your COMMODORE computer. It's menu driven and asks you questions at each step as you perform any of its many functions.

AVAILABLE

at your local COMMODORE dealer or distributed exclusively in CANADA by
B.P.I. Micro Systems, Ltd.
80 Barbados Blvd. #14
Scarborough, Ontario M1J1K9

Special Dealer Introductory Package Available

Micro Computer Industries Ltd.

1520 E. Mulberry, Suite 170 Fort Collins, CO 80524

1-303-221-1955

Expressions Revealed,

Part 2

In this, the final part of the series, the author presents and discusses BASIC and Pascal versions of a program demonstrating the translation process.

Richard C. Vile, Jr.
3467 Yellowstone Dr.
Ann Arbor, Michigan 48105

Expression Translation Implemented

Listings 1 and 2 present two demonstration programs, both of which implement the infix to postfix translation algorithm. They allow the user to view the process as it is carried out, by displaying various information used by the algorithm on the Apple II screen. The program in listing 1 is written in Integer BASIC, while that in listing 2 is written in Pascal. We shall conclude the article with a few comparisons between the implementations and an elucidation of the operation of the demonstrations.

The demonstration programs expect a partially parenthesized expression as input. The allowable operators in the expression are as follows:

& ! ' = # < > + - * / ↑

where the logical operators AND, OR, and NOT have been replaced by the single characters &, !, and ', respectively. This makes the operation of the scanner much simpler and removes detail from our discussion that is not strictly relevant to the translation algorithm.

The translation algorithm discussed last month in part 1 is executed directly upon the screen. As each character is scanned, it is highlighted in reverse video. (Note: if your Apple II has been modified to display lower case, this probably will not work.) The output string, which is the RPN translation of

Figure 1: Subroutine Hierarchy of Listing 2.

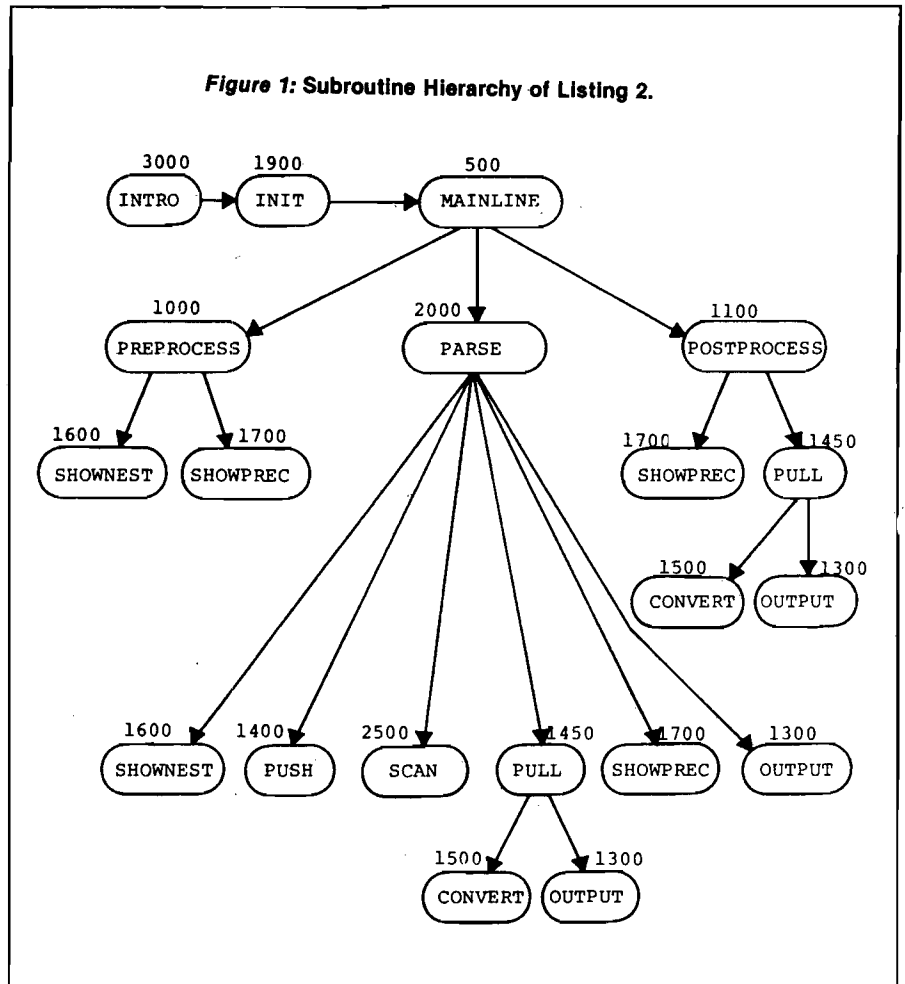

the original expression, grows dynamically on a separate line as the scan progresses, and the stack of operators grows and shrinks on yet another line. In addition, other information is displayed on the lower portion of the screen:

```

NESTING LEVEL = = = = = >
CURRENT PRECEDENCE = = = >
LAST PRECEDENCE = = = = = >
TOKEN = = = = = = = = = >
STACK DEPTH = = = = = = = >
  
```

Each piece of information so displayed is updated on the screen whenever it is modified by any portion of the translation algorithm. As the translation proceeds, there are pauses to allow the viewer to absorb the significance of the translation of the changes that have taken place. To cause the translation to continue after one of these pauses, simply press any key on the Apple II keyboard. A more detailed version of the demonstration in which the routines of the translation algorithm "talk" to the user, i.e. print explanations of their operation, is available from the author (see note at end of the article).

Figure 1 shows the calling hierarchy of the routines used in the BASIC implementation of the translation algorithm (see listing 1). It is suggested that the user study the Pascal implementation given in listing 2 and construct a similar diagram. This will give an opportunity to compare the inner details of the two implementations.

Some Comparisons

There are some noteworthy points concerning the style of the two programs presented in listings 1 and 2 which bear directly on the differences between the two languages BASIC and Pascal. The following discussion is not intended to be complete, but rather to prompt the reader into further thoughts and investigations along the same lines.

Length: The Pascal version is longer than the BASIC version, at least in pages of text (I did not count individual characters). There are several reasons for this: Pascal encourages and indeed requires the programmer to provide more information about the program, and Pascal is much easier to read if it is written in a "spread out" fashion. Even though the following code would be "legal":

```
IF TOKEN = OPERAND THEN
  RPNOUT(NEXTCHAR) ELSE IF
  TOKEN = LPAREN THEN BEGIN
  NEST := NEST + 1; GOTOXY
  (25,NESTLINE); SCREEN(CLREOL);
  WRITE(NEST); END ELSE IF
  TOKEN = RPAREN THEN BEGIN
  NEST := NEST - 1; GOTOXY
  (25,NESTLINE); SCREEN(CLREOL);
  WRITE(NEST); END ELSE BEGIN
  NOWP := NEST*10 +
  PRECEDENCE[TOKEN]; SHOW
  PRECEDENCE; POPSTACK(NOWP);
  PUSHSTACK(TOKEN,NOWP); END;
```

it is extremely difficult to read and would be considered poor Pascal style. See listing 2 for the "acceptable" version of the same code (in PROCEDURE PARSE). What is the underlying reason for this? In Pascal, statements may continue on for many lines. This example is actually *one* Pascal IF statement. In BASIC this is not the case; statements are limited to a single line. The consequence is that you don't have to be as careful when formatting your BASIC source programs as you do when formatting your Pascal programs.

The practical consequences of the differences in length seem to be:

1. Pascal programs tend to be easier to read, understand and modify, but they are more difficult in some ways to write.
2. BASIC programs, especially shorter ones, tend to be easier to write than the corresponding Pascal programs. They are more difficult to read, understand, and modify, especially as they become longer.

Structure: The Pascal language provides many more structuring facilities than does the BASIC language. This applies not only to the procedural portion of programs in which Pascal provides:

```
named procedures with parameters
if-then-else statement
while-do statement
repeat-until statement
for statement
```

but also in the *declarative* portion of programs in which Pascal provides explicit structuring mechanisms to reveal the logical relationships between various pieces of data used. Pascal gives us not only variables and arrays, but also:

```
sets
records
pointers
```

as well as the ability to *nest* instances of these facilities, one within the other. This leads to a notational clarity in the *representation* of data, especially data that possesses some inherent structure. In the demonstration programs, the operator stack provides a simple example. In the BASIC version, the stack of composite items of information must be represented using separate arrays which are maintained in "parallel." The value of the top of stack is kept in yet another variable. In the Pascal implementation, the operator stack is considered to be a single entity. The structure of this entity is declared in the *type* section of the program:

TYPE

```
STACK = RECORD
  TOS: INTEGER;
  OPS: ARRAY[0..40] OF RECORD
    OPR: OPERATOR;
    PREC: INTEGER;
  END;
END;
```

The stack is incarnated in the *var* section of the program:

VAR

```
OPSTACK: STACK;
```

The OPSTACK is a *single variable* whose structure is indicated by its type, namely STACK. The various parts of the stack may only be accessed by mentioning the name of the operator stack, OPSTACK first. For example,

```
OPSTACK.TOS
OPSTACK.OPS[I].PREC
OPSTACK.OPS[OPSTACK.TOS].OPR
```

and so on. To the long-time BASIC user, this seems like wasteful nomenclature, but it serves at least two important functions:

1. It documents the use of the data in the program for the future reader of the program. This documentation is directly a part of the code itself and is "forced" on the programmer.
2. It forces the programmer to write in more detail, thus preventing, in many cases, inadvertent modification of variables, which could lead to subtle bugs. This is much more important in larger programs, especially in those in which *many* variables may have identical structure. In such cases, the use of parallel arrays requires the invention of different *names* for the pieces of each individual variable. This proliferation of names can easily tax the memory of the best programmer.

Game, anyone?

In the past we have rejected almost all game articles that have been submitted to MICRO. Our November issue, however, will include a special games bonus. If you have written an article about an original game, we'd like to review it. Please send the article, along with a tape or disk, if possible, to:

MICRO, Editorial Dept.
34 Chelmsford Street
P.O. Box 6502
Chelmsford, MA 01824

Listing 1

```

10 DIM LINE$(250)
11 DIM STACK(25)
12 DIM PRECEDENCE(25)
20 CLREOL=-968:KBD=-16384:CLR=
  -16368:HOME=-936
25 INIT=1900:PREPROCESS=1000
26 POSTPROCESS=1100
27 INTRO=3000
28 SCAN=2500:PARSE=2000
29 ERRLINE=22:WAIT=1200
30 OUTPUT=1300:OLINE=6
31 PUSH=1400:PULL=1450
32 STKLINE=10:NESTLINE=12:NOWPLINE=
  13
33 CONVERT=1500:LASTPLINE=14:TOKENL
  INE=15:TOSLINE=16
34 SHOWNEST=1600:SHOWPREC=1700

400 REM SET UP FOR A RUN
401 REM =====
405 CALL HOME
410 GOSUB INTRO: CALL HOME
415 GOSUB INIT: REM SET UP SCREEN
500 REM MAINLINE DRIVER
501 REM =====
505 VTAB 1: TAB 1: POKE 50,63
506 PRINT "INPUT EXPRESSION TO BE PA
  RSED"
507 CALL CLREOL
508 POKE 50,255
509 PRINT "===> ";
510 INPUT LINE$:L= LEN(LINE$)
512 IF L#0 THEN 515: TEXT : CALL
  HOME: END
515 GOSUB PREPROCESS
520 FOR CI=1 TO L
525 CH$=LINE$(CI,CI)
530 POKE 50,63: VTAB 2: TAB CI+
  6: PRINT CH$: POKE 50,255
535 IF CH$# " " THEN GOSUB PARSE
540 IF TOKEN#255 THEN 550
542 REM BAD TOKEN FOUND - ABORT
543 REM =====
545 VTAB ERRLINE: TAB 5: PRINT
  "ILLEGAL INPUT"
546 GOSUB WAIT: GOTO 505
550 REM TOKEN WAS OK
555 REM CHECK NESTING OK
556 REM =====
560 IF NEST>=0 THEN 575
565 VTAB ERRLINE: TAB 1: PRINT
  "TOO MANY RIGHT PARENTHESES"

566 GOSUB WAIT: GOTO 505
575 GOSUB WAIT
577 VTAB 2: TAB CI+6: PRINT CH$
  ;
580 NEXT CI
590 GOSUB POSTPROCESS
599 GOTO 505
1000 REM PREPROCESS THE INPUT
1001 REM
1002 REM INCLUDES INITIALIZATIONS
1003 REM REPEATED BEFORE EACH PARSE
1004 REM =====
1005 NOWP=-1:LASTP=-1:NEST=0
1006 TOS=0: REM STACK POINTER
1010 OI=1: REM OUTPUT INDEX
1015 VTAB OLINE: TAB 5: CALL CLREOL:
  CALL CLREOL
1020 GOSUB SHOWNEST: GOSUB SHOWPREC
1099 RETURN
1100 REM POSTPROCESS THE INPUT
1101 REM =====
1105 NOWP=-1: GOSUB SHOWPREC
1110 IF NEST=0 THEN 1120
1115 VTAB ERRLINE: TAB 1: PRINT
  "NOT ENOUGH RIGHT PARENTHESES"

```

```

1120 IF TOS=0 THEN 1199
1125 GOSUB PULL
1190 GOSUB WAIT
1199 RETURN
1200 REM WAIT ROUTINE
1201 REM =====
1205 POKE CLR,0
1210 POKE 50,63: VTAB 24: TAB 5
1212 PRINT "PRESS ANY KEY TO CONTINUE
  ";
1213 POKE 50,255
1215 IF PEEK (KBD)<128 THEN 1215

1220 POKE CLR,0
1225 VTAB ERRLINE: TAB 1: CALL CLREOL

1226 VTAB 24: CALL CLREOL
1249 RETURN
1300 REM DISPLAY OUTPUT TOKEN AT
1301 REM APPROPRIATE POSITION ON
1302 REM THE SCREEN.
1303 REM =====
1305 VTAB OLINE: TAB OI+6: PRINT
  CH$;
1310 OI=OI+1
1349 RETURN
1400 REM PUSH OPERATOR TOKEN ON THE
1401 REM STACK. DISPLAY THIS ON
1402 REM THE SCREEN.
1403 REM =====
1405 TOS=TOS+1
1410 STACK(TOS)=ASC(CH$)
1415 VTAB STKLINE: TAB TOS+4: PRINT
  CH$;
1420 PRECEDENCE(TOS)=NOWP
1425 VTAB TOSLINE: TAB 25: CALL
  CLREOL: PRINT TOS
1449 RETURN
1450 REM POP OPERATOR TOKEN FROM THE
1451 REM STACK TO THE OUTPUT. THE
1452 REM SCREEN IS UPDATED TO SHOW
1453 REM THIS TRANSFORMATION.
1454 REM =====
1455 IF NOWP>=PRECEDENCE(TOS) THEN
  RETURN
1460 OPR=STACK(TOS)
1465 TOS=TOS-1: IF TOS<0 THEN TOKEN=
  255
1470 VTAB STKLINE: TAB TOS+5: PRINT
  " ";
1475 GOSUB CONVERT:CH$=CHR$: GOSUB
  OUTPUT
1477 VTAB TOSLINE: TAB 25: CALL
  CLREOL: PRINT TOS
1480 VTAB LASTPLINE: TAB 25: CALL
  CLREOL: PRINT PRECEDENCE(TOS)

1485 GOTO 1455
1499 RETURN
1500 REM CONVERT NUM TO CHARACTER
1501 REM INTEGER BASIC CHR$ FUNCTION
1502 REM IN USER CONTRIBUTED SOFT-
1503 REM WARE.
1504 REM =====
1505 CHR=OPR
1510 CHS=CHR+128*(CHR<128)
1515 LC1= PEEK (224):LC2= PEEK (
  225)-(LC1>243): POKE 79+LC1-
  256*(LC2>127)+(LC2-255*(LC2>
  127))*256,CHS:CHR$="<": RETURN

1600 REM DISPLAY NESTING LEVEL
1601 REM =====
1605 VTAB NESTLINE: TAB 25: CALL
  CLREOL: PRINT NEST
1649 RETURN
1700 REM DISPLAY CURRENT PRECEDENCE
1701 REM AND TOP OF STACK PRECEDENCE

```

(Continued)

```

1702 REM =====
1705 VTAB NOWLINE: TAB 25: CALL
CLREOL: PRINT NOWP
1710 VTAB LASTLINE: TAB 25: CALL
CLREOL: PRINT PRECEDENCE(TOS)

1749 RETURN
1900 REM ONE TIME INITIALIZATIONS
1901 REM THIS INCLUDES PRINTING
1902 REM THE SCREEN LAYOUT.
1903 REM =====
1910 PRECEDENCE(0)=-2: REM NEEDED IN
ORDER TO STOP POSTPROCESSING
1950 VTAB 4: PRINT "*****"
*****";
1952 POKE 50,63: PRINT "OUTPUT":
POKE 50,255
1954 PRINT "====>"
1956 VTAB 8: PRINT "*****"
*****";
1958 POKE 50,63: PRINT "STACK": POKE
50,255
1960 PRINT "====>"
1962 VTAB 12: POKE 50,63: PRINT
"NESTING LEVEL=====>": CALL
CLREOL
1963 PRINT "CURRENT PRECEDENCE====>"
: CALL CLREOL
1965 PRINT "LAST PRECEDENCE=====>"
: CALL CLREOL
1966 PRINT "TOKEN=====>"
: CALL CLREOL
1967 PRINT "STACK DEPTH=====>"
: CALL CLREOL
1969 POKE 50,255
1970 PRINT : PRINT " PRECEDE
NCE IS CALCULATED BY:"
1972 PRINT : TAB 2: PRINT "PRECEDENCE
=(NESTING LEVEL*10)+TOKEN"
1999 RETURN
2000 REM EXECUTE PARSE MACHINE
2001 REM ACTIONS - CONVERT TO
2002 REM REVERSE POLISH NOTATION
2003 REM =====
2005 GOSUB SCAN: REM CONVERT CHAR TO
TOKEN
2007 T#=CH#: REM SAVE IN CASE OF PUL
L
2008 VTAB TOKENLINE: TAB 25: CALL
CLREOL: PRINT TOKEN
2010 REM THE "PARSE MACHINE" TAKES
2011 REM ACTIONS BASED ON THE VALUE
2012 REM OF THE CURRENT TOKEN.
2013 REM =====
2020 IF TOKEN#-1 THEN 2030
2025 NEST=NEST+1: GOSUB SHOWNEST
2027 RETURN
2030 IF TOKEN#-2 THEN 2040
2035 NEST=NEST-1: GOSUB SHOWNEST
2037 RETURN
2040 IF TOKEN#0 THEN 2050
2045 GOSUB OUTPUT: RETURN
2050 IF TOKEN=255 THEN RETURN
2055 NOWP=NEST*10+TOKEN: GOSUB SHOWPR
EC
2060 GOSUB PULL
2062 CH#=T#: REM RESTORE AFTER POSSI
BLE PULL
2065 GOSUB .PUSH
2070 LASTP=NOWP
2099 RETURN
2500 REM DETERMINE NEXT TOKEN
2501 REM CONVERT CH# TO INTERNAL
2502 REM FORM. VALUES ARE:
2503 REM
2504 REM OPERAND- 0
2505 REM NOT - 1 (')
2506 REM AND/OR - 2 (&!)
2507 REM RELOP - 3 (#,<,>)
2508 REM ADDOP - 4 (+,-)
2509 REM MULOP - 5 (*,/)
```

```

2510 REM EXPOP - 6 (†)
2511 REM LPAREN - -1 '('
2512 REM RPAREN - -2 ')'
2513 REM
2514 REM =====
2520 IF ( ASC(CH#)< ASC("A")) OR
( ASC(CH#)> ASC("Z")) THEN
2525
2522 TOKEN=0: RETURN
2525 IF ( ASC(CH#)< ASC("0")) OR
( ASC(CH#)> ASC("9")) THEN
2530
2527 TOKEN=0: RETURN
2530 IF CH#="(" THEN 2540
2535 TOKEN=-1: RETURN
2540 IF CH#=")" THEN 2550
2545 TOKEN=-2: RETURN
2550 IF CH#="/" THEN 2560
2555 TOKEN=1: RETURN
2560 IF (CH#="&" AND CH#="!") THEN
2570
2565 TOKEN=2: RETURN
2570 IF (CH#="#" AND CH#="#" AND
CH##"<" AND CH##">") THEN 2580

2575 TOKEN=3: RETURN
2580 IF (CH#="#" AND CH##" -") THEN
2590
2585 TOKEN=4: RETURN
2590 IF (CH##"*" AND CH##" /") THEN
2600
2595 TOKEN=5: RETURN
2600 IF CH##"†" THEN 2610
2605 TOKEN=6: RETURN
2610 TOKEN=255: RETURN : REM ERROR T
OKEN
3000 REM INTRODUCTION TO PROGRAM
3001 REM =====
3005 VTAB 1: TAB 1
3009 POKE 50,63
3010 PRINT " DEMONSTRATION OF EXPRES
SION PARSING."
3011 POKE 50,255: PRINT
3012 PRINT "THIS PROGRAM CONVERTS INF
IX NOTATION"
3014 PRINT "EXPRESSIONS TO REVERSE PO
LISH NOTATION:"
3015 PRINT "ALSO KNOWN AS 'POSTFIX' N
OTATION."
3018 PRINT
3020 PRINT " THE INPUT EXPRESSION IS
SCANNED FROM"
3022 PRINT "LEFT TO RIGHT. OPERANDS,
IN THIS DEMO"
3024 PRINT "REPRESENTED BY SINGLE LET
TERS OR DIGITS,;"
3026 PRINT "ARE OUTPUT WHEN ENCOUNTER
ED. OPERATORS"
3028 PRINT "ON THE OTHER HAND ARE STA
CKED WHEN FIRST";
3030 PRINT "SCANNED. THE TOP OF THE
STACK IS SENT"
3032 PRINT "TO THE OUTPUT WHENEVER TH
E PRECEDENCE"
3034 PRINT "OF THE INCOMING OPERATOR
IS LESS THAN"
3036 PRINT "THAT OF THE TOP OF THE ST
ACK."
3038 PRINT
3040 PRINT " USE THE FOLLOWING SPECI
AL CHARACTERS"
3042 PRINT "IN PLACE OF THE LOGICAL O
PERATORS:"
3044 PRINT : TAB 5: PRINT "'AND' - &"
3046 TAB 5: PRINT "'OR' - !"
3048 TAB 5: PRINT "'NOT' - '"
3990 GOSUB WAIT
3999 RETURN
```

Listing 2

```

PROGRAM POLISH;
  USES APPLESTUFF;

CONST
  OUTLINE      =      5;
  HOME         =     12;
  CLREOL       =     29;
  STACKLINE    =      9;
  NESTLINE     =     12;
  NOWPLINE     =     13;
  LASTPLINE    =     14;
  TOKENLINE    =     15;
  TOSLINE      =     16;
  DEBUGLINE    =     22;
  ERRORLINE    =     21;

TYPE
  TOKENVALUE = (NOTOKEN, OPERAND, NOTOP, ANDOP, OROP, LSSOP,
               CTROP, EQLOP, NEGOP, PLUSOP, MINUSOP, MULTOP,
               DIVOP, EXPOP, LPAREN, RPAREN);

  OPERATOR = NOTOP, EXPPOP;
  BYTE     = 0..255;

  STACK = RECORD
    TOS: INTEGER;
    OPS: ARRAY[0..40] OF RECORD
      OPR: OPERATOR;
      PREC: INTEGER;
    END;
  END;

VAR
  TOKEN:      TOKENVALUE;
  EXPRESSION: STRING[40];
  RPN:        STRING[40];
  SCANPTR:    INTEGER;
  NEXTCHAR:   CHAR;
  OPSTACK:    STACK;
  PRECEDENCE: ARRAY[OPERATOR] OF INTEGER;
  OPRCHAR:    ARRAY[OPERATOR] OF CHAR;
  NOWP:       INTEGER;
  LASTP:      INTEGER;
  OI:         INTEGER;
  NEST:       INTEGER;
  DONE:       BOOLEAN;

  PROCEDURE POPSTACK(P: INTEGER); FORWARD;
  PROCEDURE INVERSE;   EXTERNAL;
  PROCEDURE NORMAL;    EXTERNAL;
  PROCEDURE FLASH;     EXTERNAL;

  (*****
  (*   W A I T   *)
  (*****

  PROCEDURE WAIT;
  VAR CH: CHAR;
  BEGIN
    IF KEYPRESS
    THEN
      READ(CH);
    (*ENDIF*)

    REPEAT
      UNTIL KEYPRESS;
    READ(CH);

  END (*WAIT*);

  (*****
  (*   S C R E E N   *)
  (*****

  PROCEDURE SCREEN(CONTROL: BYTE);
  BEGIN
    WRITE(CHR(CONTROL));
  END;

  (*****
  (*   E N T E R   *)
  (*****

  PROCEDURE ENTER(N: STRING);
  BEGIN
    GOTOXY(0, DEBUGLINE);
    WRITE('ENTERING ');
    WRITE(N);
    WAIT;
  END;

```

```

  (*****
  (*   E X I T   *)
  (*****

  PROCEDURE EXIT(N: STRING);
  BEGIN
    GOTOXY(0, DEBUGLINE);
    WRITE('LEAVING ');
    WRITE(N);
    WAIT;
  END;
  (*****
  (*   S T A R L I N E   *)
  (*****

  PROCEDURE STARLINE;
  VAR I: INTEGER;

  BEGIN
    FOR I:=1 TO 40 DO WRITE('*');
    WRITELN;
  END (*STARLINE*);

  (*****
  (*   S H O W N E S T   *)
  (*****

  PROCEDURE SHOWNEST;
  BEGIN
    GOTOXY(25, NESTLINE);
    SCREEN(CLREOL);
    WRITE(NEST);
  END (*SHOWNEST*);

  (*****
  (*   S H O W P R E C   *)
  (*****

  PROCEDURE SHOWPRECEDENCE;
  BEGIN
    GOTOXY(25, NOWPLINE);
    SCREEN(CLREOL);
    WRITE(NOWP);
    GOTOXY(25, LASTPLINE);
    SCREEN(CLREOL);
    WRITE(OPSTACK.OPS[OPSTACK.TOS].PREC);
  END (*SHOWPRECEDENCE*);

  (*****
  (*   P R E C V A L S   *)
  (*****

  PROCEDURE PRECVALS;

  (* INITIALIZE PRECEDENCE ARRAY *)

  BEGIN
    PRECEDENCE[NOTOP] := 1;
    PRECEDENCE[ANDOP] := 2;
    PRECEDENCE[OROP] := 2;
    PRECEDENCE[LSSOP] := 3;
    PRECEDENCE[CTROP] := 3;
    PRECEDENCE[EQLOP] := 3;
    PRECEDENCE[NEGOP] := 3;
    PRECEDENCE[PLUSOP] := 4;
    PRECEDENCE[MINUSOP] := 4;
    PRECEDENCE[MULTOP] := 5;
    PRECEDENCE[DIVOP] := 5;
    PRECEDENCE[EXPOP] := 6;

  END (*PRECVALS*);

  (*****
  (*   O P R V A L S   *)
  (*****

  PROCEDURE OPRVALS;

  (* INITIALIZE STRINGS TO PRINT *)
  (* OPERATORS WITH. *)

  BEGIN
    OPRCHAR[NOTOP] := ' ';
    OPRCHAR[ANDOP] := '&';
    OPRCHAR[OROP] := '!';
    OPRCHAR[LSSOP] := '<';
    OPRCHAR[CTROP] := '>';
    OPRCHAR[EQLOP] := '=';
    OPRCHAR[NEGOP] := '-';
    OPRCHAR[PLUSOP] := '+';
    OPRCHAR[MINUSOP] := '-';

```

(Continued)

```

OPRCHAR[MULTOP] := '*';
OPRCHAR[DIVOP] := '/';
OPRCHAR[EXPOP] := '^';

END (*OPRVALS*);

(*****
(* S H O W T O K E N *)
*****)

PROCEDURE SHOWTOKEN( T: TOKENVALUE);
BEGIN
  GOTOXY(25,TOKENLINE);
  SCREEN(CLREOL);

  CASE T OF

    NOTOKEN: BEGIN END;
    OPERAND: WRITE('OPERAND');
    NOTOP: WRITE('NOTOP');
    ANDOP: WRITE('ANDOP');
    OROP: WRITE('OROP');
    LSSOP: WRITE('LSSOP');
    GTROP: WRITE('GTROP');
    EQLOP: WRITE('EQLOP');
    NEGOP: WRITE('NEGOP');
    PLUSOP: WRITE('PLUSOP');
    MINUSOP: WRITE('MINUSOP');
    MULTOP: WRITE('MULTOP');
    DIVOP: WRITE('DIVOP');
    EXPOP: WRITE('EXPOP');
    RPAREN: WRITE('RPAREN');
    LPAREN: WRITE('LPAREN');

  END;

END (*SHOWTOKEN*);

(*****
(* R P N O U T *)
*****)

PROCEDURE RPNOUT( C: CHAR );
BEGIN
  (* ENTER('RPNOUT'); *)
  GOTOXY(OI,OUTLINE);
  WRITE(C);
  OI := OI + 1;
  (* EXIT('RPNOUT'); *)
END (*RPNOUT*);

(*****
(* I N T R O D U C T I O N *)
*****)

PROCEDURE INTRODUCTION;
BEGIN
  SCREEN(HOME);
  INVERSE;
  WRITELN;
  WRITELN(' DEMONSTRATION OF EXPRESSION PARSING. ');
  NORMAL;
  WRITELN;
  WRITELN(' THIS PROGRAM CONVERTS INFIX NOTATION ');
  WRITELN(' EXPRESSIONS TO REVERSE POLISH NOTATION. ');
  WRITELN(' ALSO KNOWN AS "POSTFIX" NOTATION. ');
  WRITELN;
  WRITELN(' THE INPUT EXPRESSION IS SCANNED FROM ');
  WRITELN(' LEFT TO RIGHT. OPERANDS, IN THIS DEMO ');
  WRITELN(' REPRESENTED BY SINGLE LETTERS OR DIGITS ');
  WRITELN(' ARE OUTPUT WHEN ENCOUNTERED. OPERATORS ');
  WRITELN(' ON THE OTHER HAND ARE STACKED WHEN FIRST ');
  WRITELN(' SCANNED. THE TOP OF THE STACK IS SENT ');
  WRITELN(' TO THE OUTPUT WHENEVER THE PRECEDENCE ');
  WRITELN(' OF THE INCOMING OPERATOR IS LESS THAN ');
  WRITELN(' THAT OF THE TOP OF THE STACK. ');
  WRITELN;
  WRITELN(' USE THE FOLLOWING SPECIAL CHARACTERS ');
  WRITELN(' IN PLACE OF THE LOGICAL OPERATORS. ');
  WRITELN;
  WRITELN(' //AND' - '&');
  WRITELN(' //OR' - '!');
  WRITELN(' //NOT' - '!');
  WAIT;
  SCREEN(HOME);

END (*PROCEDURE INTRODUCTION*);

(*****
(* I N I T I A L I Z E *)
*****)

```

```

PROCEDURE INITIALIZE;
BEGIN
  GOTOXY(0,4);
  STARLINE;
  INVERSE;
  WRITE('OUTPUT');
  NORMAL;
  WRITELN('===>');
  GOTOXY(0,8);
  STARLINE;
  INVERSE;
  WRITE('STACK');
  NORMAL;
  WRITELN('===>');
  GOTOXY(0,NESTLINE);
  INVERSE;

  WRITE('NESTING LEVEL=====');
  SCREEN(CLREOL);
  GOTOXY(0,NOWPLINE);
  WRITE('CURRENT PRECEDENCE===');
  SCREEN(CLREOL);
  GOTOXY(0,LASTPLINE);
  WRITE('LAST PRECEDENCE=====');
  SCREEN(CLREOL);
  GOTOXY(0,TOKENLINE);
  WRITE('TOKEN=====');
  SCREEN(CLREOL);
  GOTOXY(0,TOSLINE);
  WRITE('STACK DEPTH=====');
  SCREEN(CLREOL);
  NORMAL;

END (*PROCEDURE INITIALIZE*);

(*****
(* P R E P R O C E S S *)
*****)

PROCEDURE PREPROCESS;
BEGIN
  NOWP := -1;
  LASTP := -1;
  NEST := 0;
  OPSTACK.TOS := 0; (*TOP OF STACK*)
  OPSTACK.OPSCOPSTACK.TOS.PREC := -1;
  OI := 11; (*OUTPUT INDEX*)
  GOTOXY(OI,OUTLINE);
  SCREEN(CLREOL);
  WRITELN;
  SCREEN(CLREOL);
  SHOWNEST;
  SHOWPRECEDENCE;
END (*PREPROCESS*);

(*****
(* P O S T P R O C E S S *)
*****)

PROCEDURE POSTPROCESS;
BEGIN
  NOWP := -1;
  SHOWPRECEDENCE;
  IF NEST > 0
  THEN
  BEGIN
    GOTOXY(1,ERRORLINE);
    SCREEN(CLREOL);
    FLASH;
    WRITE('TOO FEW RIGHT PARENTHESES');
    NORMAL;
  END;

  IF OPSTACK.TOS > 0
  THEN
  POPSTACK(NOWP);
  (*ENDIF*)

  WAIT;

END (*POSTPROCESS*);

(*****
(* S E T U P *)
*****)

PROCEDURE SETUP;
BEGIN
  PRECVALS;
  OPRVALS;
  INTRODUCTION;
END (*SETUP*);

```

(Continued)

```

(*****
(* S C A N *)
(*****

FUNCTION SCAN : TOKENVALUE;
VAR
RETTOK: TOKENVALUE;
BEGIN
RETTOK := NOTOKEN;
WHILE RETTOK = NOTOKEN DO
BEGIN
NEXTCHAR := EXPRESSION[SCANPTR];
SCANPTR := SCANPTR + 1;

CASE NEXTCHAR OF

'A','B','C','D','E','F','G','H','I','J','K','L','M',
'N','O','P','Q','R','S','T','U','V','W','X','Y','Z',
'0','1','2','3','4','5','6','7','8','9':

RETTOK := OPERAND;

''': RETTOK := NOTOP;
'&': RETTOK := ANDOP;
'!': RETTOK := OROP;
'<': RETTOK := LSSOP;
'>': RETTOK := GTROP;
'=': RETTOK := EQLOP;
'@': RETTOK := NEGOP;
'+': RETTOK := PLUSOP;
'-': RETTOK := MINUSOP;
'*': RETTOK := MULTOP;
'/': RETTOK := DIVOP;
'^': RETTOK := EXPOP;
'(': RETTOK := LPAREN;
')': RETTOK := RPAREN;

END (*CASE*);

IF RETTOK = NOTOKEN
THEN
BEGIN
GOTOXY(0,23);
WRITE('ILLEGAL CHARACTER IN EXPRESSION');
END;

END (*WHILE RETTOK = NOTOKEN*);
SCAN := RETTOK;
SHOWTOKEN(RETTOK);

END (* FUNCTION SCAN *);

(*****
(* P O P S T A C K *)
(*****

PROCEDURE POPSTACK;
VAR
PC: CHAR;
BEGIN

WHILE P < OPSTACK.OPSL[OPSTACK.TOS].PREC DO
BEGIN
PC := OPRCHAR[OPSTACK.OPSL[OPSTACK.TOS].OPR];
RPNOUT(PC);
GOTOXY(9+OPSTACK.TOS,STACKLINE);
WRITE(' ');
OPSTACK.TOS := OPSTACK.TOS - 1;
GOTOXY(25,TOSLINE);
WRITE(OPSTACK.TOS);
END;

END (*POPSTACK*);

(*****
(* P U S H S T A C K *)
(*****

PROCEDURE PUSHSTACK(O: OPERATOR; P: INTEGER);
BEGIN
WITH OPSTACK DO
BEGIN
TOS := TOS + 1;
OPSL[TOS].OPR := O;
OPSL[TOS].PREC := P;
END (*WITH*);
GOTOXY(9+OPSTACK.TOS,STACKLINE);
WRITE(OPRCHAR[O]);
GOTOXY(25,TOSLINE);
WRITE(OPSTACK.TOS);

END (*PUSHSTACK*);

```

```

(*****
(* P A R S E *)
(*****

PROCEDURE PARSE;

BEGIN
SCANPTR := 1;
WHILE SCANPTR <= LENGTH(EXPRESSION) DO
BEGIN

GOTOXY(3+SCANPTR,2);
INVERSE;
WRITE(EXPRESSION[SCANPTR]);
NORMAL;
TOKEN := SCAN;

IF TOKEN = OPERAND
THEN
RPNOUT(NEXTCHAR)
ELSE
IF TOKEN = LPAREN
THEN
BEGIN
NEST := NEST + 1;
GOTOXY(25,NESTLINE);
SCREEN(CLREOL);
WRITE(NEST);
END
ELSE
IF TOKEN = RPAREN
THEN
BEGIN
NEST := NEST - 1;
GOTOXY(25,NESTLINE);
SCREEN(CLREOL);
WRITE(NEST);
END
ELSE
BEGIN

NOWP := NEST*10 + PRECEDENCE[TOKEN];
SHOWPRECEDENCE;
POPSTACK(NOWP);
PUSHSTACK(TOKEN,NOWP);

END (*IF*);
(*ENDIF*)
(*ENDIF*)
WAIT;
GOTOXY(2+SCANPTR,2);
NORMAL;
WRITE(EXPRESSION[SCANPTR-1]);
END (*WHILE*);

END (*PROCEDURE PARSE*);

BEGIN

SETUP;
DONE := FALSE;
REPEAT

INITIALIZE;
GOTOXY(0,1);
INVERSE;
WRITELN('INPUT EXPRESSION TO BE PARSED');
NORMAL;
SCREEN(CLREOL);
WRITE('==>');
READLN(EXPRESSION);

IF LENGTH(EXPRESSION) = 0
THEN
DONE := TRUE;
(*ENDIF*)

PREPROCESS;
PARSE;
POSTPROCESS;

UNTIL DONE;
SCREEN(HOME);

END.

```

A TEAM OF 6809 SUPERSTARS: Smoke Signal's Chieftain™ Computer, and Software by Microware

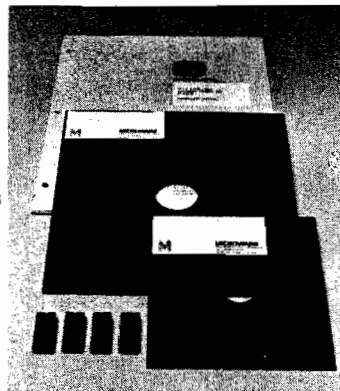
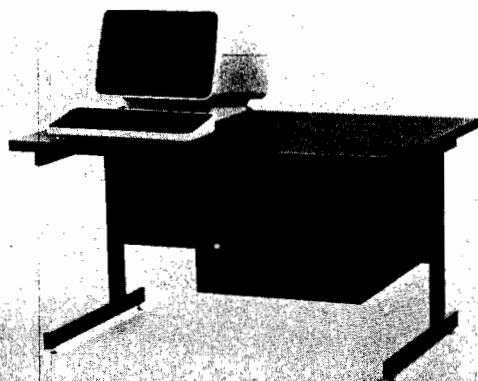

HERE'S THE TOTAL 6809-BASED SYSTEM FOR THOSE WHO DEMAND UNSURPASSED POWER, FLEXIBILITY AND RELIABILITY

After years of worldwide use in diverse and challenging applications, the outstanding performers in 6809 computer operations are SMOKE SIGNAL and MICROWARE. These leading companies are recognized as the undisputed choices **when there is no room for compromises.**

WHY SMOKE SIGNAL AND MICROWARE LEAD THE 6809 FIELD

Smoke Signal began pioneering research and development on 6800/6809-based computer systems back in 1977. Microware worked three years to perfect OS-9 and BASIC09.

Both companies have evolved outstanding 6809-based products from early engineering research, **and both pay almost fanatical attention to detail.** For example . . .

SMOKE SIGNAL'S 6809-based Chieftain™ computer series has **proven** its superiority in hundreds of demanding tasks. From gold-plated connectors to highest-quality materials throughout, each Chieftain™ is built to deliver absolute dependability from day one, and **stay** that way through years of service.

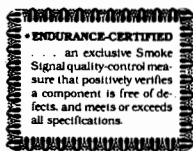

Every Chieftain™ is meticulously **ENDURANCE-CERTIFIED** at 2.2 MHz. That's SMOKE SIGNAL's endorsement of product perfection.

MICROWARE's state-of-the-art OS-9 UNIX*-like operating system and the BASIC09 language have been developed in close coordination with computer manufacturers to maximize optimum system performance. The finest possible support and

*UNIX is a trademark of Bell Telephone Laboratories.

documentation further ensure satisfaction. Microware software performance is best summed up in this remark by a 25-year computer veteran:

"BASIC09 IS THE FINEST HIGH-LEVEL LANGUAGE I'VE EVER SEEN IN THE INDUSTRY!"

Thousands of engineers and programmers use MICROWARE software products as their standard time-saving tool . . . to execute process-control applications . . . and for other vital functions. COBOL and PASCAL are also available under the OS-9 operating system.

HOW THIS REMARKABLE TEAM OF COMPUTER SUPERSTARS CAN SERVE YOU

SMOKE SIGNAL's Chieftain™ computer provides an array of configurations ranging from 5¼-inch drives for single-user applications to multi-user, multi-tasking capabilities. Winchester hard-disk drive systems are also available.

In other words, **breathhtaking power** with as little as 48k memory; Microware's OS-9 Level Two can access up to one full megabyte that your Chieftain™ can address!

One more sampling of the awesome processing potential at your fingertips with the Smoke Signal Chieftain™ computer:

MICROWARE'S Stylograph screen-oriented word processing package instantly makes Chieftain™ an easy-to-use document preparation system with comprehensive editing commands.

THERE'S MUCH, MUCH MORE! Call or write SMOKE SIGNAL for details on Chieftain™ computers and MICROWARE software.

SMOKE SIGNAL Dealer opportunities are still available . . . please request information.

- Send information about Chieftain™ computers and Microware software.
- Provide information about Smoke Signal's Dealer program.

Name _____
 Address _____
 City _____ State _____ Zip _____
 Telephone (_____) _____



**SMOKE SIGNAL
BROADCASTING**



MICROWARE

31336 VIA COLINAS
 WESTLAKE VILLAGE, CA 91362
 TEL (213) 889-9340

MICRO

New Publications

Mike Rowe
New Publications
34 Chelmsford Street
P.O. Box 6502
Chelmsford, MA 01824

General 6809

6809 Assembly Language Programming
by Lance A. Leventhal. OSBORNE/
McGraw-Hill (630 Bancroft Way,
Berkeley, California 94710), 1981, 568
pages, diagrams, charts, listings, 6½ ×
9¼ inches, paperbound.
ISBN: 0-931988-35-7 \$16.99

This is a comprehensive book on 6809 assembly language programming. It is a text both for those who have never before programmed in assembly language and also for experienced programmers, as well as a valuable reference to the 6809 instruction set and programming techniques.

CONTENTS: Section I—Fundamental Concepts: *Introduction Assembly Language Programming*—A Computer Program; High-Level Languages. *Assemblers*—Features of Assemblers; Types of Assemblers; Errors; Loaders. *6809 Machine Structure and Assembly Language*—6809 Registers and Flags; 6809 Addressing Modes; Modes Which Do Not Specify Memory Locations; Memory Addressing Modes; Indexed Memory Addressing Modes; Program Relative Addressing for Branches; 6809 Instruction Set; 6800/6809 Compatibility; 6801/6809 Compatibility; 6502/6809 Compatibility; Motorola 6809 Assembler Conventions. Section II—Introductory Problems: *Beginning Programs*—Program Examples; Problems. *Simple Program Loops*—Program Examples; Problems. *Character-Coded Data*—Handling Data in ASCII; Program Examples; Problems. *Code Conversion*—Program Examples; Problems. *Arithmetic Problems*—Program Examples; Problems. *Tables and Lists*—Program Examples; Problems. Section III—Advanced Topics: *Subroutines*—Program Examples; Position-Independent Code; Nested Subroutines; Problems. *Parameter Passing Techniques*—The PSH and PUL Instructions; General Parameter Passing Techniques; Types of Parameters. *Input/Output Considerations*—I/O Device Categories; Time Intervals; Logical and Physical Devices; Standard Interfaces; 6809 Input/Output Chips. *Using the 6820 Peripheral Interface Adapter (PIA)*—Initializing a PIA; Using the PIA to Transfer

Data; Program Examples; More Complex I/O Devices; Problems. *Using the 6850 Asynchronous Communications Interface Adapter (ACIA)*—Program Examples. *Interrupts*—Characteristics of Interrupt Systems; 6809 Interrupt System; 6820 PIA Interrupts; 6850 ACIA Interrupts; 6809 Polling Interrupt Systems; 6809 Vectored Interrupt Systems; Communications Between Main Program and Service Routines; Enabling and Disabling Interrupts; Changing Values in the Stack; Interrupt Overhead; Program Examples; More General Service Routines; Problems. Section IV—Software Development: *Problem Definition*—Inputs; Outputs; Processing Section; Error Handling; Human Factors/Operator Interaction; Examples; Review. *Program Design*—Basic Principles; Flowcharting; Modular Programming; Structured Programming; Top-Down Design; Designing Data Structures; Review of Problem Definition and Program Design. *Documentation*—Self-Documenting Programs; Comments; Flowcharts as Documentation; Structured Programs as Documentation; Memory Maps; Parameter and Definition Lists; Library Routines; Total Documentation. *Debugging*—Simple Debugging Tools; Advanced Debugging Tools; Debugging With Checklists; Looking for Errors; Examples. *Testing*—Selecting Test Data; Examples; Rules for Testing; Conclusions. *Maintenance and Redesign*—Saving Memory; Saving Execution Time; Major Reorganization. Section V—6809 Instruction Set: *The Instruction Set. Appendices*—A. Summary of the 6809 Instruction Set; B. Summary of 6809 Indexed and Indirect Addressing Modes; C. 6809 Instruction Codes, Memory Requirements, and Execution Times; D. 6809 Instruction Object Codes in Numerical Order; E. 6809 Post Bytes in Numerical Order. *Index*.

Apple

Beneath Apple DOS by Don Worth and Pieter Lechner. Quality Software (6660 Reseda Blvd., Suite 105, Reseda, California 91335), 1981, 174 pages, diagrams, charts, drawings, 5 3/8 × 8 3/8 inches, plastic comb binding with cardstock cover. \$19.95

This book is intended to serve as a companion to Apple's DOS Manual, providing additional information for the advanced programmer or the novice Apple user who wants to know more about the structure of diskettes.

CONTENTS: *Introduction; The Evolution of DOS*—DOS 3; DOS 3.1; DOS 3.2; DOS 3.2.1; DOS 3.3. *Diskette Formatting*—Tracks and Sectors; Track Formatting; Data Field Encoding; Sector Interleaving. *Diskette Organization*—Diskette Space Allocation; The VTOC; The Catalog; The Track/Sector List; Text Files; Binary Files; Applesoft and Integer Files; Other File

Types; Emergency Repairs. *The Structure of DOS*—Dos Memory Use; The DOS Vectors in Page 3; What Happens During Booting. *Using DOS from Assembly Language*—Direct Use of the Disk Drive; Calling READ/WRITE Track/Sector (RWTS); RWTS IOB by Call Type; Calling the DOS File Manager; File Manager Parameter List by Call Type; The File Manager Work Area; Common Algorithms. *Customizing DOS*—Slave vs. Master Patching; Avoiding Reload of Language Card; Inserting a Program Between DOS and Its Buffers; BRUN or EXEC a HELLO File; Removing the Pause During a Long Catalog. *DOS Program Logic*—Controller Card ROM — Boot 0; First RAM Bootstrap Loader — Boot 1; DOS 3.3 Main Routines; DOS File Manager; READ/WRITE Track/Sector; DOS Zero Page Use. *Appendix A. Example Programs*—Track Dump Program; Disk Update Program; Reformat a Single Track Program; Find Track/Sector Lists Program; Binary to Text File Convert Program. *Appendix B. Disk Protection Schemes. Appendix C. Glossary. Index*.

Apple II User's Guide by Lon Poole, with Martin McNiff and Steven Cook. OSBORNE/McGraw-Hill (630 Bancroft Way, Berkeley, California 94710), 1981, xii, 386 pages, photos, diagrams, tables, listings, 6 × 9¼ inches, paperbound. ISBN: 0-931988-46-2 \$15.00

This guide to the Apple II computer describes both the Apple II and the common peripheral devices including disk drives and printers. It assumes access to an Apple II system already hooked up.

CONTENTS: *Introduction. Presenting the Apple II*—(Keyboard and TV, Inside the Apple II, Memory, Cassette Recorder, Disk Drive, Programs, External Device Controllers, Game Controls, Printer, Graphics Tablet). *How to Operate the Apple II*—Turning the Power On (What You See on the TV, The Prompt Character); The Keyboard, The Cassette Recorder; Using the Disk II (The Disk Operating System, Preparing Blank Diskettes); Loading and Running a Program (Use the Right Version of BASIC, Loading a Program from Cassette, Loading a Program from Disk, Starting a Program Running, Setting TV Color); Miscellaneous Components; Coping with Errors (Error Messages, Correcting Typing Mistakes, Accidental Reset). *Programming in BASIC*—(Starting Up BASIC); Immediate and Programmed Modes (Printing Characters, Printing Calculations, Error Messages, Extra Blank Statements, Statements, Lines and Programs, Programmed Mode, Saving Programs on Cassette); Switching BASICs; Advanced Editing Techniques (Deleting Program Lines, Adding Program Lines, Changing Program Lines, Reexecuting in Immediate Mode);

(Continued on page 91)

MICRO

Classified

SYM-1 Expansions

Bare W7AAY 4K RAM board - \$8.00 plus SASE. Assembled W7AAY ROM board - \$16.00. RAE symbolic disassembler source on cassette - \$15.00. Instruction packet to add floppy disks to SYM - \$15.00. RAE/KMMM software interface on 5¼" diskette - \$15.00. SASE for more information.

John M. Blalock
Blalock & Associates
P.O. Box 39356
Phoenix, AZ 85069

OSI Superboard — Cabinet and Accessories

Pre-cut kit with hardware to build a handsome pine cabinet to house your superboard. Room inside for the power supply and all your extras, \$20. RS-232 interface kit, \$10. Send for our catalog of software, hardware, kits and accessories.

Dee Products
150 Birchwood Road
Carpentersville, IL 60110

Space Invaders for OSI

Bug free, smooth action, addictive, entirely in machine language. Requires only 2K and loads in 1½ minutes. Includes color, sound, 10 skill levels, and optional joystick control. Difficulty increases as game progresses. For C2-4P, C4P tape systems. \$12.00.

Mike Kincaid
6653 Lunde Rd.
Everson, WA 98247

Used Micro Listing Service

Save time, money, mistakes, frustration. List as Buyer/Seller — Apple, PET, OSI, CP/M systems, floppies, printers — all equipment \$300 and up. Pay only for results. Get thorough advice and listings over the phone. Call now: 800-327-9191 x 61 or 703-471-0044.

Used Computer Exchange
2329 Hunters Woods Plaza
Reston, VA 22091

New General Ledger by SBCS

This system for the Apple II is based on our standard G/L and is even more flexible and efficient. It includes increased error checking and user prompting. Reports are more detailed and include budgeting. Documentation is rewritten to provide more detail and clarity.

Small Business Computer Systems
4140 Greenwood
Lincoln, NE 68504
402/467-1878

Apple Undeleter

Apple Undeleter restores deleted, unrewritten files of all types. Written in heavily commented Applesoft for easy understanding, copying and modification, Undeleter works with any memory size Apple and is available for DOS 3.2 and 3.3. Price is \$12.00 ppd.

D. Cox
787 Gantry Way
Mountain View, CA 94040

Timestack — A Programmable Controller

Expand your KIM-1 into a general-purpose machine. 80-page manual documents Clock/Port/RAM/PROM Expansion Board and controller software. Subroutine library includes user interaction routines, I/O, and clock controls. Complete manual — \$15.00. SASE for more information and newsletter.

Hunter Services
P.O. Box 359
Elm Grove, WI 53122

Accounts Receivable by SBCS

This conversion of Osborne's Accounts Receivable software for the Apple II contains the same capabilities, plus many enhancements that increase your Apple's flexibility, speed, and performance. Use alone or integrate with General Ledger. Retail price \$249.

Small Business Computer Systems
4140 Greenwood
Lincoln, NE 68504
402/467-1878

AIM 65 Utilities

Improve productivity with quality AIM software. UTIL1 package adds 18 commands to the AIM monitor. Copy and move capability for the editor, memory search and move, virtual I/O and much more. Manual \$5 or send SASE for information on this and other software.

Nehalem Bay Software
25730 Beach Dr.
Rockaway, OR 97136

AIM-65 Newsletter * * Target

Target provides hardware and software information useful for AIM-65 and 6502 users. The 1979 and 1980 back issues are available for \$12.00 while a continuing subscription costs \$6.00. Just write to:

Target
Donald Clem
Route 2
Spenserville, OH 45887

PET/CBM Owners

Real world software at low cost. 2114 RAM adapter and 4K Memory Expansion for "old" 8K PETs. Write for free catalog!

Optimized Data Systems
Dept. M, Box 595
Placencia, CA 92670

C1P Extended Monitor

2K EPROM has 14 cursor control/editing functions, improved keyboard decoding. Machine language save, load, display, modify, move, breakpoint processing and much more. For 24, 32, 64 char/line. \$39.95 plus \$1.00 shipping. \$1.00 for complete information.

Bustek
P.O. Box A
St. Charles, MO 63301

Spanish Hangman

2,000 SPANISH words and sentences taught in a fun way on the Apple. Send for your school's free 30-day evaluation diskette, from:

George Earl
1302 South General McMullen
San Antonio, TX 78237

Business Software by ADS

For the Apple II and Atari/800. Why pay more for a bunch of unrelated programs? Business Plus will handle invoices, statements, credit memos and more, much more! Just \$299 complete or \$25 for demo disk (credited towards purchase). VISA, Mastercharge accepted.

Advanced Data Systems
7468 Maple Avenue
St. Louis, MO 63143
314/781-9388

Each classified ad costs only \$10.00 per insertion, pre-paid with typewritten copy. Please limit these entries to less than 40 words. (Oversized ads will be rejected and returned.) Title line, name and address are not considered in count. Ads received before the 20th of the second month preceding the month of publication will be published in next issue, i.e. May 20th for the July issue. For further information, call (617) 256-5515.

WHAT'S NEW?

Consumer Computers announces it's lowest prices ever.

Apple Add-Ons

Language System w/Pascal	379
Hayes Micromodem II	299
Novation Apple-Cat II	339
Videx Videoterm 80 w/graphics	269
2-80 Microsoft Card	269
16K Ram Card Microsoft	159
ABT Numeric Keypad (old or new hybrid)	110
ALF 3 Voice Music Card	239
Heuristics Speechlink 2000	249
Alpha Syntauri Keyboard System	1399
Convus 10 MB Hard Disk	CALL
Lazer Lower Case Plus	50
Micro-Sci Disk Drives (A40 & A70)	CALL
55M AIO Serial/Parallel Card A&T	189
ThunderClock Plus	CALL
Integer or Applesoft II Firmware Card	145
Graphics Tablet	619
Parallel Printer Interface Card	135
Hi-Speed Serial Interface Card	135
Smarterm 80 Column Video Card	299
MusicSystem (16 voices)	479
A/D + D/A interface	289
Clock/Calendar Card	225
Supertalker 5D-200	239
Romplus + Card	135
Clock/Calendar Module (CCS)	99
Asynchronous Serial Interface Card (CCS)	129
We carry all CCS hardware	Please Call

Apple II Plus Computer

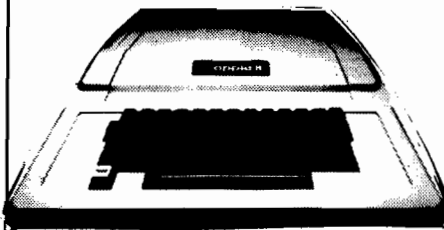

16K 48K
\$1025 \$1129

Disk II Drive
w/controller **\$519**

Disk drive w/out controller 439

We carry the Apple III

Printers, Etc.

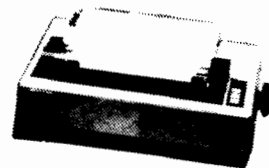

Epson MX-80
\$499

Silentype w/Apple Interface	349
Epson MX-80 F/T	649
Epson MX-100	829
Epson MX-70	339
Paper Tiger ID5-445	729
Paper Tiger ID5-460	1099
Paper Tiger ID5-560	1450
Qume Sprint 5/45	2495
Anadex DP-9500/ w/2K Buffer	1349
C. Itoh Starwriter 25 CPS	1649
C. Itoh Starwriter 45 CPS	2249
Centronics 737	699
Watahabe DigiPlot	1149

FREE CATALOG!

Please mail us your name and address.

Solution Software for the Apple II.

Visicalc 3.3	169
CCA Data Management	85
DB Master	169
WordStar (Apple 80 col. ver.)	299
Desktop Plan II	169
Applewriter	65
Easywriter	225
Appleplot	60
Peachtree Business	1200
VisiTerm	129
VisiTrend/VisiPlot	219
DOS Toolkit	65
Dow Jones Portfolio Evaluator	45
Dow Jones News & Quotes Reporter	85
Apple Fortran	165

CALL FREE!

800-854-6654

In California and outside continental U.S.

(714) 698-8088

Warehouse (714) 698-0260

Service (714) 460-6502

TELEX 695000 BETA CCMO

AVAILABLE NOW . . .



The NEC Microcomputer

Please call for more details.

Exidy Sorcerer II

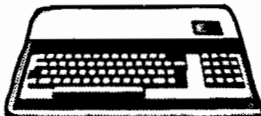

Please call
for
our price.

S-100 Unit	449
Word Processing Pac	179
Development Pac	89

Atari Personal Computer

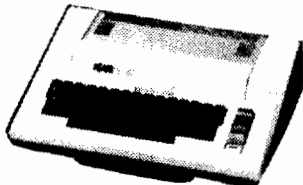

ATARI 800 16K \$749

Atari Accessories

410 Program Recorder	59
810 Disk Drive	449
850 Interface Module	159
16K Ram Memory Module	89

Please call us for an Atan Software List.

S-100 Cards

SSM	MR	Assm & Tested
2-80 CPU CS-2	219	279
04 2 P + 25 I/O	189	249
VB-3 80 x 24 VIDEO	329	379
VB-3 80 x 48 VIDEO	369	429
BV-2 VIDEO	159	219
PB1 PROM PROGRAMMER & EPROM BOARD	139	199

CCS

280 CPU 2810	n/a	229
64K Dynamic RAM card	n/a	499
16K Static RAM 2 Mhz	n/a	249
16K Static RAM 4 Mhz	n/a	269
Dbl. Density Floppy Disc Controller	n/a	299
12 Slot S-100 Mainframe	n/a	349

PMC-80 Micro Computer

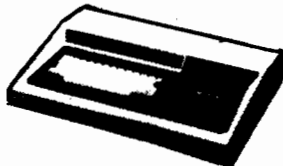

\$599

Ohio Scientific Challenger Computer.



4P \$549

1P MOD II 399

Save on Video displays.

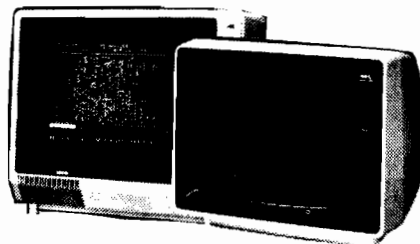

Amdek/Leedex Video 100 12" B&W	139
Amdek (Hi-tachi) 13" Color	359
NEC 12" P31 Green Phosphor	CALL
NEC 12" RGB Hi-Res Color	CALL
Panasonic 13" Color	449
Sanyo 9" B&W	159
Sanyo 12" B&W	239
Sanyo 12" P31 Green Phosphor	279
Sanyo 13" Color	419

We carry much more than listed. Please call our toll free order line to request our complete price list.

How to Order

Ordering information: Phone orders using VISA, MASTER-CARD, AMERICAN EXPRESS, DINER'S CLUB, CARTE BLANCHE, bank wire transfer, cashiers or certified check, money order, or personal check (allow ten days to clear.) Unless prepaid with cash, please add 5% for shipping, handling and insurance. (minimum \$5.00). California residents add 6% sales tax. We accept CODs, OEM's, Institutions and corporations please send for a written quotation. All equipment is subject to price change and availability without notice. All equipment is new and complete with manufacturer's warranty (usually 90 days). Showroom prices may differ from mail order prices.

Send orders to:

**consumer
computers**

Mail Order

**8314 Parkway Drive
La Mesa, California 92041**

Common Array Names in Applesoft II

Here is a new command for Applesoft II. Its function is to change the names of floating point and integer arrays during program execution.

Steve Cochard
P.O. Box 236
Boyertown, Pennsylvania 19512

One aspect of the BASIC language which differs from other high-level languages, such as FORTRAN, is its lack of ability to handle subroutine calls with parameter lists. This feature of FORTRAN allows the programmer to specify what variables are to be passed to a subroutine. The FORTRAN subroutine name and subroutine call contain lists of the variable names to be used in the subroutine. What this does is to allow the programmer to call standard or "canned" subroutines from the main program without rewriting the subroutine to incorporate the variable names used in the main or calling program.

Any Apple disk user who keeps a subroutine library on disk must have come across this problem with Applesoft. The current solution is to either rewrite the subroutine to incorporate the variable names as used in the main program, or tailor the main program to conform with the standards established by the subroutines in use.

Another, somewhat smaller problem, is interchanging the elements of one array with those of another. This is found in game-type applications frequently. The current solution is to write a FOR-NEXT loop of sufficient depth, to swap each element. Needless to say, as the size or number of dimensions increases, so too does the execution time.

Listing 1: Trivial program to show name changing and speed of an & command relative to BASIC. Note that the machine language program must be loaded at \$300 for proper operation of program listings 1 and 2.

```
1 POKE 1013,76:POKE 1014,0: POKE 1015,3
10 DIM A(15),B(15),C(1000),D(15),E(1000)
20 FOR I= 1 TO 1000
30 C(I)=INT(RND(1)*500)
40 NEXT
50 HOME: PRINT "INITIALIZED, HIT ANY KEY TO TRANSFER
ELEMENTS OF ARRAY C TO ARRAY E";:GET AS
100 FOR I= 1 TO 1000
110 TEMP= C(I)
120 C(I)= E(I)
130 E(I)= TEMP
140 NEXT
150 PRINT "ELEMENTS 500 TO 510 OF ARRAY 'E'"
160 FOR I= 500 TO 510
170 PRINT E(I),: NEXT
180 PRINT "TRANSFER COMPLETE. HIT ANY KEY TO TRANSFER
BACK USING COMMON ARRAY NAME COMMAND";:GET AS
200 &(C,T) :REM CHANGE 'C' TO 'T'
210 &(E,C) :REM ARRAY 'E' NOW HAS THE NAME 'C'
220 &(T,E) :REM ARRAY 'C' HAS THE NAME OF 'E'
230 PRINT "TRANSFER COMPLETE. ELEMENTS RESTORED IN ARRAY
'C'"
240 FOR I= 500 TO 510
250 PRINT C(I),:NEXT
260 PRINT "DONE"
```

Listing 2: Another trivial program to show the use of the name change feature in use with subroutines.

```
1 POKE 1013,76:POKE 1014,0:POKE 1015,3
10 DIM A(15),B(15,15),C(10),D(25)
15 PRINT "THE ARRAY 'C'"
20 FOR I= 1 TO 10
30 C(I)= INT(RND(1)*100)
40 PRINT C(I),
50 NEXT
60 &(C,J)
70 GOSUB 200
80 &(J,C)
90 PRINT "THE ARRAY 'C' IS RESTORED"
100 FOR I= 1 TO 10: PRINT C(I),: NEXT: END
200 PRINT "THE ARRAY 'J'"
210 FOR I= 1 TO 10
220 PRINT J(I),:NEXT: RETURN
```

What do these two, seemingly unrelated, problems have in common? Each has the identical, simple solution: change the names of the arrays during program execution.

With the first problem, the solution is to simply change the names of the arrays stored in memory to those used in the subroutine before calling the subroutine. After subroutine execution, the names are changed again to the original. The second problem is solved not by interchanging array elements, but simply by interchanging array names.

The assembly language program presented here solves these problems by changing the names of integer or floating point arrays as stored in the Apple during program execution. The program uses the ampersand (&) as the interface between BASIC and itself. This feature of Applesoft greatly simplifies using utilities such as this. A very brief explanation of the & command may be found in the Applesoft II manual, and is included here for the sake of continuity.

This symbol, when executed as an instruction, causes an unconditional jump to location \$3F5.

Since this is the case, all that needs to be done is to place a JMP instruction in this location to the start of the machine language routine to be used. For this utility, which is assembled at location \$300, the user would, from the monitor, enter the following to set the & "hook":

```
*3F5:4C 00 03
```

This, of course, may also be done from the BASIC program by the appropriate use of POKES. In this example the following program line would need to be executed prior to utilizing the & command:

```
100 POKE 1013,76: POKE 1014,0
: POKE 1015,3
```

Or in general form:

```
LINE# POKE 1013,76;POKE 1014,
(ADDRESS MOD 256): POKE
1015, (ADDRESS/256): REM
ALL NUMBERS = INTEGERS
```

Once this is done the hook remains set until changed by either the program or user, or the computer is powered down.

Listing 3

```

1000 *-----
1010 *
1020 *      COMMON ARRAY      *
1030 *      NAMES IN        *
1040 *      APPLESOFT II     *
1050 *      BY               *
1060 *      S. COCHARD       *
1070 *      (C) 1980        *
1080 *
1090 * (S-C ASSMB II <4.0> FORMAT) *
1100 *
1110 *-----
1120 *
1130 * NOTE: ONLY GLOBAL LABELS HAVE BEEN USED
1140 *      FOR COMPATABILITY WITH OTHER ASSEMBLERS
1150 *
1160 *
1170 *      .OR $300
006B- 1180 PTR1 .EQ $6B      START OF ARRAY SPACE
006D- 1190 PTR2 .EQ $6D      END OF ARRAY STORAGE
0071- 1200 TEMP .EQ $71      TEMP STORAGE
0073- 1210 MASK .EQ $73
00B1- 1220 CHRGT .EQ $B1     APPLESOFT CHRGET ROUTINE
0210- 1230 NAME .EQ $210     TEMP STORAGE
0216- 1240 NAM2 .EQ $216     TEMP STORAGE
0220- 1250 ZPSV .EQ $220     TEMP STORAGE
DEC9- 1260 SNTX .EQ $DEC9     SYNTAX ERROR
1270 *
1280 * START OF PROGRAM
0300- 4B 1290 START PHA      SAVE FIRST CHARACTER
0301- A2 0A 1300 LDX #10     SAVE SOME ZERO PAGE
0303- B5 6B 1310 STA1 LDA PTR1,X
0305- 9D 20 02 1320 STA ZPSV,X
0308- CA 1330 DEX
0309- 10 F8 1340 BPL STA1
030B- A9 00 1350 LDA #00     CLEAR MASK
030D- 85 73 1360 STA MASK
030F- A2 0C 1370 LDX #0C
0311- 9D 10 02 1380 LOOP STA NAME,X  CLEAR NAME
0314- CA 1390 DEX
0315- 10 FA 1400 BPL LOOP
0317- 68 1410 PLA
0318- C9 28 1420 CMP #'(  GET FIRST CHAR BACK
031A- F0 02 1430 BEQ CON7  SEE IF IT'S A '(
                                YES! CONTINUE

031C- D0 1A 1440 BNE SYER  NO! SYNTAX ERROR
031E- 20 B1 00 1450 CON7 JSR CHRGT  CONTINUE WITH CHAR'S
0321- 8D 10 02 1460 STA NAME  AND SAVE IT.
0324- E8 1470 INX
0325- E8 1480 L001 INX      GET SOME MORE TEXT
0326- E0 06 1490 CPX #06  LEN OF NAME GREATER
0328- D0 02 1500 BNE CON3  THAN 6 CHARACTERS?
032A- F0 0C 1510 BEQ SYER  YES! THEN ERROR!
032C- 20 B1 00 1520 CON3 JSR CHRGT  CONTUNUE WITH CHAR'S
032F- C9 2C 1530 CMP #' ,  END OF ARRAY NAME?
0331- F0 08 1540 BEQ CON1  YES! NEXT NAME
0333- 9D 10 02 1550 STA NAME,X  NO! STORE IT.
0336- D0 ED 1560 BNE L001  JUMP BACK FOR MORE.
0338- AC C9 DE 1570 SYER JMR SNTX  JUMP TO APPLESOFT SYNTAX ERR
033B- CA 1580 CON1 DEX      IS ARRAY AN INT ARRAY?
033C- BD 10 02 1590 LDA NAME,X
033F- C9 25 1600 CMP #'Z
0341- D0 09 1610 BNE CON1  NO, A FP ARRAY
0343- A9 80 1620 LDA #$80  YES, SET MASK FOR NEG
0345- 85 73 1630 STA MASK  ASCII.
0347- A9 00 1640 LDA #00  NEXT, CLEAR X CHAR IN NAME
0349- 9D 10 02 1650 STA NAME,X
034C- A2 00 1660 CON1 LDX #00  GET SECOND NAME.

```

Listing 3 (Continued)

```

034E- 20 B1 00 1670 L002 JSR CHRGT
0351- C9 25 1680 CMP #X IS IT AN INT.ARRAY?
0353- D0 02 1690 BNE CON8 NO, A FP ARRAY
0355- A9 00 1700 LDA #00 YES, SET CHAR=0
0357- C9 29 1710 CON8 CMP #' ) END OF NAME?
0359- F0 0A 1720 BEQ CON2 YES! CONTINUE
035B- 9D 16 02 1730 STA NAM2,X NO! STORE NAME # 2
035E- EB 1740 INX
035F- E0 06 1750 CPX #06 LEN GREATER THAN 6?
0361- D0 EB 1760 BNE L002 NO, CONTINUE!
0363- F0 D3 1770 BEQ SYER YES! ERROR!
0365- A2 0C 1780 CON2 LDX #00C MASK NAMES.
0367- A5 73 1790 CON4 LDA MASK
0369- 5D 10 02 1800 EOR NAME,X
036C- 9D 10 02 1810 STA NAME,X
036F- CA 1820 DEX
0370- 10 F5 1830 BPL CON4
1840 *
1850 * LDCATE WHERE ARRAY IS STORED
1860 *
0372- A0 00 1870 L003 LDY #00 LOOK AT FIRST NAME IN MEM.
0374- B1 6B 1880 LDA (PTR1),Y
0376- CD 10 02 1890 CMP NAME IS IT = TO NAME
0379- D0 0A 1900 BNE CON5 NO, LOOK SOME MORE
037B- CB 1910 INY NEXT CHAR IN NAME.
037C- B1 6B 1920 LDA (PTR1),Y
037E- CD 11 02 1930 CMP NAME+1 IS IT = NAME+
1940
1950
0381- D0 02 1960 BNE CON5 NO, LOOK SOME MORE.
0383- F0 2A 1970 BEQ FIND FOUND ARRAY! NOW CHANGE IT
0385- A0 02 1980 CON5 LDY #02 GET OFFSET TO NEXT ARRAY.
0387- B1 6B 1990 LDA (PTR1),Y
0389- 85 71 2000 STA TEMP SAVE HI BYTE.
038B- CB 2010 INY
038C- B1 6B 2020 LDA (PTR1),Y
038E- 85 72 2030 STA TEMP+1 SAVE LO BYTE
0390- 18 2040 CLC SET UP TO ADD
0391- A5 6B 2050 LDA PTR1
0393- 65 71 2060 ADC TEMP
0395- 85 6B 2070 STA PTR1
0397- A5 6C 2080 LDA PTR1+1
0399- 65 72 2090 ADC TEMP+1
039B- 85 6C 2100 STA PTR1+1
039D- A5 6E 2110 LDA PTR2+1 WAS THAT THE LAST ARRAY
039F- C5 6C 2120 CMP PTR1+1 IN MEMORY?
03A1- F0 04 2130 BEQ CON6 MAYBE!
03A3- 10 CD 2140 BPL L003 NO! NOT THIS TIME!
03A5- 30 13 2150 BMI RTRN WAY PAST IT. TIME TO END!
03A7- A5 6D 2160 CON6 LDA PTR2 HOW 'BOUT LO BYTE
03A9- C5 6B 2170 CMP PTR1
03AB- F0 0D 2180 BEQ RTRN YES, THIS IS THE END
03AD- D0 C3 2190 BNE L003 NOPE, CONTINUE.
2200 * SWITCH NAMES IN MEMORY
2210 *
03AF- AD 17 02 2220 FIND LDA NAM2+1 FOUND IT. NOW
03B2- 91 6B 2230 STA (PTR1),Y SWITCH NAMES.
03B4- 8B 2240 DEY
03B5- AD 16 02 2250 LDA NAM2
03B8- 91 6B 2260 STA (PTR1),Y
03BA- A2 0A 2270 RTRN LDX #10 RESTORE ZERO PAGE
03BC- BD 20 02 2280 RTR1 LDA ZPSV,X
03BF- 95 6B 2290 STA PTR1,X
03C1- CA 2300 DEX
03C2- 10 F8 2310 BPL RTR1
03C4- 20 B1 00 2320 JSR CHRGT GET LAST CHARACTER
03C7- 60 2330 RTS AND RETURN TO BASIC

```

To use the COMMON ARRAY NAME program the program must first be loaded into memory. Since the program is relocatable, it will operate correctly without changes when residing anywhere in memory. A convenient place is starting at hex \$300 (768 decimal). Next set the & hooks to the starting address of the program and it is ready to run.

The command to change an array name is of the following form:

```

&[AA,BB]
&[CAT%,DOG%]

```

or in general form:

```

&[name1(%),name2(%)]

```

The % is optional and depends on the array type (int/fp). The command may be used in immediate execution mode or deferred execution mode (within a program). Program listing 1 and listing 2 show examples of the command in use.

Certain limitations are imposed when using this program. Floating point array names are restricted to a maximum of five characters, integer arrays have a maximum of four. This does not limit the versatility of the program, however, since only the first two characters of any variable name are significant in Applesoft. If a longer array name is in use, just shorten it to four or five characters for use in the & command. Everything will work out OK.

Array types may not be intermixed. That is, a floating point array will not be changed to integer and vice-versa.

Two array names must be present in the & command. If not, the program will assume that the first character after the comma is the second name. If used in this way, it is possible to have an array internally renamed to ") ".

If the first (old) array name in the command does not exist in the variable table, no changes will take place. This condition is not signaled to the user. Therefore, care should be taken to have the array DIMensioned prior to using the name change feature.

The Program

The program, quite simple in operation, consists of three parts. The first section reads the old and new array names from the Applesoft & statement. It then stores these names and checks for the array type, either integer or FP.

The two are differentiated, of course, by the presence or absence of the % sign in the array name. Applesoft, however, knows nothing of % signs. It differentiates the two by how the name is stored in memory. Floating point array names are stored as positive ASCII, integers as negative ASCII. In other words, the high order bit is clear or set, respectively. This is dealt with in the program by examining the last character in the first array's name. If it is a %, then a mask is set equal to \$80, which in binary is a one followed by seven zeros. If the array is a floating point, then the mask is set equal to zero. With this done, all that is necessary is to "exclusive or" the names with the mask. This will set or clear the high order bit as required.

The second section of the program locates the array in memory. It first picks up the pointer to the start of array storage from locations \$6B and \$6C. Then the locations pointed to are examined and compared to the first name in the BASIC statement. If there is a match (if the array has been found), the program branches to the third section. If it is not a match, the offset to the next array is picked up from the variable table and added to the pointer. Now the pointer points to the name of the next array in memory. This process is repeated until either a match is found or the limit of array storage is reached. In this case, the program returns to BASIC but does not signal the user that a change has not taken place. Since this is so, the user should be sure the "old" array has been previously DIM'd in the BASIC program before attempting to change its name.

The third section does the actual work of changing the array name. All that is done, is that the "new" name is stored in place of the "old" one in the variable table.

The program has been designed to be completely portable, in that it will execute anywhere in memory. This has been accomplished by utilizing no absolute JMPs within the program by using forced branches. This results in a program with only relative branches (which are location-independent), and a program which may be loaded anywhere that free memory exists in the Apple.

The first two sections of this program are of great versatility, as the reader may have observed by this point. These routines may be incorporated in many other array-handling utilities to form the basis for programs to do such things as clear an array, equate two arrays, delete an array, etc.

MICRO

Mike Rowe
34 Chelmsford Street
P.O. Box 6502
Chelmsford, MA 01824

Hardware Catalog

Name: **Pre-cut Cabinet Kit**
System: Ohio Scientific
Superboard II

Description: This cabinet, manufactured by DEE Products, comes as a pre-cut kit built large enough to house the Superboard along with the 610 memory expansion board. The cabinet also has room for cooling fan, power supply and, (mounted on the rear panel) switches, connectors, and jacks. Built of pine, this handsome cabinet resembles the C1P cabinet and also incorporates a 10 degree tilt to the keyboard, easing use. When finished, this kit makes a quality protective home for your Superboard. Gluing and finishing required.

Price: \$20.00 ppd.
Available: DEE Products
150 Birchwood
Lake Marion, IL 60110

Name: **Co-Ax Switching Matrices**

Description: Family of co-ax switching matrices with high speed, long life, high isolation. Cover DC to 1.26 Hz range, insertion losses as low as 0.2 db, available up to 10 x 10 in a single housing, bidirectional. Available with IEEE-488, RS-232C bus or telephone or remove manual interfaces. For switching video, data, RF.

Price: \$2400 for typical 5 x 8 matrix
Available: Mar Lee Switch Co.
9330 N. Central Ave.
Upland, CA 91786

Name: **Bytewriter-1**
Memory: One line buffer capacity
Language: BASIC
Description: 7 x 7 dot matrix printer, friction feed, 80 c.p.s., 60 l.p.m., interfaces Apple, Atari and TRS-80, 80-columns per line and double-wide character set.

Price: \$299.00
Available: Microtek, Inc.
9514 Chesapeake Dr.
San Diego, CA 92123

Name: **Model Q3 Printer Mechanism**

Memory: 45-Character Buffer
Description: The Model Q3 Printer is an exceptionally rugged, non-impact, thermal printer which is designed to provide the optimum in quiet operation. The Q3 features high resolution

plotting capabilities (dot resolution of 0.17) giving the user flexibility to quickly present meaningful statistic graphs. The standard 80/132 selectability ensures users will have neatly formatted reports. Only 4½ pounds, the Q3 prints a full USASCII 5 x 7 dot matrix 96-character set.

Price: \$825.00
Available: Computer Devices, Inc.
25 North Avenue
Burlington, MA 01803

Name: **Kleen-Line Isolator**
System: Model ISO-3
Hardware: Stand-alone A.C. power conditioning

Description: Eliminates interaction between processor, printer and peripherals. Also isolates equipment from power line noise and hash as well as high-voltage spikes and transients.

Price: \$94.95
Available: Electronic Specialists
171 South Main St.
Natick, MA 01760

Name: **Pro-Paddle**
System: Apple II

Description: Pro-Paddle is the only heavy-duty paddle available for the Apple II. It features compact sturdy metal construction, long-life switches with large buttons and tactile feedback, high accuracy paddle movement, shielded coaxial cables, and a molded plug. They are constructed of the highest quality materials and workmanship available.

Price: \$39.95 includes paddles and I/O cable

Author: Computerworks
Available: Rainbow Computing,
Mail Order Dept.
19517 Business Center
Drive
Northridge, CA 91324

Name: **Micromodem 100**
System: S-100 Bus Computers
Hardware: Low Speed Modem
Description: Direct connect data communications system for S-100 bus computers. Features 110 and 300 baud, full or half duplex and programmable auto dial and auto answer capabilities.

Price: \$379.00 (suggested retail)
Available: Hayes Microcomputer Products, Inc.
5835A Peachtree Corners
East
Norcross, GA 30092

MICRO

The Extended Parser for the Apple II

This extended parser for the Apple II or Apple II Plus allows easy control of functions such as clear screen, delete to end of line, flash, and inverse.

Paul R. Wilson
19 Sunset Place
Bergenfield, New Jersey 07621

Back in the June 1980 MICRO (25:15), Edward H. Carlson wrote a sample extension for the parser of the Ohio Scientific computers. He stated that all Microsoft BASIC languages use this parser. I have checked both the Apple's and PET's and they jive with the parser of the Ohio Scientific, save in minor points.

The following is an excellent parser for the Apple II or Apple II Plus as it contains seven useful functions.

Table 1

BASIC	PARSER
CALL -936 (or HOME)	#S clears entire screen
CALL -958	#E clears screen from cursor to end
CALL -868	#L clears from cursor to end of line
POKE 50,127 (or FLASH)	#F puts output into flash mode
POKE 50,63 (or INVERSE)	#I puts output into inverse mode
POKE 50,255 (or NORMAL)	#N restores output to normal mode
TEXT	#T restores screen to text mode

Text in table 1 does not do a complete job. After use of Hi-Res, a later GR will not function properly. The Hi-Res screen will appear instead of Lo-Res. The T-command performs a C056 or

POKE -16298,0 to restore GR's proper function, after the C051 or POKE -16303,0. It resets the scrolling screen to full size, but does not send the cursor to the bottom of the screen like TEXT. I only discovered this after I acquired my Disk Drive, which encourages quick succession of programs in one sitting. In many of them, I inserted POKE -16298,0 to guarantee that a use of Hi-Res in some previous program will not interfere with Lo-Res in the new one.

Although Mr. Carlson stated the syntax requirements of the parser in his June, 1980 article, some of you may not have read that, so I will repeat such. A "%" or "#" must precede the special one-keystroke commands. In immediate mode, they will be executed before

the BASIC interpreter knows that they were even there. In deferred mode, the parser will not accept X #EXPR, but will execute it at once. You must enter it as X %EXPR. The parser will change % to # in sending the input line to memory.

Not only do these routines save typing, but they do not have to be interpreted. The BASIC interpreter takes time in finding and calling up the proper routines. A REAL compiler would look up these routines, write code for the variables for the routine to work on, and set up 20's and 4C's for the bare routines in BASIC.

To restore the parser to original form (and allow the area 300-3CF to be freed up for new code) one should CALL -151 into the monitor, and then enter

```

;*
;* EXTENDED PARSER FOR APPLE II
;*
;* BY PAUL R. WILSON
;*
;
;ERASES 1ST 6 BYTES OF PARSER AND REPLACES WITH
;4C 15 03 AND THREE NOP'S
;
; ORG $300
;
;
0300 A94C LDA #$4C
0302 85B1 STA $B1
0304 A915 LDA #$15
0306 85B2 STA $B2
0308 A903 LDA #$03
030A 85B3 STA $B3
030C A9EA LDA #$EA
030E 85B4 STA $B4
0310 85B5 STA $B5
0312 85B6 STA $B6
0314 60 RTS
0315 E6B8 INC $B8 ;RETURN TO BASIC OR PROGRAM
0317 D002 BNE LBLA ;FIRST 6 BYTES
;OF NORMAL
0319 E6B9 INC $B9 ;PARSER CODE
031B A5B8 LDA $B8
031D 8D2803 STA $0328
0320 A5B9 LDA $B9
0322 8D2903 STA $0329
0325 AD0502 LDA $0205
0328 C923 CMP #$23
032A F0DD BEQ LBLC ;IS THE # SIGNAL GIVEN?
032C C925 CMP #$25 ;IF SO, REENTER EXTENDED PARSER
032E D006 BNE LBLB ;IS THE # SIGNAL GIVEN?
0330 A000 LDY $00 ;IF NOT, BACK TO THE BASIC LINE
0332 A923 LDA #$23 ;CHANGE % TO # IN STORING THE LINE IN MEMORY
0334 91B8 STA ($B8),Y
    
```

(Continued)

B1:E6 B8 D0 02 E6 B9 N B1L by hand to patch, and disassemble the parser code and check it for proper restoration.

To save this routine simply type BSAVE EXTENDED PARSER, A\$300, L\$A0 and the disk system will do the rest. Lock the file for safety. A later long file or lack of space may attempt an over-write of an unlocked file.

A program written with extensive use of the extended parser commands will run only with the parser up and running. Otherwise it will crash with SYNTAX ERRORS.

If you carefully enter this as shown above, and save it to disk, you'll be able to use it in many Applesoft programs. I went over the code carefully both in writing it and in transcribing above, so I see no margin for errors. Happy parsing!

Paul R. Wilson is currently employed at Baruch College, NYC, as a lab technician in Natural Sciences. He has found a self-sustaining hobby in home computers and is especially interested in trying to revive LIFELINE on his Apple II.

```

0336 4CB700      LBLB  JMP $00B7      ;BACK TO PARSING THAT LINE:
0339 20B100      LBLC  JSR $00B1      ;TEST FOR CHARACTER FOLLOWING # OR #
033C C953        CMP  'S             ;IS IT AN 'S'?
033E F01B        BEQ  LBLD      ;IF SO, GO TO SCRCCLR
0340 C945        CMP  'E             ;IS IT AN 'E'?
0342 F01D        BEQ  LBLE      ;IF SO, GO TO ENDCCLR
0344 C94C        CMP  'L             ;IS IT AN 'L'?
0346 F01F        BEQ  LBLF      ;IF SO, GO TO LNCLR
0348 C946        CMP  'F             ;F?
034A F021        BEQ  LBLG      ;TO FLASH
034C C949        CMP  'I             ;I?
034E F024        BEQ  LBLH      ;TO INV
0350 C94E        CMP  'N             ;N?
0352 F027        BEQ  LBLI      ;TO NORMAL
0354 C954        CMP  'T             ;T?
0356 F02A        BEQ  LBLJ      ;TO TEXT
0358 4CB100      JMP  $00B1      ;IF NONE OF ABOVE, BACK TO PARSER
035B 2058FC      LBLD  JSR $FC58      ;SCRCCLR--SCREEN GOES DARK
035E 4CB100      JMP  $00B1
0361 2042FC      LBLE  JSR $FC42      ;ENDCLR--CLEARS LINE
0364 4CB100      JMP  $00B1
0367 209CFC      LBLF  JSR $FC9C      ;LNCLR--CLEARS LINE
036A 4CB100      JMP  $00B1
036D A97F        LBLG  LDA #$7F      ;FLASH--OUTPUT INTO FLASH MODE
036F 8532        STA  $32
0371 4CB100      JMP  $00B1
0374 A93F        LBLH  LDA #$3F      ;INV--REVERSE FIELD
0376 8532        STA  $32
0378 4CB100      JMP  $00B1
037B A9FF        LBLI  LDA #$FF      ;NORM--RESET TO NORMAL OUTPUT
037D 8532        STA  $32
037F 4CB100      JMP  $00B1
0382 AD54C0      LBLJ  LDA $C054      ;RESTORES PAGE 1 OF SCREEN ($400-$7FF)
0385 AD51C0      LDA  $C051      ;RESTORES TEXT MODE
0388 AD56C0      LDA  $C056      ;RESTORES PROPER FUNCTION OF LORES GRAPHICS
038B A900        LDA  $900
038D 8520        STA  $20
038F 8522        STA  $22
0391 A928        LDA  #$28
0393 8521        STA  $21
0395 A918        LDA  $18
0397 8523        STA  $23
0399 4CB100      JMP  $00B1
    
```

MICRO

NEW

DOUBLE DOS PLUS
for Apple Computers
\$39.00

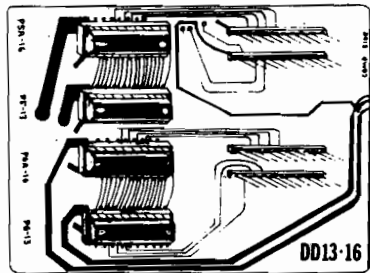

DOUBLE DOS Plus—a piggyback board that plugs into the disk-controller card so that you can switch select between DOS 3.2 and DOS 3.3. Works with the language system eliminating the need in many cases to boot the BASICs disk. Also eliminates the chore of converting all of your 3.2 disks to 3.3

WHY IS DOUBLE DOS Plus better?

- Nothing needs to be soldered, just plug in and go.
- Since all four ROMs are used, all software will work, even early 3.1 DOS.
- Because the ROMs fit on the back of the board, it has the thinnest configuration allowing full use of slot #7
- One set of ROMs is powered up at a time, thus saving power.
- Full 90-day warranty from TYMAC.

NOTE: APPLE is a registered trademark of APPLE Computer, Inc., Cupertino, CA. DOUBLE DOS Plus requires APPLE DOS ROMS

OTHER UNIQUE PRODUCTS FROM MICRO-WARE DISTRIBUTING INC.

- THE APPLE CARD**—Two sided 100% plastic reference card for the Apple computer. Loaded with information of interest to all Apple owners \$3.98
- PARALLEL PRINTER CARD**—PPC-100—A Universal Centronics type parallel printer board complete with cable and connector. This unique board allows you to turn on and off the high bit so that you can access additional features in many printers. Use with EPSON, ANADEX, STARWRITER, NEC, SANDERS, OKI, and other with standard Centronics configuration \$139.00

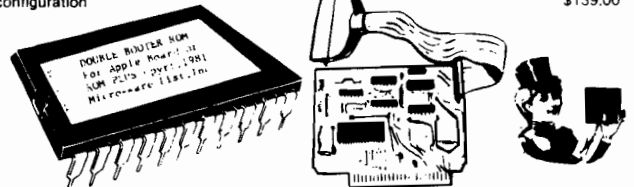

- THE DOUBLE BOOTER ROM**—Plugs into the empty D8 Socket on the Apple motherboard or the Integer ROM Card to provide a 13 sector boot without using the BASICs Disk DoubleBooster may also be used in the MOUNTAIN HARDWARE ROM PLUS board. This chip will not work in a plus machine unless it contains an integer board or a ROM Plus board \$29.00
- DISK STIX**—Contains 10 dozen diskette labels with either 3.3 or 3.2 designation. Room for program names and type also \$3.98
- ***** SOFTWARE *****
- SUPER SEA WAR**—Hires battleship type simulation \$13.95
- ULTIMATE XFER**—A telephone software transfer program, uses DC Hayes Assoc. micromodem \$25.00
- ROAD RALLYE**—Hires driving game with 5 different full screen tracks \$15.00
- MISSILE CHALLENGER**—Hires arcade type game where you defend your cities from falling missiles. 8-levels & writes name & high score to disk \$19.95
- SUPER PIX**—Hires screen dump for the EPSON MX-80, inverse or normal, larger than full page graphics in 2 orientations. Needs Tymac PPC-100 Printer board or we will upgrade your EPSON board for \$25 \$39.95
- GRAPH-FIT**—A hires graphing program that produces bar charts, pie charts and line graphs. Has auto scaling feature too \$25.00

MICRO-WARE
DISTRIBUTING INC.
P.O. BOX 113
POMPTON PLAINS, N.J. 07444
201-839-3478
DEALER INQUIRIES INVITED!!



SEARCH

This program is appropriately entitled SEARCH. It is a utility routine designed to aid in writing and editing programs in Integer BASIC.

R.C. Merten
12307 Oak Street
Omaha, Nebraska 68144

This program's main function is to input a string of characters, variables, punctuation, etc. Then, search through the BASIC program in memory and print to the current output device any numbered lines in which a match has been found.

Several similar programs are available either commercially or in the literature. The problem is that most of them are used with Applesoft, or that special care and handling must be taken to separate the ASCII strings from tokenized material.

SEARCH can be used only on systems with Integer BASIC and the Sweet-16 interpreter in ROM. A language card loaded with Integer BASIC can also be used. It can be used with printers or any version DOS without modification. DOS does not have to be reconnected after running.

The program will make comparisons exactly as they would be printed during a listing of the program (including leading and trailing blanks). It will also find control characters (*i.e.*, control D) scattered throughout the program.

To use SEARCH, first load it in \$300 to \$3F4 and then type 300G from monitor level, or CALL 768 from BASIC. The screen will prompt you with ENTER STRING. Type in the characters to be searched for and hit RETURN. The program will print each numbered line in which a match is found. If you wish to stop the display

from scrolling off the screen, push any key. Subsequently, pushing the space bar will display one line at a time. Pushing RETURN will abort the search program and return to BASIC.

SEARCH uses the Sweet-16 interpreter, and since many assemblers cannot handle these instructions, a hex dump has been provided. Using the Sweet-16 to handle 16-bit numbers reduces the equivalent amount of 6502 code used by 60 to 70 percent.

How the Program Works

When called, SEARCH uses the NXTCHR routine to enter your string into the standard input buffer starting at

\$200. If the only character you enter is a carriage return, the program immediately aborts and returns to BASIC. Normally, though, it starts building an array at \$2000. The array contains the beginning addresses of all the BASIC program lines.

Next, it saves the output hooks and replaces them with a pointer to the subroutine called CATCH. The Integer BASIC LIST routine at \$E04B is called and every listed character is sent to CATCH instead of the screen. CATCH checks each character as it is sent and tries to match it to the string that is still sitting in the input buffer. When a match is identified, the address of the last listed character in the BASIC pro-

```

*****
*
*   SEARCH INTEGER BASIC   *
*
*   BY R.C. MERTEN        *
*   11/17/80              *
*
*   REVISED              *
*   11/20/80              *
*
*****
ZERO      EQU   $00
R1        EQU   $01
R2        EQU   $02
R3        EQU   $03
R4        EQU   $04
R5        EQU   $05
R6        EQU   $06
R7        EQU   $07
R8        EQU   $08
LISTW     EQU   $E2
PPL       EQU   $CA
HIMEM     EQU   $4C
CSWL      EQU   $36
CSWH      EQU   $37
BUFF      EQU   $200
LNADD     EQU   $2000
FOUND     EQU   $2800
CATCH1    EQU   $27F0
LENGTH    EQU   $27F1
HOLD      EQU   $27F2
YSAV      EQU   $27F4
KBSTB     EQU   $C010
KBD       EQU   $C000
CROUT     EQU   $FD8E
COUT      EQU   $FDED
LIST      EQU   $E04B
LISTIT    EQU   $E06D
NXTCHR    EQU   $FD75
SW16      EQU   $F689

```

(Continued)

gram can now be found at \$E2 and \$E3. This address is put into the array called FOUND which starts building at \$2800.

When LIST is finished, the output hooks are returned to their original values. Sweet-16 is again called to determine which line # the FOUND variable belongs in. The beginning address of that line # is placed in \$E2 and \$E3 and LISTIT (\$E06D) is called to print that line to the screen. A short delay follows, along with a check to see if a key has been pushed, and the program continues. At the end, Integer BASIC is reentered through the warm start routine at \$E003.

For those who would like to expand on this program, the routines can easily be adapted to other purposes. For instance, it is sometimes quite handy for BASIC programmers to insert disallowed commands such as HIMEM, LOMEM or DELETE into a BASIC program. Finding the HEX address of the command within the program is difficult, especially if it is not near the start of the program. With these routines and a little ingenuity, finding the exact location in memory of any command can quite easily be found.

The SEARCH seems to be quite bulletproof with one exception. If an Integer program contains an assembly language routine this will sometimes cause it to hang up. The problem could have been corrected but it would make the SEARCH program greater than one page long.

If page 3 is already in use the SEARCH program can easily be relocated to any other portion of memory. There are, however, five locations that must be changed by hand if you are not using an assembler. These locations are one load and two jump instructions at \$30A, \$328 and \$3AB. Also the pointers to the catch routine which are set up at \$359 and \$35D must be changed.

Hope you find what you're SEARCH-ing for.

For about the last 10 years Richard Merten has explored the electronics field both as a job and hobby. He is employed by the Union Pacific Railroad in the Communications Department. He bought his Apple about two years ago and has enjoyed designing both hardware and software for it. Some of his projects include his own version of a 16K expansion board and a totally programmable RS-232 communicative interface card, and a facsimile interface to allow both transmission and reception of Apple's Hi-Res screens.

Address	Hex	Label	Instruction	Comment
0300:	20 8E FD		JSR CROUT	
0303:	A2 0C		LDX #*0C	
0305:	A0 00		LDY #*00	
0307:	8C F0 27		STY CATCH1.	* ZERO INPUT COUNT
030A:	B9 E8 03		LDA TABLE.Y	* PRINT
030D:	09 80		ORA #*80	
030F:	20 ED FD		JSR COUT.	
0312:	C8		INY	
0313:	CA		DEX	
0314:	D0 F4		BNE PRINT.	* NEXT LETTER
0316:	20 8E FD		JSR CROUT.	
0319:	20 75 FD		JSR NXTCHR.	
031C:	8E F1 27		STX LENGTH.	
031F:	A9 00		LDA #*00	
0321:	8D 10 C0		STA KBSTB.	* CLEAR STROBE
0324:	E0 00		CPX #*00	
0326:	D0 03		BNE OVER.	
0328:	4C B5 03		JMP DONE.	
032E:	20 89 F6	OVER	JSR SW16.	** LINE # ARRAY **
032E:	12 CA 00		SET R2 PPL.	
0331:	13 4C 00		SET R3 HIMEM.	
0334:	17 00 20		SET R7 LNADD.	
0337:	63		LDD #R3.	
0338:	33		ST R3.	* GET HIMEM
0339:	62		LDD #R2.	* FIRST LINE ADD
033A:	32		ST R2.	
033B:	31		ST R1.	* SAVE FOR LATER
033C:	D3	LOOP1	CPR R3.	* AT END OF PROG?
033D:	03 07		BC OUT.	
033F:	77		STD #R7.	* LINE ADD. ARRAY
0340:	42		LD #R2.	* GET INDEX
0341:	A1		ADD R1.	* MAKE NEW ADD.
0342:	32		ST R2.	* SAVE IT
0343:	31		ST R1.	* SAVE FOR LATER
0344:	01 F6		EQ LOOP1.	
0346:	23	OUT	LD R3.	* HIMEM TO ARRAY
0347:	77		STD #R7.	
0348:	17 00 28		SET R7 FOUND	* SETUP ARRAY
034B:	16 00 00		SET R6 ZERO.	* FOUND COUNTER
034E:	00		RTN	
034F:	A5 36		LDA CSWL.	* SAVE CSWL HOOK
0351:	8D F2 27		STA HOLD.	
0354:	A5 37		LDA CSWH.	
0356:	8D F3 27		STA HOLD+1	
0359:	A9 BD		LDA #<CATCH.	* POINT TO CATCH
035B:	85 36		STA CSWL.	
035D:	A9 03		LDA #>CATCH.	
035F:	85 37		STA CSWH.	
0361:	20 4B E0		JSR LIST.	* LIST TO CATCH
0364:	AD F2 27		LDA HOLD.	* RESTORE HOOK
0367:	85 36		STA CSWL.	
0369:	AD F3 27		LDA HOLD+1	
036C:	85 37		STA CSWH.	
036E:	20 89 F6		JSR SW16.	** PRINT LINES **
0371:	26		LD R6.	* DONE IF ZERO
0372:	06 40		BZ DONE1.	
0374:	17 00 20		SET R7 LNADD.	
0377:	12 00 00		SET R2 ZERO.	* FOR COMPARASON
037A:	13 00 28		SET R3 FOUND.	* START OF ARRAY
037D:	63	LOOP3	LDD #R3	* GET FOUND ADD.
037E:	34		ST R4.	* HOLD
037F:	67	LOOP2	LDD #R7.	* ADD. NEXT LN
0380:	D4		CPR R4.	
0381:	02 FC		BNC LOOP2.	
0383:	C7		POPD #R7.	* BACKUP TWO
0384:	C7		POPD #R7.	
0385:	D2		CPR R2.	
0386:	06 29		BZ SAME.	
0388:	32		ST R2.	
0389:	18 E2 00		SET R8 LISTW.	
038C:	78		STD #R8.	* ADD OF LINE#
038D:	00		RTN	
038E:	20 6D E0		JSR LISTIT.	* OUTPUT LINE
0391:	A9 00		LDA #*00	
0393:	20 A8 FC		JSR WAIT.	
0396:	AD 00 C0		LDA KBD.	
0399:	10 13		BPL AROUND.	
039B:	A9 00		LDA #*00	
039D:	8D 10 C0		STA KBSTB.	
03A0:	AD 00 C0	LOOP4	LDA KBD.	

APPLE II*
SOFTWARE FROM
POWERSOFT

PEGASUS

(a PASCAL based data base system)

PEGASUS—is a filing and retrieval system using the PASCAL programming language providing a general means for storing data in an orderly fashion. PASCAL code runs three to five times faster than BASIC code designed for a similar application.

Data stored in the PEGASUS data base may be modified, retrieved, and formatted into convenient reports. Three types of data are supported: character, real, and integer. Each PEGASUS data base record may contain up to 20 fields.

Data may be entered either interactively from the console or as a batch from a text file. Records may be modified after they have been entered or deleted from the data base entirely. PEGASUS may also be used to select groups of records based on the values of one or more fields. Output may be to the CRT screen, a printer or a text file. Thus, PEGASUS may be used to create printed reports, examine data on-line, or interface with the input or output of other PASCAL programs. Requirements: Apple II, Plus, or III and two 5¼" disk drives. Or an 8" or Winchester type drive. USCD Pascal Language System 5¼" Disk Only/\$199.95

INCOME STATEMENT SYSTEM

INCOME STATEMENT SYSTEM—(Summarized Reports including Budget Figures Based on Super Checkbook III transactions)—An excellent program complement to SUPER CHECKBOOK III. The system provides for up to 100 income and expense codes. For each code the system maintains a total for the current month, current budget, current year-to-date, and three prior year-to-dates. Income codes may have up to six corresponding expense codes. A "sort code" feature allows account codes to print in a user defined sequence.

Updates to the accounts include current month, end-of-month, and end-of-year. Gross and Net Income Statements may be printed in either account code or sort code sequence. The Account Master File List may be printed by sort code, account code, or alphabetically by account name. Detailed transactions for each code are printed and totaled, one code per page, in code number order.

This system is designed to run in conjunction with the SUPER CHECKBOOK III program described below. Requirements: 48K, two disk drives, printer card, Applesoft Disk Only/\$49.95

SUPER CHECKBOOK III

SUPER CHECKBOOK III—A vastly improved version of our popular selling program. With new features such as: simplified but powerful transaction entry and modification routines, new reconciliation routines, additional features such as 30 percent increase in the total number of checks handled, posting of interest from interest bearing checking accounts, automatic teller transactions, bullet proof error handling, and smart disk routines. Plus the program still contains the options of bar graphs, sorting, activities, and account status. See INCOME STATEMENT SYSTEM described above.

Disk Only/Applesoft \$49.95

Dealer Inquiries Invited

Visa and MasterCard, Check or Money Order include \$2.00 for shipping and handling. C.O.D. \$2.00 additional.

*Apple II and Applesoft are the registered trademarks of APPLE COMPUTER INC.

POWERSOFT

P. O. BOX 157
PITMAN, NEW JERSEY 08071
(609) 589-5500

03A3:	C9 A0		CMP	M*AO	
03A5:	F0 07		BEQ	AROUND.	
03A7:	C9 8D		CMP	M*8D.	
03A9:	D0 F5		BNE	LOOP4.	
03AB:	4C B5 03		JMP	DONE.	
03AE:	20 89 F6	AROUND	JSR	SW16.	** BACK AGAIN **
03B1:	F6	SAME	DCR	R6.	* REDUCE COUNT
03B2:	07 C9		BNZ	LOOP3.	
03B4:	00	DONE1	RTN		
03B5:	A2 00	DONE	LDX	M*00	
03B7:	8E 10 C0		STX	KBSTB.	
03BA:	4C 03 E0		JMP	RESTART.	
03BD:	8C F4 27	CATCH	STY	YSAV.	
03C0:	AC F0 27		LDY	CATCH1.	
03C3:	D9 00 02		CMP	BUFF,Y	
03C6:	D0 17		BNE	CLEAR.	
03C8:	C8		INY		
03C9:	CC F1 27		CPY	LENGTH.	
03CC:	F0 07		BEQ	SETIT.	
03CE:	8C F0 27		STY	CATCH1.	
03D1:	AC F4 27		LDY	YSAV.	
03D4:	60		RTS		
03D5:	20 89 F6	SETIT	JSR	SW16.	** LOAD ARRAY **
03D8:	12 E2 00		SET	R2 LIST#.	
03DB:	62		LDD	BR2.	* ADD FROM BASIC
03DC:	77		STD	BR7.	* INTO FOUND ARRAY
03DD:	E6		INR	R6.	* INCREASE COUNT
03DE:	00		RTN		
03DF:	A0 00	CLEAR	LDY	M*00	
03E1:	8C F0 27		STY	CATCH1.	* ZERO STRING COUNT
03E4:	AC F4 27		LDY	YSAV.	
03E7:	60		RTS		
03E8:	45 4E 54	TABLE	ASC	'ENTER STRING'	
03F4:	00		BRK		

CBM/PET? SEE SKYLES ... CBM/PET?

"You mean this one little Disk-O-Pro ROM will give my PET twenty-five new commands?"

And for just \$75.00? Why, that's only \$3.00 a command!"

The Disk-O-Pro in any PET with Version III (BASIC 2.0) ROMs (### COMMODORE BASIC ###) will give 19 software compatible disk instructions*: 15 identical with the new BASIC 4.0 (or with 8032 ROMs) compatible with both old and new DOS. Plus 4 additional disk commands...including appending (MERGE), overlaying (MERGE #) and PRINT USING, allowing formatting output of strings and numbers on the PET screen or on any printer.

*NOTE: Old DOS doesn't recognize three of the commands.

Those are just 3 of the important commands—and there are 7 more beauties—on your Disk-O-Pro that have never been available previously to PET/CBM users. (Skyles does it again!)... Beauties like the softtouch key (SET) which allows you to define a key to equal a sequence of up to 80 keystrokes; like SCROLL whereby all keys repeat as well as slow scrolling and extra editing features; like BEEP which allows you to play music on your PET.

The Disk-O-Pro is completely compatible with the BASIC programmer's Toolkit. The chip resides in the socket at hexadecimal address \$9000, the rightmost empty socket in most PETS. And for the owners of "classic" (or old) PETS, we do have interface boards.

(For those owning a BASIC 4.0 or 8032, even though the Disk-O-Pro may not be suitable, the Command-O is. Just write to Skyles for additional information. Remember, we have never abandoned a PET owner.)

Complete with 84-page manual written by Greg Yob...who was having so much fun that he got carried away. We had expected 32 pages.

Skyles guarantees your satisfaction: if you are not absolutely happy with your new Disk-O-Pro ROM chip, return it to us within ten days for an immediate full refund.

Disk-O-Pro from Skyles Electric Works.....\$75.00

Complete with interface board (for "classic" PETS)..... 95.00

Shipping and Handling.....(USA/Canada) \$2.50 (Europe/Asia) \$10.00

California residents must add 6%/16½% sales tax, as required.



Skyles Electric Works
231E South Whisman Road
Mountain View, California 94041
(415) 965-1735

Visa/Mastercard orders: call tollfree
(800) 227-9998 (except California).
California orders: please call (415)
965-1735.

Applesoft Error Messages from Machine Language

The methods and data required to utilize Applesoft error messages in assembly language are presented. Use of these routines should be limited to assembly language routines that are interfaced with Applesoft programs.

Steve Cochard
P.O. Box 236
Boyetown, Pennsylvania 19512

Did you ever wonder how Applesoft generates its error messages? While writing an assembly language program that interfaced with Applesoft I found I needed more than just the simple "Syntax Error", which was the only one I knew how to utilize.

I started my search for the "errors" by looking at the machine code for the "Syntax Error" message which is located at \$DEC9. It consists of only two commands:

```
LDX #$10
JMP $D412
```

This short routine, it seemed, was intended only to load the X register with the starting address of the word "SYNTAX" in a table of all error messages. This deduction proved true, and with a little more searching in the \$D412 routine the table was found.

The error message table is located at \$D260 and is 240 bytes long. By loading the X register with the appropriate index and then jumping to the \$D412 routine, it is possible to utilize any error message from machine language or Applesoft.

Table 1 shows the values to be loaded into the X register to generate any of the available 17 messages. Listings 1 and 2 show very short machine and Applesoft programs to verify that this is true. Listing 3 shows a program that will list the entire table.

It should be noted that this procedure, if utilized in machine language, performs exactly as if the error had occurred in an Applesoft program. The error message is printed, the "bell" rings, the last executed line number is printed and the program stops. If an "ONERR GOTO" statement had been executed previously, the program will again operate as if the error had occurred in Applesoft, the object line of the "ONERR GOTO" will be jumped to and executed. Happy Errors!

Table 1

Value of X register	Error message
0	NEXT WITHOUT FOR
16	SYNTAX
22	RETURN WITHOUT GOSUB
42	OUT OF DATA
53	ILLEGAL QUANTITY
69	OVERFLOW
77	OUT OF MEMORY
90	UNDEF'D STATEMENT
107	BAD SUBSCRIPT
120	REDIM'D ARRAY
133	DIVISION BY ZERO
149	ILLEGAL DIRECT
163	TYPE MISMATCH
176	STRING TOO LONG
191	FORMULA TOO COMPLEX
210	CAN'T CONTINUE
224	UNDEF'D FUNCTION

Listing 1: Enter from the monitor to interface with program listing 2.

```
300:LDX $0306
303:JMP $D412
```

Listing 2: Applesoft program to print error messages.

```
10 INPUT "WHAT VALUE OF X ? ";X
20 POKE 784,X
30 CALL 768
```

Listing 3: This short program will list the entire table. Enter it from the monitor and then type in 300G.

```
300:LDX #$00
302:LDA $D260,X
305:EOR #$80
307:BMI $0310
309:ORA #$80
30B:JSR $FDED
30E:LDA #$8D
310:JSR $FDED
313:INX
314:CPX #$FF
316:BNE $0302
318:RTS
```

Steve Cochard is one of the principals of Scientific Software, the author of the "Scientific Software Sweet 16 Assembler." He is a structural engineering supervisor with a large Engineering/Construction firm. Current activities with the Apple computer include development of Structural Analysis and Design systems, various machine language utilities, and a machine language floating point array/matrix manipulation package for use with Applesoft BASIC.

MICRO



VersaWriter

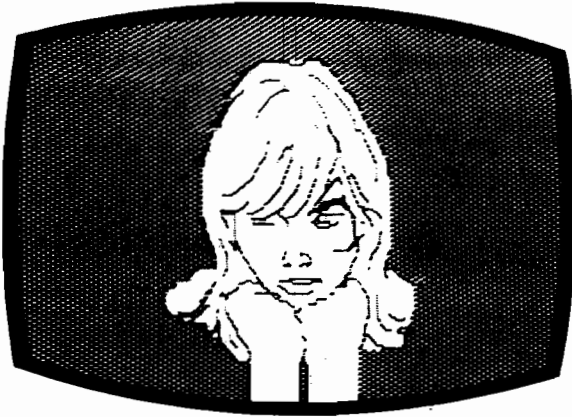

What is VersaWriter?

■ VersaWriter is an inexpensive drawing tablet for the APPLE II that lets you trace a picture and have it appear on TV display.

■ VersaWriter is a comprehensive software drawing package which lets you color in drawings with over 100 different colors.

■ VersaWriter is a shape compiler that converts anything on the screen automatically into a standard shape table.

■ VersaWriter is a text writer for labeling pictures with text in six colors and five sizes. Use English or Greek, upper or lower case letters.

■ VersaWriter is much more! Draw with brush, create schematic drawings, compute area and distance, edit pictures, save, recall and more.



VersaWriter requires ROM APPLESOFT and 48K memory.

\$299 Suggested Retail

UNIQUE OFFER

Send us YOUR disk and \$1. We will promptly return the disk with a slide package of 10 color pictures drawn with VersaWriter.

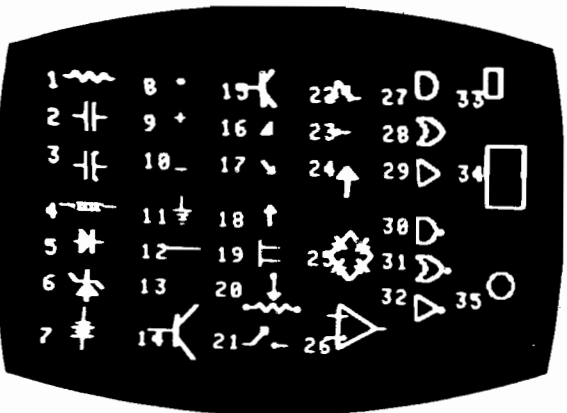

- Enclosed is \$1 and my disk. Send me the slide package.
- Send more information including VersaWriter dealers in my area.

DEALER INQUIRIES INVITED.

NAME _____

ADDRESS _____

CITY _____ STATE _____ ZIP _____

Send To: Versa Computing, Inc. • 887 Conestoga Circle • Newbury Park, CA 91320 • (805) 498-1956

Trick DOS

Apple DOS obviously is a live entity. It was created by a supreme being at Cupertino to mystify, amaze and tantalize us common folk. Let us literally turn the tables!

Sanford M. Mossberg
50 Talcott Road
Port Chester, N.Y. 10573

On booting a disk, the DOS command table (DCT) comes to reside at RAM locations \$A884-\$A908 (decimal 43140-43272). The last letter of each of the 28 DOS commands is represented by a high byte ASCII character which signals the end of the command. Other letters or numerals are written in low byte code. A zero marks the end of the DCT. Armed with these simple facts, we can trick DOS 3.2 or 3.3 into obeying our whims and desires.

Listing 1 provides code for TRICK DOS. Following initialization (lines 2000-2060) and optional instructions (lines 2500-2670), a menu is presented (lines 600-710), each item of which is analyzed:

1. *Display Current DOS Command Table:* The heart of the entire program is found in the subroutine at lines 100-180. The starting location (START) of the table never changes. Lines 120-130 search successive memory locations in the DCT until a zero byte is found. The end address of the table, not including the zero byte, is assigned to the variable FIN. Line 140 initializes the array DOS\$(*,*), the contents of which are noted in line 102. Lines 150-180 PEEK DCT locations, fill the two-dimensional matrix and create a string (DOS\$) which contains every character in the DCT. Subsequently, the array variables will be used to format screen display (lines 860-880 and 1060-1070), and the string variable will be manipulated to alter the command table by POKEing data into RAM. The displayed DCT may be listed to a printer (see figure 1).

Figure 1: Current DOS Commands and Addresses

DEC	HEX		DEC	HEX	
43140	A884	INIT	43206	A8C6	APPEND
43144	A888	LOAD	43212	A8CC	RENAME
43148	A88C	SAVE	43218	A8D2	CATALOG
43152	A890	RUN	43225	A8D9	MON
43155	A893	CHAIN	43228	A8DC	NOMON
43160	A898	DELETE	43233	A8E1	PR#
43166	A89E	LOCK	43236	A8E4	IN#
43170	A8A2	UNLOCK	43239	A8E7	MAXFILES
43176	A8A8	CLOSE	43247	A8EF	FP
43181	A8AD	READ	43249	A8F1	INT
43185	A8B1	EXEC	43252	A8F4	BSAVE
43189	A8B5	WRITE	43257	A8F9	BLOAD
43194	A8BA	POSITION	43262	A8FE	BRUN
43202	A8C2	OPEN	43266	A902	VERIFY

2. *Change DOS Command Table:* The program block starting at line 1000 first outputs current commands by utilizing the routine described earlier. The command to be changed (OC\$) is requested in line 1080. Since keyboard input is in low byte code, the high bit of the final letter is turned on (line 1090). The validity of the command is checked in line 1100 and variable PT marks the position of the command in the array. An invalid command triggers an error message (line 1110) and returns the user to the prior input request. The replace-

ment command (NC\$) is solicited in line 1130 and high byte conversion occurs in line 1140. The subroutine at lines 400-500 rearranges the DCT. Commands preceding and following the changed command are contained in T1\$ and T3\$, respectively; the new command is placed in T2\$. In line 460, DOS\$ is recreated by concatenation of the above-noted strings. Lines 470-500 POKE the new command table into memory. An incidental, but important, feature of this entire section, and others, is the effective error trapping (lines

1080, 1110, 1120, 1130, 1170, 1180, 1210 and 1240) which prevents potential crashing of the program and assures professionally formatted screen display.

3. Restore Normal DOS Command Table and

4. Try Sandy's Commands: Data statements in lines 2100-2110 contain ASCII code for the normal DCT. Line 1330 reads the data into the variable NDOSS\$. A sample table which I have found useful is coded in lines 2120-2130. Line 1340 produces MYDOSS\$. Lines 1380-1390 replace the resident DCT with either of these strings, thus restructuring the entire command table rapidly.

5. Exit Program: At program termination all text and graphics modes should be normalized. Line 1510 accomplishes this by successively turning off Hi-Res, turning on text page one, clearing the keyboard strobe and setting a full text window. Although TRICK DOS does not require these steps, the habit is a good one to cultivate. After the program ends, the new command table will remain viable in RAM until rebooting occurs or power is discontinued. If you so desire, the new DCT can be preserved permanently by initializing a disk.

Knowing that DOS intercepts and reviews all commands before the Applesoft interpreter can process the command, several admonitions are appropriate. Each newly-created DOS command should have a character set that does not duplicate the first letters of any Applesoft BASIC command. To better understand this pitfall, imagine that we have changed "LOAD" to "L" and "RENAME" to "RE". Now, if we type "LIST" or "LEFT\$", DOS understands this to mean LOAD (L=LOAD) the file "IST" or "EFT\$", and the "FILE NOT FOUND" error message is returned. Typing "REM" would produce the same error message as DOS attempted to RENAME (RE=RENAME) the non-existent file "M." So far this is annoying but not harmful.

Consider the dire results from changing "INIT" to "I." Any Applesoft command beginning with an "I" would promptly start initializing the disk. This would be catastrophic and must be avoided! For the reasons cited above, I advise you to peruse a list of Applesoft BASIC commands before modifying a DOS command. Changing "LOAD" to "LD", "RENAME" to "RNM" and "INIT" to "I" would have avoided the

chaos. Choice #4 from the menu will create a table of "safe" commands that I have found to be functional.

When you begin using a newly created DCT, mistakes will be inevitable and error messages will proliferate. The DCT commands "LOAD" and "SAVE" are special, in that they also exist as Applesoft commands to a cassette recorder. If either is used erroneously, the system will hang. Only by pressing "RESET" can you recover. If you do not have autostart ROM, altering these two commands may be more of a nuisance than an aid.

Experiment freely and enjoy your newfound power over DOS.

Sandy Mossberg is a physician who had no computer experience until he purchased an Apple II in February, 1980. His obsession is programming. He writes a monthly column for his computer club's publication *The APPLESARE Newsletter*. The column is entitled, "Basic Tips and Technics" and deals with many aspects of Applesoft programming and DOS function.

Listing 1

```

10 REM TRICK DOS
    BY SANDY MOSSBERG
20 TEXT : CALL - 936: POKE - 1
    6298,0: POKE - 16300,0: POKE
    - 16368,0
30 GOSUB 2010: GOSUB 3010: GOSUB
    2510: GOTO 610
100 REM
    PEEK COMMAND TABLE
    AND CREATE ARRAY
102 REM ARRAY DOS$(R1-28,C1-2)
    C1=COMMAND
    C2=START ADDR
104 REM DOS$=DOS COMMAND TABLE
106 REM DOS=ADDR COMMAND TABLE
110 TM = START
120 IF PEEK (TM) = 0 THEN FIN =
    TM - 1: GOTO 140: REM FIND
    END OF TABLE
130 TM = TM + 1: GOTO 120
140 I = 1: FOR J = 1 TO 29: FOR K
    = 1 TO 2:DOS$(J,K) = "": NEXT
    K,J:DOS$(1,2) = STR$(START
    ):DOS$ = "": REM INITIALIZE
150 FOR DOS = START TO FIN
160 IF PEEK (DOS) > 127 THEN DOS$(I,1)
    = DOS$(I,1) + CHR$( PEEK (DOS)
    ):DOS$ = DOS$ + CHR$( PEEK (DOS)
    ):DOS$((I + 1),2) = STR$(DOS + 1
    ):I = I + 1: GOTO 180: REM IF HI
    BYTE INCR I
170 DOS$(I,1) = DOS$(I,1) + CHR$(
    ( PEEK (DOS)):DOS$ = DOS$ +
    CHR$( PEEK (DOS))
180 NEXT DOS: RETURN
    
```

```

300 REM
    DEC --> HEX
310 HD% = DOS / 256: NBR = HD%: GOSUB
    340: HB$ = HEX$
320 LD% = FN MOD(DOS): NBR = LD%:
    GOSUB 340: LB$ = HEX$
330 HEX$ = HB$ + LB$: RETURN
340 H% = NBR / 16 + 1: L% = NBR /
    16: L = L% * 16: L% = NBR - L +
    1
350 HEX$ = MID$(H$,H%,1) + MID$(
    (H$,L%,1): RETURN
400 REM
    REORGANIZE
    COMMAND TABLE
410 IF PT = 1 THEN TT$ = "": GOTO
    430
420 TT$ = LEFT$(DOS$, VAL (DOS$
    (PT,2)) - START)
430 FOR I = 1 TO LEN (NC$): T2$ =
    T2$ + MID$(NC$,I,1): NEXT
440 IF PT = 28 THEN T3$ = "": GOTO
    460
450 T3$ = RIGHT$(DOS$,FIN + 1 -
    VAL (DOS$((PT + 1),2)))
460 DOS$ = TT$ + T2$ + T3$: T2$ =
    ""
470 DOS = START
480 FOR I = 1 TO LEN (DOS$): POKE
    DOS, ASC ( MID$(DOS$,I,1)):
    DOS = DOS + 1: NEXT
490 FIN = FIN + LEN (NC$) - LEN
    (OC$)
500 POKE FIN + 1,0: RETURN
600 REM
    MENU
610 HOME :TT$ = "=====
    ": GOSUB 3110
620 TT$ = "TRICK DOS MENU": GOSUB
    3110
630 TT$ = "=====": GOSUB
    3110
640 VTAB 6: PRINT "1.DISPLAY CUR
    RENT DOS COMMAND TABLE.": PRINT
650 PRINT "2.CHANGE DOS COMMAND
    TABLE.": PRINT
660 PRINT "3.RESTORE NORMAL DOS
    COMMAND TABLE.": PRINT
670 PRINT "4.TRY SANDY'S COMMAND
    S.": PRINT
680 PRINT "5.EXIT PROGRAM.": PRINT
    : PRINT
690 VTAB 17: CALL - 958: PRINT
    " WHICH CHOICE? ": GET I
    $: PRINT I$: CH = VAL (I$)
700 IF CH < 1 OR CH > 5 OR I$ =
    "" THEN 690
710 ON CH GOTO 800,1000,1300,130
    0,1500
800 REM
    DISPLAY CURRENT TABLE
810 HOME :TT$ = "=====
    =====": GOSUB 31
    10
820 TT$ = "CURRENT DOS COMMANDS &
    ADDRESSES": GOSUB 3110
830 TT$ = "=====
    =====": GOSUB 3110
840 IF NOT FF THEN VTAB 8: INVERSE
    :TT$ = " READING DOS COMMAND
    TABLE ": GOSUB 3110: NORMAL
    
```

```

850 GOSUB 110: VTAB 4: CALL - 9
58
860 PRINT : HTAB 2: INVERSE : PRINT
"DEC";: HTAB 8: PRINT "HEX";
: HTAB 22: PRINT "DEC";: HTAB
28: PRINT "HEX": NORMAL : PRINT

870 FOR I = 1 TO 14
880 PRINT DOS$(I,2) " ";DOS = VAL
(DOS$(I,2)): GOSUB 310: PRINT
HEX$ "DOS$(I,1);: HTAB 21: PRINT

DOS$(I + 14,2) " ";:DOS = VAL
(DOS$(I + 14,2)): GOSUB 31
0: PRINT HEX$ "DOS$(I + 14
),1): NEXT
890 IF FF THEN FOR I = 1 TO 5: PRINT
: NEXT : RETURN
900 VTAB 22: PRINT "LIST TABLE T
O PRINTER (Y/N) ? ";: GET I$
910 IF I$ = "Y" THEN FF = 1: HTAB
1: CALL - 998: CALL - 958:
PRINT B$: INVERSE : PRINT "
TURN PRINTER ON AND PRESS A
NY KEY ": PRINT : HTAB 10: PRINT
" EXPECT A PAUSE ";: GET I$:
PRINT : NORMAL : PRINT D$;D
OS$(20,1);1: GOSUB 810:FF =
0: PRINT D$;DOS$(20,1);0: GOTO
610
920 IF I$ = "N" THEN 610
930 HTAB 1: GOTO 900
1000 REM

CHANGE TABLE

1010 HOME :TT$ = "=====
=" : GOSUB 3110
1020 TT$ = "CHANGE COMMANDS": GOSUB
3110
1030 TT$ = "=====": GOSUB
3110
1040 VTAB 4: CALL - 958: VTAB 8
: INVERSE :TT$ = " READING D
OS COMMAND TABLE ": GOSUB 31
10: NORMAL
1050 GOSUB 110: VTAB 5: CALL -
958
1060 FOR I = 1 TO 7
1070 PRINT DOS$(I,1);: HTAB 10: PRINT

DOS$(I + 7,1);: HTAB 20: PRINT
DOS$(I + 14,1);: HTAB 30: PRINT

DOS$(I + 21,1): NEXT
1080 VTAB 14: CALL - 958: INPUT
"TYPE COMMAND TO BE CHANGED:
";OC$: IF OC$ = "" THEN 118
0
1090 OC$ = MID$(OC$,1, LEN (OC$
) - 1) + CHR$( ASC ( RIGHT$(
(OC$,1)) + 128): REM TURN HI
BIT ON IN LAST LETTER OF
COMMAND
1100 FOR I = 1 TO 28: IF OC$ = D
OS$(I,1) THEN PT = I: GOTO 1
130: REM PT=POINTER TO
POSITION OF COMMAND IN ARRAY

1110 IF I = 28 THEN PRINT B$: VTAB
16: INVERSE : PRINT " NOT A
VALID CURRENT COMMAND ": NORMAL
: FOR J = 1 TO 3000: NEXT : GOTO
1080
1120 NEXT I
1130 VTAB 16: CALL - 958: INPUT
"TYPE NEW COMMAND: ";NC$: IF
NC$ = "" THEN 1130
1140 NC$ = MID$(NC$,1, LEN (NC$

```

```

) - 1) + CHR$( ASC ( RIGHT$(
(NC$,1)) + 128): REM TURN HI
BIT ON IN LAST LETTER OF
COMMAND
1150 PRINT B$: VTAB 18: HTAB 3: PRINT
"CONFIRM (Y/N) ? ";: GET I$:
PRINT I$
1160 IF I$ = "Y" THEN VTAB 20: INVERS
E : PRINT " WRITING COMMAND TABLE
": GOSUB 410: VTAB 18: HTAB
1: CALL - 958: PRINT " CHAN
GE COMPLETED ": NORMAL : GOTO
1220
1170 IF I$ < > "N" THEN VTAB 1
8: CALL - 958: GOTO 1150
1180 VTAB 18: CALL - 958: PRINT
: PRINT "RETURN TO MENU OR T
RY AGAIN (M/A) ? ";: GET I$:
PRINT I$
1190 IF I$ = "A" THEN GOTO 1080

1200 IF I$ = "M" THEN 610
1210 GOTO 1180
1220 VTAB 20: CALL - 958: PRINT
"ANOTHER CHANGE (Y/N) ? ";: GET
I$: PRINT I$: IF I$ = "Y" THEN
1040
1230 IF I$ = "N" THEN 610
1240 GOTO 1220
1300 REM

RESTORE NORMAL TABLE OR
INSTALL SANDY'S TABLE

1310 VTAB 20: INVERSE : PRINT "
WRITING COMMAND TABLE ";
1320 NDOSS$ = "":MYDOS$ = ""
1330 FOR I = 1 TO 132: READ D:ND
OSS$ = NDOSS$ + CHR$( D): NEXT
: RESTORE
1340 FOR I = 1 TO 67: READ D:MYD
OSS$ = MYDOS$ + CHR$( D): NEXT
: RESTORE
1350 DOS = START
1360 IF CH = 3 THEN IM$ = NDOSS$:
TT$ = " NORMAL DOS COMMAND T
ABLE REESTABLISHED ":FIN = S
TART + LEN (NDOSS$) - 1
1370 IF CH = 4 THEN IM$ = MYDOS$:
TT$ = " SANDY'S COMMAND TAB
LE INSTALLED ":FIN = START +
LEN (MYDOS$) - 1
1380 FOR I = 1 TO LEN (IM$): POKE
DOS, ASC ( MID$( IM$,I,1)):D
OS = DOS + 1: NEXT
1390 POKE FIN + 1,0
1400 HTAB 1: PRINT TT$: NORMAL :
GOSUB 3210: HTAB 1: GOTO 69
0
1500 REM

END PROGRAM

1510 POKE - 16298,0: POKE - 16
300,0: POKE - 16368,0: TEXT
: HOME
1520 VTAB 10: INVERSE :TT$ = " E
ND OF TRICK DOS PROGRAM ": GOSUB
3110: NORMAL
1530 VTAB 15: PRINT " INITIALIZI
NG A DISK BEFORE REBOOTING":
PRINT "WILL PRESERVE THE CU
RRENT DOS COMMANDS"
1540 VTAB 22: END
2000 REM

INITIALIZE

2010 DIM DOS$(30,2)

```

```

2020 D$ = CHR$(4):B$ = CHR$(7
):SS$ = "
": REM 21 SPACES
2030 H$ = "0123456789ABCDEF"
2040 DEF FN MOD(X) = X - INT (
X / 256) * 256: REM SIMULATE
MOD FUNCTION
2050 START = 43140: REM START OF
TABLE
2060 RETURN
2100 DATA 73,78,73,212,76,79,65,
196,83,65,86,197,82,85,206,6
7,72,65,73,206,68,69,76,69,8
4,197,76,79,67,203,85,78,76,
79,67,203,67,76,79,83,197,82
,69,65,196,69,88,69,195,87,8
2,73,84,197,80,79,83,73,84,7
3,79,206,79,80,69,206,65,80,
80,69,78,196
2110 DATA 82,69,78,65,77,197,67,
65,84,65,76,79,199,77,79,206
,78,79,77,79,206,80,82,163,7
3,78,163,77,65,88,70,73,76,6
9,211,70,208,73,78,212,66,83
,65,86,197,66,76,79,65,196,6
6,82,85,206,86,69,82,73,70,2
17: REM NORMAL TABLE
2120 DATA 73,170,76,196,83,214,8
2,85,206,67,72,206,68,204,76
,203,85,76,203,67,211,82,196
,69,88,195,87,210,80,83,206,
79,208,65,208,82,69,206,67,6
5,212,77,206,78,77,206,80,16
3,73,163,77,65,216,70,208,73
,78,212,66,211,66,204,66,210
,86,69,210
2130 DATA 77,206,78,77,206,80,16
3,73,163,77,65,216,70,208,73
,78,212,66,211,66,204,66,210
,86,69,210: REM
SANDY'S TABLE
2500 REM

INSTRUCTIONS

2510 HOME :TT$ = "=====":
GOSUB 3110
2520 TT$ = "INSTRUCTIONS": GOSUB
3110
2530 TT$ = "=====": GOSUB
3110
2540 VTAB 7: CALL - 958: PRINT
"DO YOU WANT INSTRUCTIONS (Y
/N) ? ";: GET I$: PRINT I$: IF
I$ = "N" THEN RETURN
2550 IF I$ < > "Y" THEN 2540
2560 POKE 34,4: VTAB 5: CALL -
958
2570 PRINT "1.THE DOS COMMAND TA
BLE RESIDES AT RAM": PRINT "
LOCATIONS $A884 TO $A908 (
DEC 43140": PRINT " TO 4327
2)": PRINT
2580 PRINT "2.EACH COMMAND IS RE
PRESENTED BY ASCII": PRINT "
CHARACTER CODES. ONLY THE
LAST LETTER": PRINT " OF A
COMMAND HAS THE HIGH BIT ON
SO": PRINT " THAT DOS CAN R
ECOGNIZE THE END OF THE"
2590 PRINT " COMMAND. NOTE THE
EXAMPLES BELOW: PRINT : PRINT
" LOAD = 4C 4F 41 C4": PRINT
" INIT = 49 4E 49 D4": PRINT
" RUN = 52 55 CE": PRINT
: PRINT
2600 PRINT "3.ZERO MARKS THE END
OF THE TABLE."

```

```

2610 GOSUB 3210: HOME
2620 PRINT "4.THIS PROGRAM WILL
ENABLE YOU TO ALTER": PRINT
" THE COMMAND TABLE. YOU MA
Y DESIRE TO": PRINT " CHANG
E 'CATALOG' TO "; INVERSE :
PRINT "CAT";: NORMAL : PRINT
" OR 'SAVE' TO "; PRINT " "
:: INVERSE : PRINT "SV";: NORMAL

2630 PRINT ". BE SURE THAT YOUR
NEW DOS COMMAND": PRINT " D
OES NOT DUPLICATE THE FIRST
PART OF": PRINT " AN APPLES
OFT BASIC COMMAND, OTHERWISE
": PRINT " UNUSUAL EVENTS M
AY OCCUR. EXPERIMENT!"

2640 PRINT " TIREDNESS OR SILLI
NESS MAY RESULT IN": PRINT "
WEIRD SYMBOLS!!!": PRINT

2650 PRINT "5.THESE MODIFICATION
S WILL TRIGGER A": PRINT "
SYNTAX ERROR IF A DIRECT OR
DEFERRED": PRINT " COMMAND
UTILIZES 'NORMAL' TERMINOLOG
Y."

2660 PRINT "6.": INVERSE : PRINT
"TRICK DOS";: NORMAL : PRINT
" IS MENU-DRIVEN AND SELF-":
PRINT " PROMPTING. HAVE FU
N!!!"

2670 POKE 34,0: GOSUB 3210: RETURN

3000 REM

TITLE PAGE

3005 REM SF APPLE CORE FORMAT

3010 INVERSE : VTAB 4
3020 TT$ = SS$: GOSUB 3110: GOSUB
3110
3030 TT$ = " TRICK DOS
": GOSUB 3110
3040 TT$ = SS$: GOSUB 3110: GOSUB
3110
3050 TT$ = " BY SANDY MOSSBERG
": GOSUB 3110
3060 TT$ = SS$: GOSUB 3110: GOSUB
3110: NORMAL
3070 VTAB 16:TT$ = "CUSTOMIZE YO
UR SET OF DOS COMMANDS!": GOSUB
3110
3080 GOSUB 3210: RETURN
3100 REM

PRINT CENTER

3110 WIDTH = 20 - ( LEN (TT$) / 2
): IF WIDTH < = 0 THEN PRINT
TT$: RETURN
3120 HTAB WIDTH: PRINT TT$: RETURN

3200 REM

CONTINUE/END

3210 VTAB 23: HTAB 12: PRINT "[E
SC] TO END"
3220 VTAB 24: PRINT TAB( 8);"[S
PACE] TO CONTINUE ";
3230 PRINT "[ ]": HTAB 29: GET
ZZ$: IF ZZ$ = CHR$( 27) OR
ZZ$ = CHR$( 3) THEN TEXT :
HOME : GOTO 1510
3240 IF ZZ$ = CHR$( 32) THEN RETURN

3250 CALL - 868: CALL - 1008: GOTO
3230: REM

```

MICRO

New Publications

(Continued from page 74)

Programming Languages; Elements of BASIC (Line Numbers Revisited, Blank Spaces, Variables, Arrays, Expressions); BASIC Statements (Remarks, Assignment Statements, Declaring Array and String Size, Branch Statements, Loops, Subroutine, Conditional Execution, Input and Output Statements, Halting and Resuming Program Execution); Functions (Numeric Functions, String Functions, System Functions, User-Defined Functions, Function Nesting). *Advanced BASIC Programming—Direct Access and Control* (Memory and Addressing); Using Peripheral Devices; Program Output and Data Entry (More About the PRINT Statement, PRINT Formatting Functions, Cursor Control and Special Video Effects, Text Windows, The CHR\$ Function: Programming Characters in ASCII, Programming Data Entry, Forms Data Entry, Formatting Output, Programming Printers); Storing Data on Cassette; Program Optimization (Faster Programs, Compact Programs); Debugging; Immediate and Programmed Mode Restrictions. *The Disk II—*(About Disks, How Data is Stored on Disks, Locating Tracks and Sectors, Write Protecting); The Disk Operating System (Versions of DOS, Initializing Disks, Disk Files, Diskette Directory, Track/Sector List, Disk Crash); Booting the Disk II (How to Boot DOS); Beginning Disk Commands (CATALOG, LOAD, The Disk Version of the RUN Command, Specifying the Drive Number, Slot Specification, Volume Specification); More Disk II Commands (INIT, SAVE, DELETE, LOCK, UNLOCK, RENAME, VERIFY); Using DOS Commands in Programs; Using Disk Files (Using Sequential Files, How to Append to Sequential Files, The POSITION Command, Using Random-Access Files, A Practical Random-Access Example, The Byte Parameter); Other DOS Commands (EXEC, MAXFILES, Using DOS Debugging Aids); Machine Language (Binary Image) Disk Files (BSAVE, BLOAD, BRUN). *Graphics and Sound—Low-Resolution Graphics* (Setting Up the Graphics Page, Graphics Programming Statements); High-Resolution Graphics (Which Page Should You Use?, Setting Up the Graphics Display, Alternatives to HGR and HGR2, High-Resolution Colors, Plotting Points and Lines); Using High-Resolution Shapes (Defining Shapes, Assembling the Shape Table, Entering the Shape Table, Shape Drawing Commands); Apple II Sound (Operating the Speaker). *Machine Language Monitor—*(Accessing the Monitor, Leaving the Monitor); Functions of the Monitor (Examining the Microprocessor Registers, Altering Memory, Altering the Microprocessor Registers, Saving and Retrieving Memory with Apple II Peripherals, Moving and Comparing Blocks of Memory, The GO Command, Using the Printer, The Keyboard Command, Setting Display Modes, Eight-Bit Binary Arithmetic Using the Monitor, User-Definable Monitor Command); The

Mini-Assembler (Accessing the Mini-Assembler, Monitor Commands in the Mini-Assembler, Leaving the Mini-Assembler, Instruction Formats, Using the Mini-Assembler, Disassembled Listings, Testing and Debugging Programs, Integrating Your Program with BASIC). *Compendium of BASIC Statements and Functions—*(Immediate and Programmed Modes, BASIC Versions, Nomenclature and Format Conventions); Statements (listed alphabetically); Functions (listed alphabetically). *Appendices: A.* Derived Numeric Functions; *B.* Editing Commands; *C.* Error Messages (Integer BASIC Error Messages, Applesoft Error Messages, DOS Error Messages); *D.* Intrinsic Subroutines; *E.* Useful PEEK and POKE Locations; *F.* BASIC Reserved Words (Integer BASIC, Applesoft, DOS); *G.* Memory Usage (General Memory Organization, The BASIC Language Interpreters, DOS Memory Requirements, Integer BASIC Memory Usage, Applesoft Memory Usage); *H.* Disk II Format (The Track/Sector List, The Directory); *I.* ASCII Character Codes and Applesoft Reserved Word Tokens; *J.* Hexadecimal-Decimal Integer Conversion Table; *K.* Bibliography; *L.* Screen Layout Forms. *Index.*

General Computer

Computer/Law Journal is a quarterly which began publication in 1978. It is published by the Center for Computer/Law (P.O. Box 54308 T.A., Los Angeles, California 90054). The journal covers such subjects as Patent Protection for Computer Software; Computer-Assisted Legal Research; Current Developments in Computer Law; Computer-Related Evidence Law; Electronic Funds Transfer Systems; and Computer Crime. Back issues are available. An annual subscription is \$60.00 per volume in the U.S. and Canada, elsewhere \$64.00. ISSN: 0164-8756.

Bio-Medical

Medical Computer Journal: The Journal for Computers in Clinical Practice is a quarterly publication of the Doctor's Computer Club (42 East High Street, East Hampton, Connecticut 06424). It is supplemented by a quarterly newsletter called *Dr. Com Puter's Report*. The journal averages 24 pages per issue and the newsletter 4 pages. The journal covers such subjects as clinical practice, laboratory, ECG, X-ray, and system description. Both the journal and newsletter publish software programs. Subscription rates are \$15.00 for members, \$25.00 for organizations and anyone outside North America, and \$10.00 for students and physicians in training.

Sorting with Applesoft

Applesoft BASIC makes special demands which often severely degrade the efficiency of a theoretically efficient sorting algorithm. This article presents Applesoft BASIC code for a sorting algorithm which avoids most of these special problems. Thus, this algorithm may be the best one to use in programs which require a large amount of sorting.

Norman P. Herzberg
32 Gulick Road
Princeton, New Jersey 08540

No, this is not another article on Shell's sort, or Heap sort. If you thought it was, then this article probably is just what you've been looking for.

Sorting alphanumeric data on the Apple using Applesoft BASIC can be very painful, because of "the dreaded garbage collection." As the Applesoft interpreter encounters string variables, it fills memory with the values of these strings, even though there may be only a few variables receiving these values. In a surprisingly short time memory is filled with old discarded string values (garbage). Once memory is full, Applesoft will 'tidy things up' throwing out all the garbage (outdated data) that has accumulated, so that only the current value remains for each variable in the program. In the worst cases this will take several minutes of computing time, even though the entire procedure is carried out in machine language. Forcing garbage collection, by calling the Applesoft function FRE(0) before memory gets full is of no help. The time it takes to perform the FRE function seems only to depend on the complexity and size of the string arrays in a program, not on the amount of garbage that has accumulated.

One requirement of an ideal sorting program for Applesoft is clear. I would like to sort without ever referring to any

```

1 REM          SORT DEMO
3 REM          NORMAN P. HERZBERG
4 REM
10 GOTO 1010
500 REM        SORT SUBROUTINE
510 FOR I = 0 TO NR - 1: S(I) = I + 1: NEXT : S(NR) = 0
520 START = 1: IF NR < 2 THEN 700
530 F = 1: TM = 0: I = S(0)
540 IF L > 1 THEN 650: REM SORT ON VALUE
550 FOR DX = 0 TO 1: IF I < = 0 THEN 580
555 C = I: T1 = 0: US = I: UP = I * I = S(I): IF I < = 0 THEN 575
560 FOR JJ = 0 TO 1: IF N$(I,S) < N$(C,S) THEN S(T1) = I: T1 = I: GOTO 57
    0
565 S(UP) = I: UP = I
570 I = S(I): JJ = (I < = 0): NEXT
575 S(UP) = I: S(T1) = - US: I = S(0): GOTO 590
580 IF F THEN F = 0: START = S(0)
585 I = - I: S(TM) = I: TM = I: I = S(I)
590 DX = (I = 0): NEXT
595 GOTO 700: REM NOW MOVE THE DATA
650 FOR DX = 0 TO 1: IF I < = 0 THEN 680
655 C = VAL (N$(I,S) + " ") : T1 = 0: US = I: UP = I: I = S(I): IF I < = 0 THEN
    675
660 FOR JJ = 0 TO 1: IF VAL (N$(I,S) + " ") < C THEN S(T1) = I: T1 = I: GOTO
    670
665 S(UP) = I: UP = I
670 I = S(I): JJ = (I < = 0): NEXT
675 S(UP) = I: S(T1) = - US: I = S(0): GOTO 690
680 IF F THEN F = 0: START = S(0)
685 I = - I: S(TM) = I: TM = I: I = S(I)
690 DX = (I = 0): NEXT
700 S(0) = ABS (START)
710 PRINT " SORTING": REM NOW REARRANGE THE DATA
720 I = S(0): FOR JJ = 1 TO NR: R(JJ) = I: I = S(I): NEXT
730 FOR I = 1 TO NR: S(R(I)) = I: NEXT
740 FOR J = 1 TO NR - 1: FOR I = 1 TO NH: & N$(J,I), N$(R(J),I): NEXT
750 TEMP = R(J): R(S(J)) = TEMP: R(J) = JS(TEMP) = S(J): S(J) = J
760 NEXT J
800 PRINT G$">>>>> SORTED"
810 PRINT "PRESS SPACE-BAR TO CONTINUE " : GET Z$: RETURN
1000 REM        INITIALIZATION
1010 D$ = CHR$(4): G$ = CHR$(7): TEXT : HOME
1020 VTAB 10: HTAB 15
1030 PRINT "SORT DEMO "
1040 GOSUB 5010: REM &-STRING SWAP INITLZ. !! DESCRIBED IN CALL A.P
    .P.L.E. JAN. 1980 PG. 37
1050 NR = 50: NH = 2: REM 50 LONG FILE WITH 2 FIELDS
1060 DIM N$(NR,NH), R(NR), S(NR), H$(2): REM HEADER ARRAY H$ IS ONLY FOR
    THE DEMO
1070 H$(1) = "NAME": H$(2) = "ADDRESS"
1080 FOR I = 1 TO NR: C$ = "": N% = RND (1) * 26 + 193: C$ = C$ + CHR$(N
    %): N% = RND (1) * 26 + 193: C$ = C$ + CHR$(N%): N$(I,1) = C$: NEXT
1090 FOR I = 1 TO NR: N% = RND (1) * 9 + 1: N$(I,2) = STR$(N%): NEXT
1500 REM        MAIN LOOP
1510 TEXT : HOME : PRINT
1520 PRINT "_____ SORT DEMO _____"
1530 PRINT "1. LIST DATA "
1540 PRINT "2. SORT DATA "
1550 PRINT "3. EXIT "

```

(Continued)

```

1560 PRINT : INPUT "WHICH # ? (1,2,3) ? ";Z$:Z = VAL (Z$ + " ")
1570 IF Z < 1 OR Z > 3 THEN 1560
1580 IF Z = 3 THEN PRINT "O.K.": END
1590 ON Z GOSUB 3010,2010
1600 GOTO 1510
2000 RENS OR T
2010 MF = 1: GOSUB 4510
2020 INPUT "ENTER # OF FIELD FOR SORT ";S$:S$ = S$ + " ":S = VAL (S$): IF
S < 1 OR S > NH THEN 2020
2030 PRINT : PRINT "DO YOU WANT TO SORT:": PRINT
2040 PRINT "1 ALPHABETICALLY"
2050 PRINT "2 NUMERICALLY"
2060 PRINT " OR"
2070 PRINT "3 EXIT "
2080 PRINT " (SORTING TAKES ABOUT "10 + INT (.15 * NR * LOG (NR))" SE
C.):": PRINT
2090 INPUT "WHICH # ";L$:L$ = L$ + " ":L = VAL (L$)
2100 IF L < 1 OR L > 3 THEN 2090
2110 IF L = 3 THEN RETURN
2120 PRINT : PRINT "SORTING ";: GOSUB 510
2130 RETURN
3000 REM REPORT
3010 HOME
3020 PRINT "REPORTING N$ IN FORM (NAME,ADDRESS) ": PRINT
3030 XX = 0
3040 FOR I = 1 TO NR:XX = XX + 1: IF XX = 5 THEN XX = 1: PRINT
3050 PRINT "(";
3060 FOR H = 1 TO NH - 1: PRINT N$(I,H);",";: NEXT
3070 PRINT N$(I,H);") ";
3080 NEXT I
3090 PRINT
3100 VIAB 23: PRINT "PRESS SPACE-BAR TO CONTINUE ";: GET Z$
3110 RETURN
4500 REM SUB MENU
4510 HOME : PRINT "SELECT FROM:": PRINT
4520 IF MF = 0 THEN PRINT "O "H$(0)
4530 FOR I = 1 TO NH: PRINT I" "H$(I): NEXT I: PRINT
4540 RETURN
5000 REM &-STRING SWAP
5010 FOR I = 810 TO 855: READ PP: POKE I,PP: NEXT
5020 CALL 810
5030 RETURN
5040 REM MACHINE LANGUAGE POKES
5050 DATA 169,76,141,245,3,169,58,141,246,2,169,3,141,247,3,96,32,227,22
3,133,132,124,32,190,222,32,227,223,160,2,177,133,72,177,131,145,133
,104,145,131,136,16,143,96,0,

```

string arrays at all, and if that is impossible, I certainly want to avoid garbage collection. I was motivated to find such a sorting algorithm while trying to improve the File Cabinet data management program provided through Apple's Software Bank. For this program to be any real use, it should be possible to sort through a list of some 100-odd addresses in a reasonable amount of time.

One tool for accomplishing this appeared in the January 1980 issue of *Call A.P.P.L.E.* On page 37 appeared a String-Swap subroutine which generates no extra garbage strings at all! See lines 5000-5060 for the routine, and line 740 for its use. (The Ampersand calls the routine.) Using this routine and a crude exchange sort would seem to be the way to avoid most of the garbage collection problem. However, I have no grudge against garbage collection itself, only the large amount of time it takes. A poor exchange sort algorithm wastes more time than it saves.

My next idea was to adopt Shell's sort and the String-Swap subroutine. The key requirement is to continue to avoid the garbage collection problem. This can be accomplished by sorting an alphanumeric array as a linked list, rearranging the links rather than the items themselves. If one then walks from link to link, one travels through the list in order. Of course most people want to sort *their* data, not data in a form someone else decides they should have collected. And where are the links in File Cabinet? The answer is, although there may be no links connecting the data we have, these links can be easily created.

Suppose the array to be sorted is called N(I,J)$ where $I = 1, \dots, NR$, $J = 1, \dots, NH$. All you need do is create an array R of dimension NR , and set $R(I) = I$. Now $R(I)$ points to the I -th item on the list. Instead of exchanging the elements N(I,J)$ one need only change the values of the pointers $R(I)$. At the end of the sorting process, one can then

use the String-Swap routine to move the data into place without any string storage overhead. I actually did this, but found a new source of dissatisfaction. Shell's sort, and Quick sort too for that matter, are not 'stable' sorts. This means that if I sort an address list by last name, and then by state, the names within each state will no longer be in alphabetical order.

Recently I came across an article describing a variant of Quick sort that is stable. It is this algorithm which I will discuss below. The data to be processed must be augmented by a set of links S , rather than with pointers R . To implement this sorting algorithm we start by creating an array S , where $S(I) = I + 1$ for $I = 0, \dots, NR - 1$, and $S(NR) = 0$. The element $S(I)$ points to the item that comes *after* item I . The initial list item is pointed to by $S(0)$, and so initially is 1. The value 0 in $S(NR)$ indicates that there is nothing following item NR . The list can now be sorted by changing the values in the S array. After the list has been sorted, if the smallest item was the K -th on the original list, then $S(0) = K$, and $S(K)$ will point to the next smallest item, and so on. The relationship between the S links and the R pointers is given by the algorithm in line 720 in the program below. As you will note, in line 730 we replace the values in array S , which have served their purpose, with the values of the inverse of the function R . These backward pointers will be used in the actual process of rearranging the array N(I,H)$, without ever using any other string array. (See line 750.)

The code itself is quite opaque, and I can do no more than refer the interested reader to the original paper: B. Cheek, "A Fast and Stable List Sorting Algorithm," *The Australian Computer Journal*, vol. 12, no. 2, May 1980.

There are two misprints in that paper, one trivial, and one not so trivial. In the line corresponding to my lines 575,675 the paper omits the minus sign in front of US (which is called *uperstrt* in the paper). Cheek also omits taking the absolute value of $START$: line 700.

Cheek gives timing estimates which show that this algorithm is as good as Quick sort. The 'disadvantage' of requiring the creation of linking fields is, for us, a great advantage, and the fact that it is a stable sort makes me believe it is the proper one to use in any Applesoft application where more than a couple of dozen items need be sorted.

The sample program that illustrates this algorithm has been set up so that it may easily be modified for inclusion as a

part of File Cabinet. You may want to change the names of some of the arrays if you use it as a module in another program. The sorting is done in the subroutine at lines 500-810. Lines 500, 710, and 800 may be omitted, and line 810 replaced with 810 RETURN. The actual sorting algorithm appears twice, in lines 550-590, where alphabetic data is sorted, and in lines 650-690 where numeric data is sorted. (If your data has embedded blanks you will need both sorts. Try comparing "-123" and "+123" "123" and " 23 " and see what Apple-soft thinks.)



The two sections of code are identical except for the use of the VAL function in the second sort routine, and there are other interesting differences. In line 655 we save the value of VAL(N\$(I,S)) as C, and then in the loop starting at line 660, C is compared with new values VAL(N\$(I,S)) until I becomes ≤ 0 . In line 555, however, we do not save the string array N\$(I,S), only the current value of I. In the loop starting at line 560 comparisons are made between N\$(C,S) and N\$(I,S). Thus the index calculation (locating N\$(C,S)) is made in each iteration of the loop. This 'bad' programming practice avoids introducing a string variable C\$, and so avoids producing garbage.

The rest of the program is included just for demonstration purposes. It creates a random list of 50 two-letter names and one-digit addresses. Sorting this list, first by address, and then by name, will demonstrate the speed and stability of the sorting algorithm. The timing estimate is just that, an estimate of the running time. I added 10 seconds for psychological reasons. Note that, as with Quick Sort, it is possible for the sort to take much longer than average. In particular, if the data is already sorted, the running time will be much worse than average. If you fear that this will happen, sort first on some other key to 'randomize' the data before sorting on the key of interest. This will bring the sorting time down to only twice the expected value.

Norman Herzberg is a professional mathematician who has been interested in computing and computers since his undergraduate days at Columbia College. At that time he was introduced to an I.B.M. "computer" that was programmed via a plug board. About 18 months ago he gave up his TI 59 calculator for an Apple, to see what it could do. He invites any and all readers with similar interests to contact him through the SOURCE CL1279.

MICRO

WANTED





SOFTWARE AUTHORS!

for Apple, Atari, TRS-80, NEC, Hitachi. . .

Broderbund Software is looking for new authors to join its international team of programmers. If you have a product for the micro market, let us show you the advantages of working with our team of design, production and distribution specialists.

Call or write for our free Authors Kit today or send us a machine readable copy of your work for prompt review under strictest confidence.



Broderbund Software

Box 3266, Eugene, Oregon 97403 (503) 343-9024

September Brings Apple Graphics!

September *Double* Apple Bonus Features Hi- and Lo-Res Graphics

See these articles in our next issue:

- **True 3-D Images on the Apple II** — Using stereoscopic pairs, users can produce true 3-D images.
- **Shaper Utility Program** — A utility program for managing shape tables.
- **Paddle Hi-Res Graphics** — Shows how to use paddles to create shape tables.
- **Apple Bits** — The first of a series on how to better use the Apple's low-resolution graphics.
- **Lo-Res Graphics and Pascal** — Tells how to use low-resolution graphics with Pascal.

14 Apple Articles!

Besides these attention-getting graphics articles, MICRO's September issue will contain another 9 Apple articles — **14 Apple articles altogether!**



A STATISTICAL ANALYSIS AND FILE MAINTENANCE SYSTEM FOR THE APPLE II™ MICROCOMPUTER

As a Subset Language of P-STAT™ 78...
A-STAT™ 79 computes:

- FREQUENCIES
- BI-VARIATE TABLES - CHI SQUARES
- CORRELATION MATRICES
- MULTIPLE REGRESSION
- RESIDUALS
- APPLE PLOT INTERFACE
- APPLE FILE CABINET INTERFACE
- FILE SORT
- AGGREGATION
- REPORT WRITING
- COMPLETE TRANSFORMATION LANGUAGE
- READS VISICALC FILES

A-STAT™ 79
Uses Standard DOS Text File and EXEC's
48K Version — All programs in Applesoft™

A-STAT™ 79 is available from:
ROSEN GRANDON ASSOCIATES
296 PETER GREEN ROAD
TOLLAND, CONNECTICUT 06084
(203) 875-3541

A-STAT™ 79 on Disk with 95-page manual... **\$125.00**

Apple II™ is a trademark of the Apple Computer Inc.
P-STAT™ 78 is a trademark of P-STAT Inc., Princeton, N.J.
A-STAT™ 79 is copyrighted by Gary M. Grandon, Ph.D.



**SBCS
PUTS
YOU
ON TOP**

Organize your business with
accounting software from SBCS:

- General Ledger
- Accounts Receivable
- Accounts Payable

The above programs can be used alone or integrated. They include extensive error checking and data entry prompting, numerous reports, departmentalizing, and budgeting. Detailed documentation included.

Get on top of things! Call or write today.

SMALL BUSINESS COMPUTER SYSTEMS
4140 Greenwood, Lincoln, NE 68504 (402) 467-1878

FINANCIAL MANAGEMENT SYSTEM

A FAST, EASY TO USE ACCOUNTING SYSTEM DESIGNED FOR HOME AND BUSINESS
Enter an entire month's CHECKING, CHARGE CARD, and CASH accounts in just a few minutes using personalized macro lists. INSTANT ERROR CORRECTION Audit all files by Code and Month with year-to-date totals.

- PERFECT FOR TAX ACCOUNTING
- SELF PROMPTING, ERROR AVOIDING ENTRY SYSTEM with 1 to 3 KEYSTROKE ENTRIES and AUTOMATIC DATE, CODING and NUMBER SEQUENCING.
- Printer routines for listing disk files, balance reconcile, search, and audit reports. Configure program to match almost ANY PRINTER.
- Enter your own ITEM and CODE MACROS, up to 100 each.
- Make specific and expanded searches employing complete use of macro lists.
- 48K with ROM APPLESOFT and DISK required. (printer optional)
- PRICE: 29.95

FINANCIAL MANAGEMENT SYSTEM II

ALL THE ABOVE FEATURES PLUS +

- NEW BUDGET MANAGER - Plan, balance, and review your budget. Then generate COMPLETE reports with summation for any 1 - 12 month period.
- SINGLE or DUAL DISK compatible. Configure program to either disk system.
- PRICE: 39.95

GROCERY LIST

A USEFUL HOUSEHOLD PROGRAM DESIGNED TO ORGANIZE SUPERMARKET SHOPPING
Shoppers will INSTANTLY be able to use this easy, self-prompting program. Scan a file of up to 500 USER DEFINED ITEMS. Choose those needed with a single key-stroke. Then print a shopping list ORGANIZED BY TABLE NUMBER, SECTION, or four letter code such as "DARY", "BAKE" or "DELI."

- 48K APPLE with disk and printer required. (APPLESOFT)
- PRICE: \$19.95

D R JARVIS COMPUTING
1039 CADIZ DR. - SIMI, CA 93065
PHONE (805) 526-0151

Check. VISA or MASTER CARD accepted. DEALER INQUIRIES INVITED

L I S P for the Apple II

Pegasis Systems' new P-LISP interpreter is a full implementation of the well-known Artificial Intelligence language. Written in machine code, this powerful interpreter includes the following features:

- Over 55 functions implemented
- Extensive 45-page User Manual
- Full function trace
- Fast, efficient Garbage Collector
- Supplied with function editor and pretty-printer
- Runs in 32 or 48K Apple II or II+ with disk
- ELIZA and other sample programs included
- Special language card version provided

P-LISP is supplied on disk with User Manual for \$99.95. The manual is available separately for \$10.00. Please specify DOS 3.2 or 3.3.

PEGASYS SYSTEMS, INC.
4005 Chestnut Street
Philadelphia, PA 19104



Orders only: 800-523-0725
PA residents and inquiries: (215) 387-1500

Pennsylvania residents add 6% sales tax
Apple is a trademark of Apple Computer, Inc.



Good software is no longer a myth.



SENSIBLE SOFTWARE, INC. IS PLEASED TO INTRODUCE...
OUR 1981 COLLECTION OF SUPERIOR SOFTWARE FOR THE APPLE COMPUTER...

APPLESOFT-PLUS STRUCTURED BASIC [APLUS] \$25.00

32K +, Disk II, ROM/RAM Applesoft, Apple II/Apple II +
APLUS is a 4K machine language utility that adds the following structured programming commands to Applesoft basic: 1) WHEN..ELSE..FIN, 2) UNTIL, 3) WHILE, 4) UNLESS, 5) CASE, 6) SELECT (variable), and 7) (OTHERWISE). Multi-line IF..THEN statements are also supported. APLUS allows the use of "named" subroutines or "procedures". The programmer can now instruct a program to "DO CURVE-FIT" without worrying about the location of the subroutine. APLUS automatically indents "&LIST"ed programs to clarify the logic flow. The APLUS "&CONVERT" command replaces the above structured programming commands with "GOTO"'s and "GOSUB"'s to provide a standard Applesoft program as output. New programs can now be written using "GOTO"'-less logic.

APPLESOFT PROGRAM OPTIMIZER [AOPT] \$20.00

32 +, Disk II, ROM/RAM APPLESOFT, Apple II/Apple II +
AOPT is a 2.2K machine language utility that will substantially reduce the size of an Applesoft program without affecting the operation of the program. AOPT automatically: 1) Shortens variable names, 2) Removes remarks, 3) Removes unreferenced lines, 4) Appends short lines together, 5) Removes extra colons, and 6) Renumbers line numbers. AOPT will convert a verbose, well documented, development version of a program into a memory-efficient, more secure, production version of the same program. This is the ORIGINAL and the BEST optimizer on the software market today!

DOS PLUS \$25.00

32 +, Disk II, DOS 3.3, Apple II/Apple II +
DOS PLUS is the software solution for living with both 13-sector (DOS 3.1, 3.2, and 3.2.1) and 16 sector (DOS 3.3) Apple diskettes. DOS PLUS adds 8 new commands to Apple DOS. Three of these are built-in and five are user definable. The built in commands include: 1) ".F" to "flip" between DOS 3.2 and 3.3 (The user need not re-boot and any program that resides in memory will not be affected by the flip. The DOS version can even be changed within a program!), 2) ".S" status command informs you what DOS version is currently active, and 3) ".B" BLOAD- analysis is also provided to inform the user of the starting address and length of the last accessed binary file. DOS PLUS also includes a DOS COMMAND CHANGER program to allow easy customization of Apple DOS commands to suit individual tastes.

DISK ORGANIZER II —NEW— \$30.00

48K, Disk II, Apple II/Apple II +
DO II is the fastest and friendliest utility available today for organizing files on an Apple II diskette. DO II provides the following functions: 1) TITLING in Normal, Inverse, Flashing, Lower case, and other characters normally not available, 2) CUSTOM REORDERING of the directory, 3) ALPHABETIZING, 4) DYNAMIC DISPLAY of ALL filenames on a diskette (including deleted files), 5) RENAMING files with the same character options as TITLING, 6) UNDELETING, 7) DELETING, 8) PURGING deleted files, 9) LOCKING (all or some), 10) UNLOCKING (all or some), 11) USE of DOS sectors for increased data storage, and 12) a SIMULATED CATALOG to show the modified directory before it is written to the diskette. DO II is completely MENU DRIVEN and attains it's speed by altering a RAM version of the catalog. DO II uses a very powerful SMART KEY to automatically locate the next valid filename for any specified disk operation. Compatible with DOS 3.1, 3.2, 3.2.1, and 3.3 as well as MUSE DOS to allow manipulation of SUPER TEXT files! (Note: Updates available for \$5.00 and original diskette.)

PASCAL LOWER CASE —NEW— \$25.00

48K +, Disk II, Apple II/Apple II +, Language System
This is the most recent commercially available LOWER CASE MOD for Pascal for the Apple II. It is the only currently available modification that is compatible with both versions of Pascal (1.0 and 1.1). The Pascal version is automatically checked prior to updating system Apple. If you have any of the hardware lower case adapters you can now input the following characters directly from the keyboard: | ~ \ ` ^ & # _ and \. This modification does NOT interfere with any of the 'Control' character functions implemented by the Pascal environment and will 'undo' any alterations made by other commercially released modifications.

QUICKLOADER \$25.00

48K +, Disk II, Apple II/Apple II + . . . (2 Disks)
If you find yourself doing the same things over and over -- QL will help you do it faster! QL is a unique disk that lets you load DOS, a language card (optionally), and an application program of your choice extremely rapidly. QL boots as a 13 or 16 sector diskette and is easy to set up and use. To change the setup, you merely load your Apple RAM with the new data and use the "RECONFIGURE" option of QL. The next time you boot your QL disk, it will quickly load your new setup (Language Card, DOS, Application program) into your Apple! QL can reduce the time to perform these functions by up to 80%! Now that you've read this, you say "But I can already do all of that!" QL doesn't do anything new -- it just does it MORE CONVENIENTLY and FASTER! Try it, you'll like it!

DISK RECOVERY ("THE SCANNER") \$30.00

48K +, Disk II, Apple II/Apple II +
This program is long overdue. You need no longer be concerned with the problem of physically damaged disks. Just as "Apple Pascal" provides a "BAD BLOCK SCAN", DISK RECOVERY will do a complete scan of your Apple diskettes' recording surface. Damaged areas will be "marked" as used in the disk directory so that no attempts will be made to "WRITE" to a bad sector. The VTOC will be completely redone to reflect both the bad sectors and actual disk usage. A complete report is generated advising the user of all corrections. A resulting "DISK MAP" is presented for your review. The greatest advantage of this program over the other versions is that it can be used on either NEWLY INITIALIZED DISKS or disks that ALREADY CONTAIN PROGRAMS as well as the SPEED of analysis. THE SCANNER is fully compatible with both 13 and 16 sector diskettes. This is a must for all Disk II owners!

ALSO AVAILABLE:

- SUPER DISK COPY III \$30.00**
- MULTI-DISK CATALOG III \$25.00**
- THE NEW PROTECTOR \$250.00**
(Call or Write for Information)
- LUNAR LANDER II \$15.00**
- MASTER MAZE \$15.00**

SENSIBLE SOFTWARE, INC.
6619 PERHAM DRIVE / W. BLOOMFIELD, MICHIGAN 48033
313-399-8877

VISA and MASTERCARD WELCOME
Michigan Residents add 4% Sales Tax
Please add \$1.00 postage & handling for each item ordered.

Expanding the Superboard

Build your own expansion board for the OSI Superboard including VIAs, PIAs, a sound chip, and a number of other possibilities.

Jack McDonald
Mews Cottage, Pond Lane
Clanfield, Portsmouth
PO8 0RG, England

Many articles and programs have appeared in computer magazines on AIM, SYM, and KIM systems with their VIAs and PIAs, leaving Superboard out in the cold! To correct this unbalanced situation I built an expansion unit for Superboard, consisting of PIAs and VIAs, with room for the addition of a 'Sound Chip' and further expansion if required.

In an attempt to standardize, I chose the decoded addresses closest to the SYM, because the Superboard doesn't seem to use E000-EFFF. In table 1 you can see that for VIA 1, the SYM's Axxx is equivalent to our Exxx. For example, A00B on the SYM is E00B. This makes it fairly easy to transfer, as the PIA/VIA registers are accessed by the two least significant hex digits (00-FF). On the prototype only a few of the chips were installed — most AIM/SYM applications use two VIAs at most. However, this circuit provides for decoding two PIAs, three 6522 VIAs, a 6532 VIA, a sound chip, and a spare. The 6520's could be used to select other devices. How about an alternative character ROM, or even characters in RAM? I'll leave that to you.

Connection to S/B is via a 40 pin jumper lead. A separate 5V feed to the VIA board is preferred but pin 11 of J1 could be used. Make sure that the Data Bus buffers are fitted to your S/B (U6,U7).

Figure 1

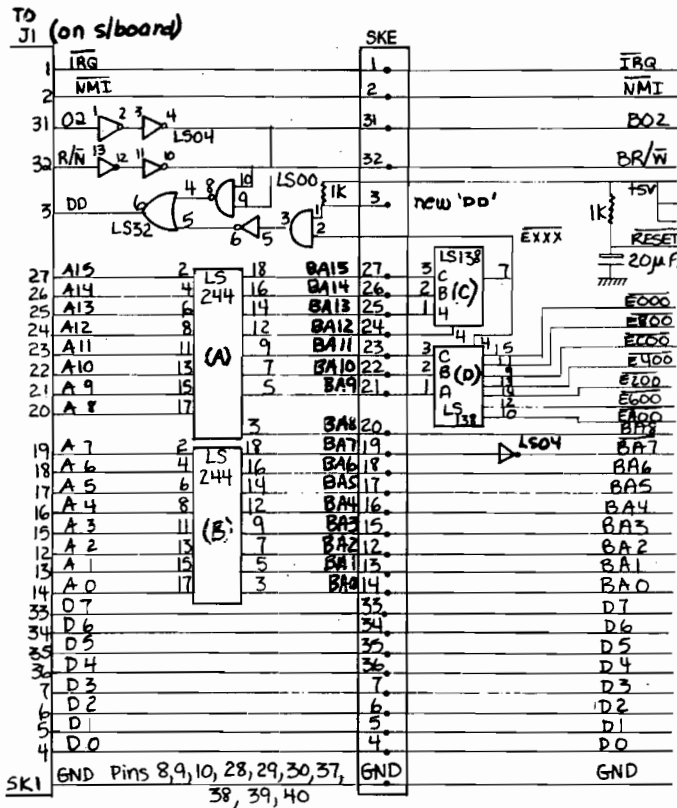

Figure 2: Simple D/A - A/D Voltmeter

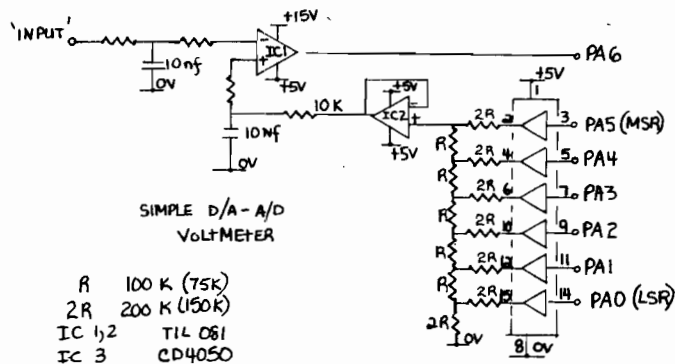

Table 1
6502

SYM/AIM S/Bd

Ab00	Eb00	ORB (PB0-PB7)
Ab01	Eb01	ORA (PA0-PA7)
Ab02	Eb02	DDR B
Ab03	Eb03	DDR A
Ab04	Eb04	T1L-L/T1C-L
Ab05	Eb05	T1C-H
Ab06	Eb06	T1L-L
Ab07	Eb07	T1L-H
Ab08	Eb08	T2L-1/T2C-L
Ab09	Eb09	T2C-H
Ab0A	Eb0A	SR
Ab0B	Eb0B	ACR
Ab0C	Eb0C	PCR(CA1,CA2, CB1,CB2)
Ab0D	Eb0D	IFR
Ab0E	Eb0E	AER
Ab0F	Eb0F	ORA

b is 0 for VIA 1
b is 8 for VIA 2
b is C for VIA 3 (SYM only)

6532

SYM/AIM S/Bd

A400	E400	ORA
A401	E401	DDRA
A402	E402	ORB
A403	E403	DDRB
A404	E404	W-edge detect, R-timer
A405	E405	W-edge detect, R-int flags
A406	E406	W-edge detect, R-timer
A407	E407	W-edge detect, R-int flags
A41C	E41C	TIMER-1T
A41D	E41D	TIMER-8T
A41E	E41E	TIMER-64T
A41F	E41F	TIMER-1024T

Two 74LS244's were used to buffer the 16 address lines, 4/6ths of a 74LS04 buffer the phase two and R/W. Alternatively three 74LS367's could be used. The 74LS32 plus 1/6 74LS04 and 1/2 74LS00 are needed to provide the necessary 'DD' signal to S/B and allow expansion via SKE to a 610 board or whatever. The new 'DD' input was required since open collector OR gates don't exist. Initially three O/C inverters were used.

The 74LS138(A) enables 74LS138(D) for addresses E000-EFFF and (D) decodes in 256-byte segments.

If power-on reset is used, all resets should be connected in parallel. Individual resets with switches can be used with an associated extra wiring "jungle" or use the outputs of a PIA as a software reset.

Figure 3: A/D Interfaces

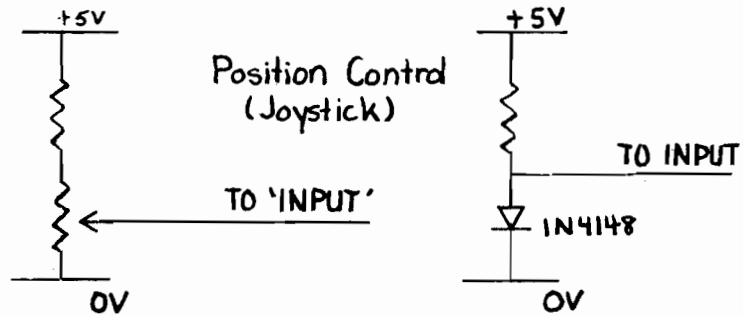

Listing 1

```

;* GENERAL SUCCESSIVE APPROXIMATION
;* TO DRIVE DVM
;*
;* BY JACK MCDONALD
;*
;*PIA = $EXXX
;
;XX, YY, AND AA ARE DETERMINED BY USER
;
INIT   LDA #$3F
        STA PIA                ;SET 6 OUTPUTS & 2 INPUTS
        LDA #$04
        STA PIA+1            ;ACCESS IORA
;
START  LDA #$00
        STA YY                ;CLEAR LOCATION YY
        LDA #$40
        STA XX                ;SET MSB IN LOC XX (BIT 5 FOR OUR D/A)
        LDX #$07
        ;LOAD COUNTER (6 + 1, SINCE WE DEX FIRST)
LOOP   DEX
        BEQ FIN                ;DONE?
        LDA XX
        STA PIA                ;SET MSB ON D/A
;
;DE-GLITCH TIME DELAY
;
DEGL   LDA #$00
        STA AA
DLOOP  DEC AA                ;1ST DEC AA CONTAINS $FF
        BNE DLOOP            ;DELAY FOR $FF X 2 MICROSEC
;
        LDA PIA                ;READ PIA INPUT
        AND #$80                ;ONLY BIT 6 (A/D OUTPUT)
        BNE SAVE
        BEQ NEXT
SAVE   ADC YY                ;STORE RESULT AFTER ADDITION
        STA YY                ;YY HAS TOTAL SO FAR
NEXT   ROR XX                ;NEXT 'MSB'
        JMP LOOP
FIN    LDA YY                ;TAKE FINAL TOTAL
        JSR CRT                ;PRINT IT ON CRT
        JMP START            ;START AGAIN

```

Figure 4: A/D Interfaces

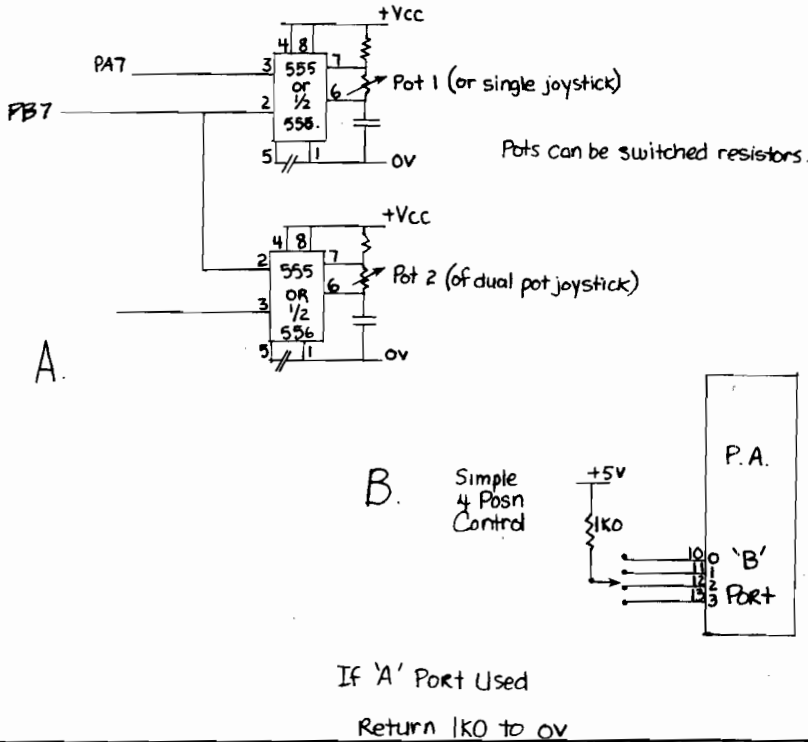

Figure 5

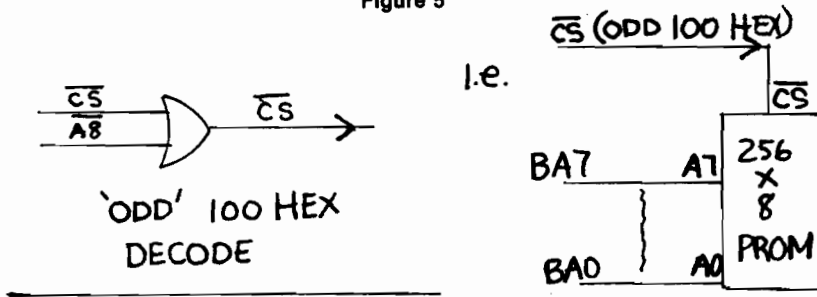
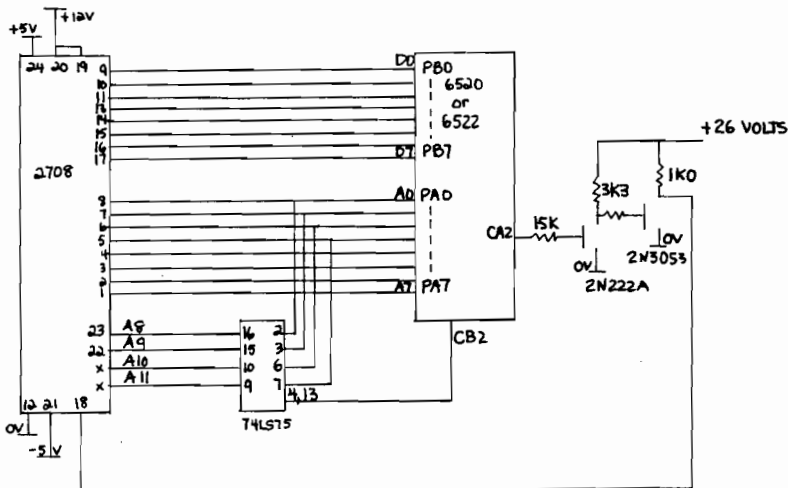

Figure 6: EPROM/PROM Programmer



The expansion board was constructed on 'VERO' DIP Board and the 40 pin sockets were straddled across the two supply rails (see figure 1). In the USA 'VECTOR' is a near equivalent. To make output connections, 16-pin Dill sockets (use only the 8 pins connected to the PA/PB outputs) 'VECTOR' type VCT-4493-1 may be suitable. Wire-wrap/wire pen or Rats Nest can be used with wire-wrap allowing tidier modifications.

Figure 2 shows a simple A/D-D/A converter, which performs the function of a 6-bit digital voltmeter. "De-gitching" has not been included — a software delay is used instead.

Figure 3 gives two very primitive input interfaces for the DVM. Listing 1 is a successive approximation program to drive the DVM. Improvements to the circuits and program are possible at the expense of simplicity, but the circuit is adequate for simple control applications and learning about D/A's in general.

The resistor values should be kept between 150K and 330K for the 2R, to minimize the effect of the 4050 "on" resistance (about 1K). R is two paralleled 2R's.

Figure 4(a) is a simple method of implementing joystick controls. The variable resistor in the timing circuit of the 555/556 alters the duration of the output pulse. This pulse is detected by the PA7 pin of a 6532 VIA in its interrupt mode. The 555 is triggered by the low transition of PB0 on the same device. The software on interrupt reads the timer; then, by using a 'dead zone' and a no-action (or stop), can be defined [i.e., 0-130(up), 131-140(stop), 141-255 (down)]. Thus the stop position is not too critical to locate manually.

Figure 4(b) shows an ultra-simple switch position detector. By reading the four bits, one of four possibilities is detected, i.e. LDA PIA, and #50F — value left in A is the switch number.

Figure 5 indicates the additional decoding for 100 hex 'boundaries' — 256-byte PROMS, etc.

Figure 6 is a commonly used "EPROM programmer" of the on-board variety. The address is first latched into PA0-PA7 and the data byte to be programmed is latched into PB0-PB7. Finally the programming pulse is applied via CA2 for the recommended time. As the 8 bits (PA) will only address 256 bytes, a 74LS75 is used as an address extender. If PA0-PA4 are initially zero then clocking

Figure 7: Sound Generator Interface

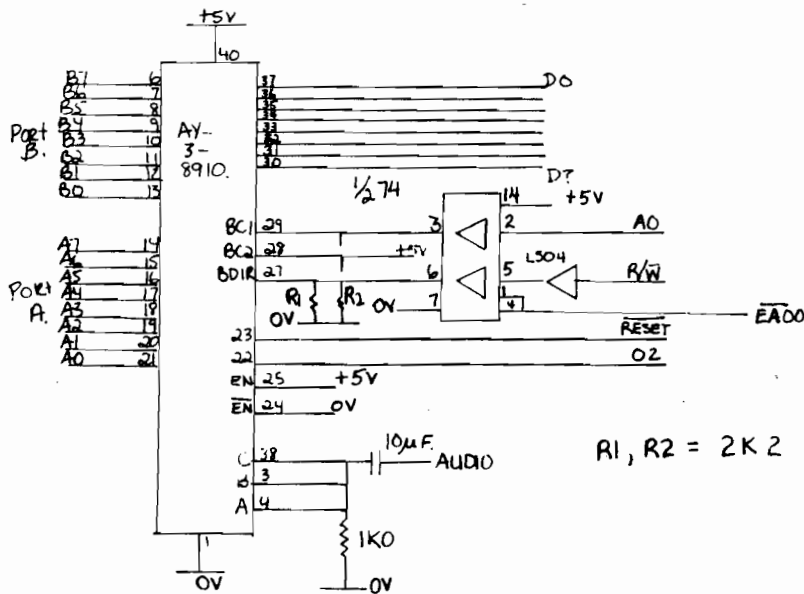

BDIR	BC1	Hex	Dec	Function
0	0	EA00	59904	[READ] INACTIVE
0	1	EA01	59905	READ FROM DSE
1	0	EA00	59904	WRITE DATA TO PSG
1	1	EA01	59905	[WRITE] LATCH ADDRESS

Example: POKE 59905,7 POKE 59904,130 places (DEC) 130 in register 7.

Figure 8: Electro-Mechanical Paper Tape Reader

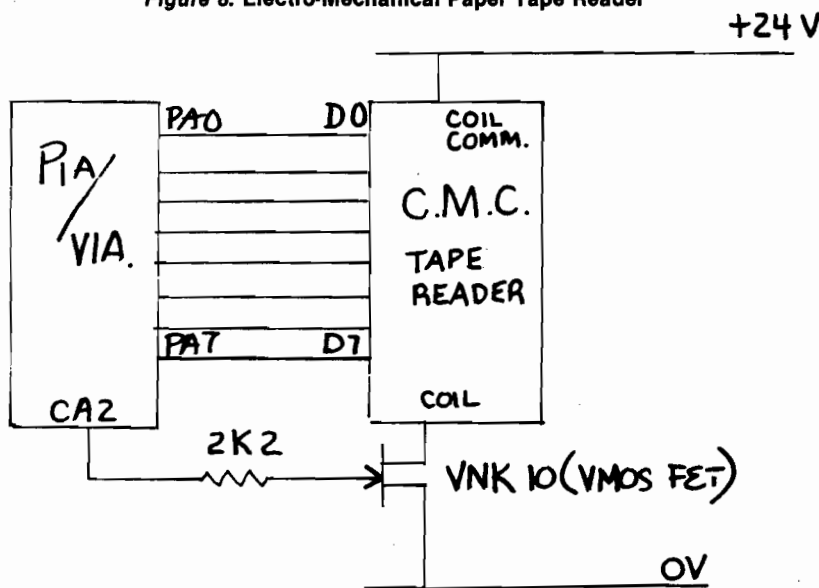

Charge MICRO and MICRO Books!

MICRO now accepts VISA and Mastercard. Credit card holders around the world can now order subscriptions and books by phone or mail.

Call (617) 256-5515 between 9:00 A.M. and 5:00 P.M. and say "Charge it!"

Or mail your order with your credit card name, number, and expiration date to

Order Department
MICRO
34 Chelmsford Street
P.O. Box 6502
Chelmsford, MA
01824

International Orders

If you are outside the U.S., you may pay by

1. VISA or Mastercard
or
2. International Money Order

We no longer accept bank drafts from foreign banks — even if the funds are drawn on an account in a U.S. bank! The rising bank charges now make payment by this method prohibitive.

**Make Your
Reference Library
Complete With
The Best of MICRO**

Volume 1—Contains 46 articles from October/November 1977 through August/September 1978: Apple articles (16), AIM 65 (1), KIM-1 (10), PET (9), OSI (1), SYM-1 (1), and General (8). 176 pages plus 5 tear-out reference cards (Apple, KIM, PET, and 6502), 8½ × 11 inches, paperbound. \$6.00

Volume 2—Contains 55 articles from October/November 1978 through May 1979: Apple articles (18), AIM 65 (3), KIM-1 (6), PET (12), OSI (3), SYM-1 (4), and General (9). 224 pages, 8½ × 11 inches, paperbound. \$8.00

Volume 3—Contains 88 articles from June 1979 through May 1980: Apple articles (24), AIM 65 (7), KIM-1 (9), PET (15), OSI (14), SYM-1 (11), and General (8). 320 pages, 8½ × 11 inches, paperbound. \$10.00

Ask for **The Best of MICRO** at your computer store. Or, to order with VISA or Mastercard

**Call TOLL-FREE
800-227-1617**

Extension 564

**In California 800-772-3545
Extension 564**

On orders received by August 31, 1981, we pay all surface shipping charges.

MICRO
34 Chelmsford Street
P.O. Box 6502
Chelmsford, MA 01824

Massachusetts residents add 5% sales tax.

Listing 3

```

;* JOYSTICK ROUTINE
;*
;* BY JACK MCDONALD
;*
;6532 ADDRESSED AT $E400
;
;          ORG $E480
;
E480 A980          LDA #$80
E482 8D03E4       STA $E403          ;PB7 IS OUTPUT
E485 8D02E4       STA $E402          ;PB7 SET HIGH
E488 AD05E4       LDA $E405          ;CLR INT FLAG
E48B 8D06E4       STA $E406          ;ENABLE PAY IRG (DATA =
;                                "DON'T CARE")
E48E A90F          LDA #$0F          ;16 MICROSEC
E490 8D1EE4       STA $E41E          ;TIMES 64
E493 A900          LDA #$00
E495 8D02E4       STA $E402          ;RESET 555 TIMER
E498 AD05E4       LDA $E405          ;IRQ YET?
E49B 2940         AND #$40          ;NO
E49D F0F9         BEQ WAIT          ;YES, READ TIME VALUE
E49F AD04E4       LDA $E404          ;RETURN TO MAIN PROG.
E4A2 40           RTI              WITH TIME VALUE IN ACC

```

Listing 4

```

;* PAPER TAPE READER
;*
;* BY JACK MCDONALD
;*
PIA      EQU $EA00
BUFF     EQU $03FF
;
;          ORG $300
;
0300 A000          LDY #$00
0302 201803       READ JSR STEP
0305 AD00EA       LDA PIA
0308 C9FF         CMP #$FF          ;START BYTE?
030A D0F6         BNE READ          ;NO
030C 99FF03       LOOP STA BUFF,Y        ;YES...START READING
030F 201803       JSR STEP
0312 AD00EA       LDA PIA
0315 C8           INY
0316 D0F4         BNE LOOP
0318              ;EXIT HERE, AS 256 BYTES HAVE BEEN READ
0318 A90E         STEP LDA #$0E
031A 8D0CEA       STA PIA+$0C        ;TURN CA2 ON
031D A920         LDA #$20
031F 8DFD03       STA $03FD        ;DELAY HIGH BYTE
0322 A9FF         DELAY LDA #$FF
0324 8DFC03       STA $03FC        ;DELAY LOW BYTE
0327 CEF003       DEC $03FC
032A D0F6         BNE DELAY
032C CEF003       DEC $03FD
032F D0F1         BNE DELAY
0331 A90C         LDA #$0C
0333 8D0CEA       STA PIA+$0C        ;TURN CA2 OFF
0336 60           RTS

```

SOFTWARE FOR OHIO SCIENTIFIC

VIDEO EDITOR

Video Editor is a powerful full screen editor for disk-based OSI systems with the polled keyboard (except CIP). Allows full cursor-control with insertion, deletion and duplication of source for BASIC or OSI's Assembler/Editor. Unlike versions written in BASIC, this machine-code editor is co-resident with BASIC (or the Assembler), autoloading into the highest three pages of RAM upon boot. Video Editor also provides single-keystroke control of sound, screen format, color and background color. Eight-inch or mini disk: \$14.95. Specify amount of RAM.

SOFT FRONT PANEL

Soft Front Panel is a software single-stepper, slow-stepper and debugger-emulator that permits easy development of 6502 machine code. SFP is a fantastic monitor, simultaneously displaying all registers, flags, the stack and more. Address traps, opcode traps, traps on memory content and on port and stack activity are all supported. This is for disk systems with polled keyboard and color (btw monitor ok). Uses sound and color capabilities of OSI C2/C4/CB systems (not for CIP). Eight-inch or mini disk \$24.95. Specify amount of RAM. Manual only, \$4.95 (May be later credited toward software purchase). Six page brochure available free upon request.

TERMINAL CONTROL PROGRAM

OSI-TCP is a sophisticated Terminal Control Program for editing OS-6503 files, and for uploading and downloading these files to other computers through the CPU board's serial port on OSI C2, C4 and CB disk-based systems with polled keyboards. Thirteen editor commands allow full editing of files, including commands for sending any text out the terminal port and saving whatever text comes back. INDUTL utility included for converting between BASIC source and TCP file text. Eight-inch or mini disk \$39.95. Manual only, \$2.95.

OSI-FORTH 2.0 / FIG-FORTH 1.1

OSI-FORTH 2.0 is a full implementation of the FORTH Interest Group FORTH, for disk-based OSI systems (C1,C2,C3,C4,CB). Running under OS6503, it includes a resident text editor and 6502 assembler. Over one hundred pages of documentation and a handy reference card are provided. Requires 24K (20K CIP). Eight-inch or mini disk \$79.95. Manual only, \$9.95. "OSI-FORTH Letters" software support newsletter \$4.00/year.

All prices postpaid. Florida residents add 4% tax. Dealer inquiries are invited. Allow 30 days for delivery.

WRITE FOR FREE CATALOG OF SOFTWARE AND HARDWARE FOR OHIO SCIENTIFIC !!

Technical Products Company
P.O. Box 12983 Univ. Station
Gainesville, Florida 32604

Flat Rate

DISK DRIVE OVERHAUL

One Week Turnaround Typical

Complete Service on Floppy Disk Drives.

FLAT RATES

8" Double Sided Drive	\$170.00*
8" Single Sided Drive	\$150.00*
5 1/4" M.P.I. Drive	\$100.00*

**Broken, Bent, or Damaged Parts Extra*

You'll Be Notified of

1. The date we received your drive.
2. Any delays and approximate time of completion.
3. Date Drive was shipped from our plant.
4. Repairs performed on your Drive.
5. Parts used (* and description).
6. Any helpful hints for more reliable performance.

90 Day Warranty.
Ship Your Drive Today.

Write or call for further details.

PHONE (417) 485-2501

FESSENDEN COMPUTER SERVICE
116 N. 3RD STREET OZARK, MO 65721

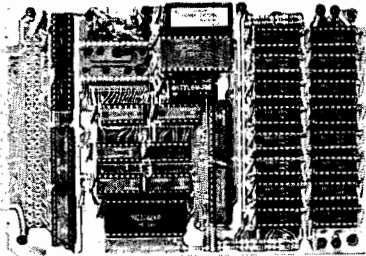

BETA 32K BYTE EXPANDABLE RAM FOR 6502 AND 6800 SYSTEMS AIM 65 KIM SYM PET S44-BUS

- Plug compatible with the AIM-65/SYM expansion connector by using a right angle connector (supplied).
 - Memory board edge connector plugs into the 6800 S44 bus.
 - Connects to PET using an adaptor cable.
 - Uses +5V only, supplied from the host computer.
 - Full documentation. Assembled and tested boards are guaranteed for one full year. Purchase price is fully refundable if board is returned undamaged within 14 days.
- Assembled with 32K RAM.....\$349.00
& Tested with 16K RAM..... 329.00
Bare board, manual & hard-to-get parts... 99.00
PET interface kit. Connects the 32K RAM board to a 4K or 8K PET.....\$ 69.00

See our full page ad in BYTE and INTERFACE AGE.

wabash

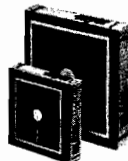

8" or 5 1/4" flexible diskettes certified 100% error free with manufacturers 5 year limited warranty on all 8" media. Soft sector in tilt-back* boxes of 10. 5 1/4" available in 10 Sector. (Add \$3.00 for plastic library cases)

8" single sided, single density.....	\$29.95
8" single sided, double density.....	37.95
8" double sided, double density.....	48.95
5 1/4" single sided, single density.....	27.95
5 1/4" single sided, double density.....	29.95

*Tilt-Back is a trademark of Wabash, Inc.

8" DISK DRIVES

Shugart 801R.....	\$390.00
NEC FD1160 (double sided).....	595.00
Memorex MRX-101 8" Winchester style, hard disk drive, 10 megabytes.....	\$2,000.00

TERMS: Minimum order \$15.00. Minimum shipping and handling \$3.00. Calif. residents add 6% sales tax. Cash, checks, Mastercard, Visa and purchase orders from qualified firms and institutions are accepted. Product availability and pricing are subject to change without notice.

INTERNATIONAL ORDERS: Add 15% to purchase price for all orders. Minimum shipping charge is \$20.00. Orders with insufficient funds will be delayed. Excess funds will be returned with your order. All prices are U.S. only.

16K MEMORY EXPANSION KIT \$29.00

For Apple, TRS-80 keyboard, Exidy, and all other systems using 4116 dynamic rams or equivalent. All IC's are prime Mitsubishi MK 4116-3.

- 200 NSEC access, 375 NSEC cycle
- Burned-in and fully tested
- 1 full year parts replacement guarantee

ROCKWELL AIM 65



AIM 65 with 1K ram.....	\$425.00
AIM 65 with 4K ram.....	485.00
AIM power supply.....	125.00
Professional AIM enclosure.....	169.00
Budget AIM enclosure.....	50.00
KIM enclosure.....	40.00
SYM enclosure.....	30.00

BETA
COMPUTER DEVICES
1230 W. COLLINS AVE.
ORANGE, CA 92668
(714) 633-7280



Name: SEGS
System: OSI
Language: OS65D
Hardware: Disk
Description: Adds segmentation commands to BASIC. Allows segment calls (like GOSUB's) to subroutines stored on disk. By nesting calls, large programs may be written and will run in memory. Write for more information.
Price: \$25.00
Available: Universal Systems
2020 W. County Rd. B
Minneapolis, MN 55113

Name: Fast Facts
System: Apple II & Apple II Plus
Memory: 48K
Language: Applesoft
Hardware: Disk 3.2 or 3.3, line printer desirable

Description: This selection of programs was created and designed by a Certified Financial Planner for quick analysis of the personal investment planning needs of his clients. It was professionally programmed for efficient and accurate operation. Fast Facts operates very easily with single key program selection and printing commands. In many cases the entire planning sequence is completed in less than 60 seconds. Specific program objects are divided into six systematic program fields. They are: 1) planning for retirement, 2) college financing for the kids, 3) diversifying your investments, 4) the result of inflation in devaluing your earnings, 5) costs of borrowing money and loan balance at any point in time, 6) investment calculations for compounding and future values. These programs were planned with care to allow you to change input data and in many cases identify erroneous entry values. Their primary value rests with their speed and ease of operation with no need to learn special control characters.
Copies: Version 1.1 just released
Price: \$95.00 includes disk and instructions

Author: Monte C. Fremouw
Available: Richard Lorange CFP
c/o Richard Lorange and Associates, Ltd.
3336 N. 32nd Street,
Suite 102
Phoenix, AZ 85018

Name: SYM-FORTH 1.0
System: SYM-1
Memory: 16K
Language: 8K machine language and FORTH
Hardware: Serial terminal and RAE ROMS

Description: SYM-FORTH 1.0 is a faithful implementation of the fig-FORTH model with the following additional features: unique input line editor; built-in 6502 FORTH assembler; dual cassette interface; FIG-style screen editor; upgrade to 79-STANDARD available through subscription to newsletter.

Copies: 50
Price: \$135 US/\$155 Canada - cassette version includes 74-page user guide, 100-page source listing, and object on cassette.
\$150 US/\$175 Canada - disk version for dual HDE mini disk system, as above but supplied on two mini floppies.
System boots with 79-Standard installed.

Author: John W. Brown
Available: Saturn Software Limited
8246 116A St.
Delta, BC., V4C 5Y9,
Canada

Name: Pegasus
System: UCSD Pascal operating systems
Memory: 48K and the Pascal Language Card
Language: UCSD Pascal
Hardware: Apple II, Language Card, CRT.

Description: This is a Data Base Management System. You can create, define, manipulate, print, list, write to disk, view and generally use data files. It is extremely user-oriented, especially for the novice user. It is menu driven.
Price: \$195.00 MSRP includes program diskette, technical manual, and 'cookbook.'

Author: Shakti Systems Inc.
Available: Powersoft, Inc.
POB 157
Pitman, NJ 08071

Name: 6502 C Cross-compiler
System: UNIX/V7, UNIX/V6 or Idris, RT-11, RSTS/E, RSX-11, VAX/VMS
Memory: 28K
Language: C
Hardware: PDP-11 series, LSI-11 series, VAX series

Description: This product is a C cross-compiler running on any of the above-mentioned hardware/software systems. It generates symbolic assembly language for the 6502 microprocessor. The full C language, as described by Kernighan and Ritchie's *The C Programming Language*, is supported except for three minor features. This product complements the existing line of C compilers and cross-compilers from Whitesmiths, Ltd, of New York.
Price: \$1600 plus media charge (\$30 for floppies, \$50 for magtape) includes documentation and binary license for use on a single host CPU

Author: Staff
Available: Advanced Digital Products, Inc.
1701 Twenty-first Ave., S.
Nashville, TN 37212

Name: Home Energy Survey
System: OSI-4P and PET-2000
Memory: 24K (OSI), 8K/16K/32K (PET)
Language: BASIC
Hardware: Minifloppy (OSI) Cassette (PET)

Description: This program calculates the savings a home owner will achieve by adding storm windows, changing thermostat settings, caulking, weatherstripping, adding ceiling insulation, and adding floor insulation. The program is valid for the 48 contiguous states and for the following heating and cooling fuels: oil, natural gas, electricity, wood, propane (LPG), and coal. The user inputs city, state, fuel cost, window area, floor area, thermostat settings, ceiling and floor R values.
Price: \$15.95

Author: David E. Pitts
Available: David E. Pitts
16011 Stonehaven Dr.
Houston, TX 77059

Name: **C.O.R.P. (Combined Operations Re-entrant Programming Data-Base Management System)**

System: Apple II
Memory: 48K
Language: Applesoft BASIC
Hardware: 2 disk drives (DOS 3.3), Applesoft in ROM, video monitor, optional printer

Description: C.O.R.P. is a program generator that writes complete data-entry and print programs in Applesoft BASIC. These programs are written on a standard DOS 3.3 disk and may be modified by the user. The system includes a sort, update and copy facility along with the ability to modify important system functions. The generated programs utilize keyed random access for fast record retrieval. A complete diagnostic package is also included.

Price: \$189.95 includes master and diagnostic disks/manual

Author: Alexander Maromaty
Available: Maromaty & Scotto Software Corp.
P.O. Box 610
Floral Park, NY 11001

Name: **GRAFFAK, TIGR**
System: Apple II
Memory: 32K minimum
Language: BASIC and machine
Hardware: Disk II and Integral Data IDS 560 or 460

Description: Provides 1 or 2 x horizontal and 1 to 3 x vertical reproduction of either Hi-Res page, and 1 to 3 x vertical reproduction of both pages side by side. 3 x horizontal and 4 or 5 x vertical reproduction on IDS 560, only. Normal/inverse inking and indentation in inches are user-specified. Compatible with most I/O cards. Extremely simple to use. Versions available for other printers!

Price: \$39.95 for 460 version (plus 5.5% tax in Ohio)
\$49.95 for 560 version

Author: Robert Rennard
Available: SmartWare
2281 Cobble Stone Court
Dayton, Ohio 45431

Name: **Job Control System**
System: Apple II
Memory: 48K
Language: Pascal
Hardware: Three disk drives and a 132-column printer capable of performing a form feed.

Description: Computer-assisted job control for small-to-medium-size companies in manufacturing, construction and service industries. This system

provides management with reliable measures of productivity furnishing up-to-the-minute job status data for determining the real cost of producing a product or providing a service. Several valuable reports including job listing, job cost summaries, detailed individual job reports, and work-in-process reports give profit/loss values and variances so that job estimates and work standards can be fine-tuned.

Price: \$750.00
Author: Shop Controls Inc.
Available: High Technology Software Products Inc.
P.O. Box 14665
8001 N. Classen Blvd.
Oklahoma City, OK 73113

Name: **FBASIC Compiler**
System: All Ohio Scientific 8" Disk Systems (OS65D Operating System)
Memory: 48K
Language: FBASIC
Hardware: OSI 8" disk systems
Description: Super-fast BASIC compiler. Compiles an integer-subset of OSI/Microsoft BASIC into native 6502 machine code. Features user-definable array locations, WHILE loops, GOTOs and GOSUBs to absolute addresses,

direct access to 6502 registers, and much more. FBASIC is fully diskbased, and is capable of producing programs larger than available memory.

Price: \$155.00 ppd. includes 8" disk with compiler, many example programs, and user manual.
Author: Richard Foulk
Available: Pegasus Software
P.O. Box 10014
Honolulu, HI 96816

Name: **0-3. Option Strategy Charts**

System: PET
Memory: 8K
Language: BASIC
Hardware: PET/CBM
Description: Charts are plotted for two assumed situations of option strategies of puts and calls and their combinations. The plot of strategy values for a series of underlying stock prices permit comparison of the assumptions.
Price: \$15.00
Author: Claud E. Cleeton
Available: Claud E. Cleeton
122-109th Ave., S.E.
Bellevue, WA 98004

CBM/PET? SEE SKYLES ... CBM/PET?

PET? SEE SKYLES ... CBM/PET? SEE

"Look how fast I create these great graphic displays on my PET with the new PicChip... it's like home movies."

PicChip, the new ROM that took Europe by storm, available only from Skyles Electric Works in the U.S. and Canada.

PicChip, a ROM extension of the BASIC version III, BASIC 4.0 or BASIC 8032 interpreter that offers over 40 commands that allow you to create programs with dynamic graphics displays: plots, bar graphs, pictures; and rolling, scrolling, shifting and inverting. All instantly and easily added to your BASIC program.

The address for the 2000/3000 (which would require PicChip module PC2), for the 4000 (PC4), and for the 8000(PC8) is \$A000... unless you have a Mikro, WordPro III or IV, or Jinsam, which occupy that same address. In those cases, you will need the PicChip on an interface board that would reside in address B800... for the 2000/3000 series (PCB2), above the Toolkit. For the 4000 (PCA4) and 8000 (PCA8), the Mikro or WoodPro would be switchable manually using the Skyles Socket-2-ME.

Skyles guarantees your satisfaction: if you are not absolutely happy with your new PicChip return it to us within ten days for an immediate, full refund.

PicChip from Skyles Electric Works (Please indicate PC2, PC4, PC8).....\$60.00

Complete with interface board (Please indicate PCB2, PCA4, PCA8)..... 80.00

Shipping and Handling.....(USA/Canada) \$2.50 (Europe/Asia) \$10.00

California residents must add 6%/6½% sales tax, as required.



Skyles Electric Works
231E South Whisman Road
Mountain View, California 94041
(415) 965-1735

Visa/Mastercard orders: call tollfree (800) 227-9998 (except California). California orders: please call (415) 965-1735.

SEE SKYLES ... CBM/PET? SEE SKYLES

... CBM/PET? SEE SKYLES ... CBM/PET?

APPLESCOPE

DIGITAL STORAGE OSCILLOSCOPE
Interface for the Apple II Computer

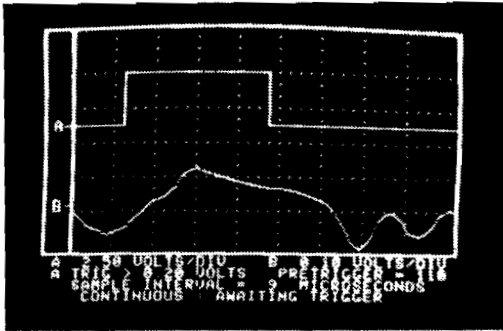

The APPLESCOPE system combines two high speed analog to digital converters and a digital control board with the high resolution graphics capabilities of the Apple II computer to create a digital storage oscilloscope. Signal trace parameters are entered through the keyboard to operational software provided in PROM on the DI control board.

- DC to 3.5 Mhz sample rate with 1024 byte buffer memory
- Pretrigger Viewing up to 1020 Samples
- Programmable Scale Select
- Continuous and Single Sweep Modes
- Single or Dual Channel Trace
- Greater than or less than trigger threshold detection

Price for the two board Applescope system is **\$595**

For further information contact: **RC ELECTRONICS INC.**
7265 Tuolumne Street
Goleta, CA 93117
(805) 968-6614

Dealer Inquiries Invited

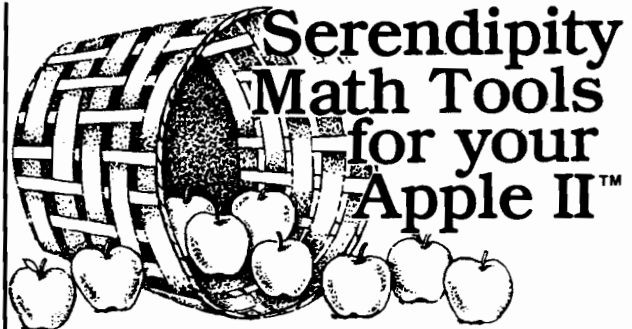

INTER-STAT™ offers you a full range of interactive statistical analysis techniques, from averages and medians to binomial and poisson distributions, correlation coefficients and one- and two-way analysis of variance. \$169.

ADVANCED MATH ROUTINES is the mathematical tool kit for common, yet complex numerical problems. Routines include: linear regression, matrix operations, numerical calculus, differential equations and data set recall for iterative calculations. \$169.

Thoroughly tested, well documented and easy to master, each package includes a 30+ page self-teaching manual.

Serendipity's complete line of software solutions for business, education and professional applications are available at your local Computerland or Apple dealer.

For a free brochure, or to order direct contact Serendipity Systems, 225 Elmira Road, Ithaca, NY 14850.
Phone 607-277-4889. Visa and MC accepted.

™Apple Computer

SERENDIPITY SYSTEMS



PET & APPLE II USERS

TINY PASCAL

Plus +
GRAPHICS



The TINY Pascal System turns your APPLE II micro into a 16-bit P-machine. You too can learn the language that is slated to become the successor to BASIC. TINY Pascal offers the following:

- **LINE EDITOR** to create, modify and maintain source
- **COMPILER** to produce P-code, the assembly language of the P-machine
- **INTERPRETER** to execute the compiled P-code (has TRACE)
- **Structured programmed constructs:** CASE-OF-ELSE, WHILE-DO, IF-THEN-ELSE, REPEAT-UNTIL, FOR-TO/DOWNTO-DO, BEGIN-END, MEM, CONST, VAR ARRAY

Our new TINY Pascal PLUS+ provides graphics and other builtin functions: GRAPHICS, PLOT, POINT, TEXT, INKEY, ABS AND SQR. The PET version supports double density plotting on 40 column screen giving 80 x 50 plot positions. The APPLE II version supports LORES and for ROM APPLESOFT owners the HIRES graphics plus other features with: COLOR, HGRAPHICS, HCOLOR, HPLOT, PDL and TONE. For those who do not require graphics capabilities, you may still order our original Tiny Pascal package.

TINY Pascal PLUS+ GRAPHICS VERSION-

PET 32K NEW Roms cassette.....	\$55
PET 32K NEW Roms diskette.....	\$50
APPLE II 32K/48K w/DOS 3.2 or 3.3.....	\$50

TINY Pascal NON-GRAPHICS VERSIONS-

PET 16K/32K NEW Roms cassette.....	\$40
PET 16K/32K NEW Roms diskette.....	\$35
APPLE II w/ROM Applesoft 32K w/DOS.....	\$35
APPLE II w/ROM Applesoft 48K w/DOS.....	\$35

USER's Manual (refundable with software order).....	\$10
6502 Assembly Listing of INTERPRETER-graphics.....	\$25
6502 Assembly Listing of INTERPRETER-non graphics.....	\$20



FREE postage in U.S. and CANADA. Orders may be prepaid of by bankcard (include card number and expiration dates. Michigan residents include 4% state sales tax. Orders accepted via THE SOURCE - CLO62.



ABACUS SOFTWARE
P.O. Box 7211
Grand Rapids, Michigan 49510
(616) 241-5510

Decision Systems

Decision Systems
P.O. Box 13006
Denton, TX 76203

SOFTWARE FOR THE APPLE II*

ISAM-DS is an integrated set of Applesoft routines that gives indexed file capabilities to your BASIC programs. Retrieve by key, partial key or sequentially. Space from deleted records is automatically reused. Capabilities and performance that match products costing twice as much.
\$50 Disk, Applesoft.

PBASIC-DS is a sophisticated preprocessor for structured BASIC. Use advanced logic constructs such as IF...ELSE..., CASE, SELECT, and many more. Develop programs for Integer or Applesoft. Enjoy the power of structured logic at a fraction of the cost of PASCAL.
\$35. Disk, Applesoft (48K, ROM or Language Card).

DSA-DS is a dis-assembler for 6502 code. Now you can easily dis-assemble any machine language program for the Apple and use the dis-assembled code directly as input to your assembler. Dis-assembles instructions and data. Produces code compatible with the S-C Assembler (version 4.0), Apple's Toolkit assembler and others.
\$25 Disk, Applesoft (32K, ROM or Language Card).

FORM-DS is a complete system for the definition of input and output forms. FORM-DS supplies the automatic checking of numeric input for acceptable range of values, automatic formatting of numeric output, and many more features.
\$25 Disk, Applesoft (32K, ROM or Language Card).

UTIL-DS is a set of routines for use with Applesoft to format numeric output, selectively clear variables (Applesoft's CLEAR gets everything), improve error handling, and interface machine language with Applesoft programs. Includes a special load routine for placing machine language routines underneath Applesoft programs.
\$25 Disk, Applesoft.

SPEED-DS is a routine to modify the statement linkage in an Applesoft program to speed its execution. Improvements of 5-20% are common. As a bonus, SPEED-DS includes machine language routines to speed string handling and reduce the need for garbage clean-up. Author: Lee Meador.
\$15 Disk, Applesoft (32K, ROM or Language Card).

(Add-\$4.00 for Foreign Mail).

*Apple II is a registered trademark of the Apple Computer Co.

6502 Bibliography: Part XXXV

1025. MICRO No. 32 (January, 1981)

- Davis, Robert V., "Print Using," pg. 6.
Print Using for the OSI C1P.
- Finkbeiner, Tim, "List Disable," pg. 6.
List disable for OSI ROM BASIC.
- Young, George, "Keyboard Encoding," pg. 7-14.
Add a keypad or keyboard to your 6502 micro.
- Childress, J.D., "A Better Apple Search/Change,"
pg. 17-19.
An improved version of the Search/Change program for
the Apple.
- Bassman, Mike, "Vectors and the Challenger 1P," pg. 21.
A tutorial on Vectors and how to use them on the OSI
C1P.
- Kolbe, Werner, "PET Symbolic Disassembler,"
pg. 23-26.
This disassembler generates labels and symbols for the
critical addresses.
- Flynn, Christopher J., "AIM 65 File Operations,"
pg. 29-32.
The third part of a series on AIM 65 file processing.
- Tenny, Ralph, "Full Disassembly Listing on Small
Systems," pg. 37-39.
A utility for the KIM or other small system.
- Green, Len "Bridge Trainer," pg. 41-46.
A program for the SYM-1.
- Wright, Loren, "PET Vet," pg. 51.
Notes on the update for VIC, finding BASIC variables,
etc.
- Neiburger, E.J., "Make a Clear Plastic Cover for Your
Apple," pg. 53.
A constructional, how-to article related to the Apple.
- Little, Gary B., "Searching String Arrays," pg. 57-59.
An Apple matching language program to rapidly search
a large string array.
- DeJong, Marvin L., "Interfacing the 6522 Versatile Inter-
face Adapter," pg. 65-72.
How to implement the 6522 on your 6502 system.
- Cain, Les, "Fun With OSI," pg. 75-76.
A checker game using C1P graphics.
- Anon., "Ohio Scientific's Small Systems Journal,"
pg. 82-86.
Memory Tests, Bit Rotation Test, Pseudo-Random
Test, etc.
- Staff, "MICRO Software Catalog: XXVIII," pg. 87.
Fourteen software items for 6502 micros.
- Dial, Wm. R., "6502 Bibliography: Part XXVIII,"
pg. 90-94.
Over 150 additional references to the extensive 6502
literature.

1026. Apple Bits 3, No. 1 (January, 1981)

- Kovalik, Dan, "Taking the Mystery and Magic Out of
Machine Language," pg. 3-4.
This month's tutorial on machine language includes a
routine called Directory Compress, eliminating the
holes left in the directory by deleted files.

1027. Compute! 3, No. 1, Issue 8 (January, 1981)

- Butterfield, Jim, "Financial Fuzzies," pg. 22.
A numbers formatting routine for the PET.
- Deemer, B.J., "Spend Time, Save Money!," pg. 22-23.
Hints on using the PET cassette.
- Semancik, Susan, "Micros with the Handicapped,"
pg. 26-27.
Discussion of techniques for the handicapped (PET).
- Albrecht, Bob and Firedrake, George, "The Mysterious
and Unpredictable RND: Part 1."
A tutorial on the PET use of the RND function.
- Pratto, R., "Cursor Classifications Revisited," pg. 38.
A system of classification for PET programs.
- Butterfield, Jim, "Odds and Ends Re PET Cassette Tape."
A collection of PET cassette-related hints and notes.
- Falkner, Keith, "Load PET Program Tapes into the Apple
II," pg. 50-59.
A "PET Loader" for the Apple.
- DeJong, Marvin L., "Programming and Interfacing the
Apple, with Experiments," pg. 61-65.
A hardware and experimental article related to the Apple.
- Crawford, Chris, "Player-Missile Graphics with the Atari
Personal Computer System," pg. 66-71.
An Atari graphics tutorial.
- Baker, Al, "The Fluid Brush," pg. 72-73.
A joystick-graphics program for the Atari.
- Lindsay, Len, "Atari Disk Menu," pg. 74-77.
An Atari tutorial on disk menus.
- Bruun, James L., "Using the Atari Console Switches,"
pg. 77.
Some hints on using those switches by the Atari
keyboard.
- Beseke, Roger, "The Atari Disk Operating System,"
pg. 78-79.
A quick and brief description of what you can do with
Atari DOS.
- White, Jerry, "Atari Sounds Tutorial," pg. 79-80.
Discover some of the sounds of your Atari.
- Gordon, Thomas G., "A 6502 Disassembler," pg. 81-82.
A disassembler for the OSI micros.
- Berger, T.R., "A Small Operating System: OS65D — The
Kernel: Part 1," pg. 84-91.
A tutorial on the OS65D system for OSI micros.
- Stanford, Charles L., "OSI C1P Fast Screen Clears
Revisited," pg. 91.
Techniques for screen clearing on OSI micros.
- Mansfield, Richard, "The Screen Squeeze Fix for CBM
8000," pg. 92-93.
How to adapt programs to the new CBM 80-column
screen micros.
- Herman, Harvey B., "Hooray for SYS," pg. 96-100.
A tutorial for the SYS command for PETs, with three
listings.
- Butterfield, Jim, "Scanning the Stack," pg. 102-106.
An instructional article on PET's machine language.

Isaacson, Dan, "Detecting Loading Problems and Correcting Alignment On Your PET," pg. 114-115.

Hints on improving the reliability of the PET cassette loading procedure.

Peterson, T.M., "Spooling for PET with 2040 Disk Drive," pg. 118.

Save to disk now, print later.

Levinson, V.M.D., "Variable Dump for New ROM PETs," pg. 118-120.

A routine to list all defined PET BASIC program variables and give current values.

Wuchter, Earl H., "The 32K Bug," pg. 120.

A special procedure for 32K PETs to avoid screen boundary problems.

Hudson, Arthur C., "An 'Ideal' Machine Language Save for the PET," pg. 121-122.

A procedure for the PET.

Huckell, Gary R., "PET/CBM IEEE Bus Error," pg. 124-125.

An error in the PET IEEE I/O routine and a fix.

Rehnke, Eric, "The Single Board 6502: High-Speed Data Transfer," pg. 126-130.

Software which dumps object code from either the AIM, SYM, or 6522-equipped Apple to a KIM board.

Hooper, Philip K., "Caveat Interrupter or Placating a Rebellious KIM without Sacrificing RAM," pg. 132.

An experiment with a runaway KIM.

Chamberlin, Hal, "Expanding KIM-Style 6502 Single Board Computers," pg. 138-142.

Part 1 of a series on expanding small micros.

1028. Call -Apple 4, No. 1 (January, 1981)

Goez, Eric E., "Real Variable Study," pg. 8-23.

About numbers, scientific notation, several listings, etc. for the Apple.

Reynolds, Lee, "Applesoft Sub-String Search Function," pg. 26-30.

A utility for Apple users, called Ampersand-Instr. Function.

Zant, Robert F., "Data Storage Techniques," pg. 35-38.

An article to assist the understanding of files.

Anon., "How to Enter Call -Apple Assembly Language Listings," pg. 39.

A short instructional article for the Apple assembly language.

Wiggington, Randy, "Fast Garbage Collection," pg. 40-45.

Speed up your Apple with this utility.

Ender, Philip B., "Pascal Zap," pg. 47-49.

A utility allowing access to any block on the disk, including the directory and deleted files.

Lingwood, David A., "Adding Lines to Running Applesoft," pg. 51-53.

This assembler program can be instructed to replace any REM statement with program code in a running BASIC Applesoft program.

Anon., "Write -Apple," pg. 55.

Some notes on the fix for the use of Applewriter with the Paymar Lower Case chip; also a fix for a bug on the DOS 3.3 master disk.

Horsfall, Richard C., "Bsaving and Bloading Arrays in Integer BASIC and Applesoft," pg. 58-61.

Two utility listings for the Apple.

1029. Peek(65) 2, No. 1 (January, 1981)

McGuire, Dick, "Tech Notes," pg. 2-5.

Fix for packer; user defined input; cassette corner; US error; right justification, etc.

Wallis, Terry L., "OS65U Port #5 to Port #8 Modification," pg. 10.

An assembly source listing to modify OS65U so that a Port #5 command sends output to Port #8.

Grittner, Kurt, "Print Enhancements of 65D V3.0," pg. 15-18.

A formatting program for numbers and dollars/cents on OSI systems.

1030. Apple Gram 3, No. 1 (January, 1981)

Matzinger, Bob, "Binary Manipulation," pg. 4-7.

How the computer handles numbers.

Meador, Lee, "MON I/NOMON I Flag," pg. 8.

A discussion of the MON function.

Carpenter, Chuck, "Apple Blossoms — For Newcomers," pg. 16-17.

A short introduction to assembly and machine languages.

Hatcher, Rich, "Hello Program Improvement," pg. 20-21.

A Hello program for the Apple disk.

1031. Appleseed 2, No. 5 (January, 1981)

Pump, Mark, "Apple II DOS Internals," pg. 4-6.

DOS memory/disk addresses cross reference for the Apple.

1032. Apple Assembly Line 1, Issue 4 (January, 1981)

Sander-Cederlof, Bob, "A Calculated GOSUB for Applesoft," pg. 8.

Restore this useful function to Applesoft.

Sander-Cederlof, Bob, "How to Move Memory in the Assembler," pg. 2-6.

A tutorial on moving data with the S-C Assembler, with two machine language listings.

Meador, Lee, "Putting COPY in S-C Assembler II," pg. 9.

How to install this function.

Laumer, Mike, "EDIT Command for S-C Assembler II," pg. 10-11.

Discussion and listing for a new feature for the Assembler.

1033. Creative Computing 7, No. 1 (January, 1981)

Fee, Peter, "No PET Peeves," pg. 24-25.

The VIC-20 is a new Commodore computer based on the 6502 and selling under \$300.

Nasman, Leonard, "Atari Music Composer Cartridge," pg. 26.

A music system for the Atari.

Kruse, Richard M., "An Atari Library of Sound," pg. 74-78.

A series of listings for Atari sound routines from which you can select for adding that ringing telephone, etc. to your program.

Miller, David, "Apple-Sketch," pg. 110-118.

Aff instructional article on Hi-Res graphics, including a program for the Apple to make things easier.

Lubar, David, "Apple II Lo-Res Shape Tables," pg. 120-124.

Simplify moving Lo-Res figures around by using shape tables as is common with the Apple Hi-Res graphics.

Hitchcock, Paul, "Hi-Res Text for the Apple," pg. 126-129.

Embellish that Hi-Res Apple display with text. Label the axes of graphs, etc.

Bobhop, Bish, "Lit'l Red Bug," pg. 130-131.

A car-driving game for the Apple.

Tunbo, David, "The Digital Couch," pg. 132-133.

Turn your Apple into a psychiatrist.

Piele, Donald T., "How to Solve It — With the Computer," pg. 142-151.

Part Four on probability with a number of problems and Apple solutions.

Yob, Gregory, "Personal Electronic Transactions," pg. 156-163.

A printer list program, discussion of 6502 machine language (Monjana/1) and the big keyboard. Also a Hangmath for PET.

Carpenter, Chuck, "Apple-Cart," pg. 170-175.

Discussion of DOS 3.3. An Applesoft BUG in the GET/Val function.

Blank, George, "Outpost: Atari," pg. 176-179.

Discussion of bytes, nibbles and bits in digital counting. Notes on Atari graphics, etc.

1034. Abacus II 3, Issue 1 (January, 1981)

Davis, James P., "Printer On Says-A-Me (Expanded)," pg. 3-4.

Many new features added in this new listing of the Apple/Trencom 200/All-g printer program.

Morris, Gary, "Apple II Disk Soft Sectoring," pg. 5-6.

Discussion of diskette nibblizing and self sync.

Davis, James P., "Update Your DOS 3.3," pg. 7-8.

An update for a DOS 3.3 bug and some further improvements, especially for those running language cards or turnkey systems.

Smith, Paul D., "Convert Feet, and 1/16ths to Decimal Feet and Back Again," pg. 9.

A subroutine for the Apple useful to architects, engineers, contractors, etc.

Morris, Gary, "Format of Directory Information for Apple Pascal," pg. 10-12.

An instructional article for Pascal users.

Robbins, Greg, "Blood Finder," pg. 13.

A program to print the starting address and length in hex of a binary program immediately after it is Blooded.

Anon., "IAC Apnote: Tabbing with Apple Peripherals," pg. 14-16.

A utility for the Apple.

1035. Personal Computing 5, No. 1 (January, 1981)

Jong, Steven, "Word Processing Software Roundup," pg. 26-33.

A review of a number of word processors including several for 6502 systems.

Pritchett, Robert A., "A Pseudo-Numeric Key Pad for the Apple II," pg. 46-47.

An inexpensive substitute for a separate numeric keypad.

Swan, Tom, "Understanding BASIC Language Operations," pg. 68-72.

An introduction to Applesoft, including two utility routines, which remove REM statements from Integer or Applesoft listings.

1036. The Harvest 2, No. 6 (February, 1981)

Anon., "More Pascal," pg. 6-8.

Program Lookit is a primer that will display the Pascal character set on your Apple Hi-Res screen.

1037. Apple/Sass 3, No. 1 (February, 1981)

Burger, Mike, "Text POKE Locator," pg. 8-9.

An Apple program to find the POKE locations on the Text Screen.

McDowell, Bob, "Integer REM Formatter."

A short utility to assist in formatting REM statements on the Apple.

McDowell, Bob, "Secret," pg. 12.

A routine to provide copy protection on a tape program.

Lew, Art, "READ,, DATA and Selective RESTORE," pg. 21.

A short utility routine for the Apple.

Lew, Art, "Musical Notes," pg. 23.

A simple sound routine for the Apple.

1038. Peelings II 2, No. 1 (January/February, 1981)

Staff, "Apple Programs Software Reviews."

Over 20 programs for the Apple are reviewed in some detail. Included are utilities, sound routines, personal programs, data base management, games and miscellaneous discussions.

1039. Recreational Computing 9, No. 4, Issue 49 (January/February, 1981)

Walker, Robert J., "PET Budget Program," pg. 14.

This program for the PET totals expenses on a daily basis in six categories for the week.

Lopez, Antonio, Jr., "The Key to the Education Revolution," pg. 18-21.

A series of educational math programs, some for the Apple or adaptable to 6502 systems.

1040. Apple-Com-Post Issue 7 (ca. February, 1980)

Goetzke, Uwe, "Neue PASCAL-(Er)kenntnisse," pg. 16-17.

Notes for Pascal users, including a routine for PEEK and POKE, Integer input, etc.

Goetzke, Uwe, "Pascal-eine Einfuehrung," pg. 16.

An introduction to Apple Pascal.

Barbieri, Nino, "Program Kneipe," pg. 20.

A graphics program for the Apple.

6809 SYSTEMS ☺ 6809 SYSTEMS ☺ 6809 SYSTEMS ☺ 6809 SYSTEMS

Featuring the GIMIX mainframe with 30 amp C.V. ferro-resonant power supply; fifteen 50 pin and eight 30 pin slot Mother Board; 2 Mhz CPU with time of day clock & battery back-up. 1K RAM, 6840 programmable timer, provisions for 9511A or 9512 Arithmetic processors, and 4 PROM/ROM/RAM sockets that can hold up to 32KB of monitor or user software.

VARIETY: you can have 32KB, 56KB, 128KB and up of static RAM. You can use 5" and/or 8" disk drives, single or double density, single or double sided, and single or double tracking with GIMIX disk controllers. You have a wide choice of serial or parallel I/O cards.

EXPANDABILITY: You can add memory, I/Os, Video or Graphics cards, Arithmetic processors, additional drive capacity, and other hardware now or in the future to this SS50 bus structured system from GIMIX or other SS50 bus compatible manufacturers.

SOFTWARE VERSATILITY: GIMIX systems can use TSC's FLEX or UNIFLEX and MICROWARE'S OS-9 operating systems. A wide variety of software and languages is available for these systems.

QUALITY: All boards are assembled, burned-in, and tested and feature GOLD PLATED BUS CONNECTORS. Only top quality components are used and all boards are fully buffered for maximum system expansion. All boards come complete with bus connectors and all necessary instruction and documentation.

GIMIX designs, manufactures and tests, in-house, their complete line of products. Complete systems are available to fit your needs. Please contact the factory if you have any special requirements.

For further information, pricing and brochures, contact:



GIMIX inc.

The Company that delivers Quality Electronic products since 1975.

1337 WEST 37th PLACE, CHICAGO, IL 60609
(312) 927-5510 • TWX 910-221-4055

GIMIX* and GHOST* are registered trademarks of GIMIX inc.

Flex and Uniflex are trademarks of Technical Systems Consultants inc. OS9 is a trademark of Microware inc. See their ads for other GIMIX compatible software.

1041. Apple-Com-Post Issue 8 (ca. April, 1980)

Schultz, Heinz Juergen, "Verriegelung der RESET — Taste beim Apple II," pg. 8.

Hardware mod to disable the Reset key on the Apple.

Schultz, Heinz Juergen, "Bauanleitung eines Microfon-Verstaerkers fur Apple II-Kassetteneingang," pg. 9.

A hardware addition for the Apple to amplify the cassette input.

1042. Apple-Com-Post Issue 10 (ca. August, 1980)

Reske, B., "HGR-Besonderheiten des ITT 2020," pg. 10.

Notes on Hi-Res graphics for the Apple.

Vermeir, Jochen, "Unterbrechung des Laufenden Programms mit einer Nachricht," pg. 1214.

An interrupt routine using an Apple clock.

Zimmermann, W., "Der Apple II Liest PET-Programme," pg. 15-17.

An Apple program to read PET tapes.

1043. Apple-Com-Post Issue 11 (ca. October, 1980)

Dederichs, W., "Umschalter fuer die Verschiedenen Darstellungsformen des Apple II," pg. 4-8.

A tutorial for the Apple.

Dietrich, M., "Einfuehrung in Assembler," pg. 9-12.

Knuelle, A., "Quicksort," pg. 15-16.

Reske, Bruno, "Pascal Echounterdruckung u. — Druckfiles," pg. 17-18.

A Pascal printing program for the Apple.

1044. Apple-Com-Post Issue 12 (ca. December, 1980)

Schultz, H.J., "Umbauanleitung Apple II auf Grosz/Kleinschreibung," pg. 5-6.

An upper case/lower case modification for the Apple.

Dederichs, W., "Analyse des Befehls H PLOT ...TO...," pg. 7-8.

All about the H PLOT command in Apple Hi-Res graphics.

Dederichs, W., "Pascal-Text-Files Lesen," pg. 12-15.

An Applesoft program to read Pascal text files.

WE'VE GOT YOU COVERED

Attractive Functional Packaging for the KIM-1, SYM-1 and AIM-65

- VITAL COMPONENTS PROTECTED
- ALL FASTENERS PROVIDED
- EASILY ASSEMBLED

DESIGNED AND ENGINEERED SPECIFICALLY FOR YOUR MICROCOMPUTER:

- High Quality Thermoformed Plastic*
- Molded In Color
- Available From Stock

*Rohm & Hass - KYDEX 100

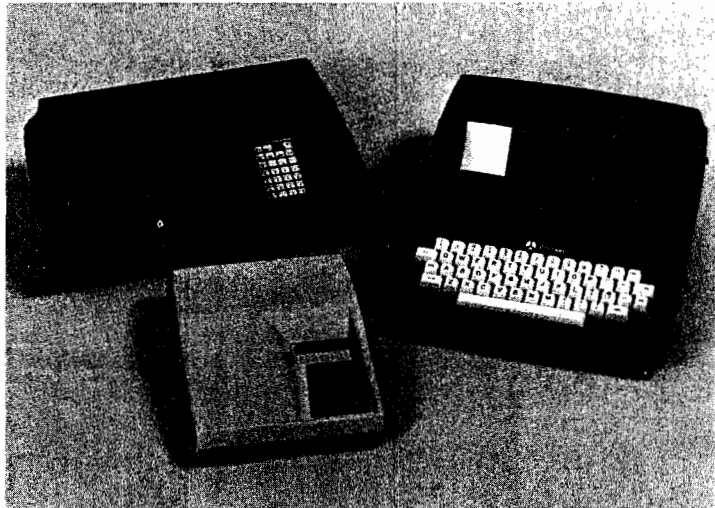

SSE 1-1 for SYM-1 SAE 1-1 for AIM-65
SKE 1-1 for KIM-1

enclosures group

786 bush street
san francisco, california 94108

TO ORDER: 1. Fill in this coupon (Print or Type Please).
2. Attach Check or Money Order.

___ SSE 1-1(s) (Blue) @ \$39.50 each ___ SAE 1-1(s) (Grey/Black) @ \$46.50 each
 ___ SKE 1-1(s) (Beige) @ \$29.50 each ___ SAE 1-2(s) (Deep Base) @ \$49.50 each

California Residents Please Add 6½% State Sales Tax To Total.

TOTAL ENCLOSED: \$ _____

MAIL TO: NAME _____

STREET _____ CITY _____ STATE _____ ZIP _____

Dealer Inquires Invited. — No C.O.D.'s Please. — Allow 2-3 Weeks for Processing and Delivery.

SOFTWARE FOR OSI

VIDEO GAMES 3 **NEW!** **\$14.95**

Three games. Meteor Mission is an asteroids game. Space Wars is a battle between two starships. Meteor Wars is a combination of the two above games. All three are in machine language with fast, real time action, and super graphics.

ADVENTURE: IMMORTALITY **NEW!** **\$11.95**

You are an intrepid explorer searching for the fabled "Dust of Immortality". This is the largest adventure yet available for 8K OSI! With hidden room load so you can't cheat.

SUPER BUG! **\$6.95**

Here's a super-fast, BASIC/Machine language hybrid race game. Ten levels of difficulty and an infinitely changing track will keep you challenged.

STARGATE MERCHANT **\$9.95**

You are a trader in the distant future, traveling through 'stargates' to get to various star systems. Part video game, part board game, always challenging.

ADVENTURE: MAROONED IN SPACE **\$11.95**

An adventure that runs in 8K! Save your ship and yourself from destruction.

DUNGEON CHASE **\$9.95**

A real-time video game where you explore a twenty level dungeon.

DISASSEMBLER **\$11.95**

Use this to look at the ROMs in your machine to see what makes BASIC tick. Reconstruct the assembler source code of machine language programs to understand how they work. Our disassembler outputs unique suffixes which identify the addressing mode being used, no other program has this!

SUPER! BIORHYTHMS **\$14.95**

A sophisticated biorhythm program with many unique features.

For all BASIC-in-ROM systems. Selected programs available on disk. Color and sound on video games.

Write for **FREE** catalog
(For International requests, please supply 2 oz. postage)

ORION SOFTWARE ASSO.
147 Main St. Ossining, NY 10562

ROCKWELL AIM USERS:

This ad will only run once!

Due to a cancelled project, the following hardware was never used and must be converted to liquid cash:

- 2 RMS 122 64,000 byte single board
Bubble systems
- 2 RMS 121 32,000 byte single board
Bubble systems
- 4 E02119 Expansion boards
- 2 Ram boards
- 2 16K Ram boards with memory
- 2 Experimenter boards
- 2 Aim 65 computers

MAIL SEALED BIDS TO:

D & F Enterprises
7000 Carroll Avenue
Takoma Park, MD 20012

Highest bidder will be notified.
Equipment will be shipped upon receipt of a certified check.

Bids will be opened August 31, 1981.

MICRO

Advertisers' Index

Advertiser's Name	Page
Aardvark Technical Services.....	6
Abacus Software.....	106, 112
Andromeda, Inc.....	1
Applied Analytics, Inc.....	39
Aurora Software Associates.....	100
Beta Computer Devices.....	103
Broderbund Software.....	94
Central Point Software.....	64
Classified Ads.....	75
Columbus Instruments.....	35
Computer Mail Order.....	15
The Computerist, Inc.....	Cover 2
Connecticut Information Systems, Co.....	28
Consumer Computers.....	76
Decision Systems.....	106
D&F Enterprises.....	111
D&N Microproducts Inc.....	112
Dosware Inc.....	31
Enclosures Group.....	110
Exatron.....	19
Fessenden Computer Service.....	103
Galfo Systems.....	64
Gimix, Inc.....	109
Hogg Laboratories.....	112
D.R. Jarvis Computing.....	95
Lazer Systems.....	2
LJK Enterprises.....	43
Logical Software, Inc.....	51
Micro Computer Industries.....	65
MICRO INK, Inc.....	24, Cover 3
Microsoft Consumer Products.....	Cover 4
MicroSoftware Systems.....	51
Micro-Ware Distributing Inc.....	82
Mittendorf Engineering.....	13
National Computer Shows.....	32
Nikrom Technical Products.....	64
Omega Software Systems, Inc.....	52
Orion Software Associates.....	111
Pegasys Systems.....	95
Perry Peripherals.....	112
Powersoft, Inc.....	85
Progressive Computing.....	41
R.C. Electronics, Inc.....	106
Rosen Grandon Associates.....	95
Sensible Software.....	96
Serendipity Systems, Inc.....	106
Skyles Electric Works.....	18, 28, 85, 105
Small Business Computer Systems.....	95
Smartware.....	31
Smoke Signal Broadcasting.....	73
Stellation Two.....	56
Technical Products.....	103
Terrapin, Inc.....	52
Unique Data Systems.....	23
Versa Computing.....	87

6800/6809 SOFTWARE CATALOG

PROGRAM	LANGUAGE	OBJECT	W/SOURCE ON DISK
X-FORTH	6809/6800		***\$149.95
Dataman	TSC XBASIC		\$149.95
Datarand	TSC XBASIC		49.95
*Bill Payer	TSC XBASIC		89.95
*Purchase Order	TSC XBASIC		49.95
*Income/Expense	TSC XBASIC		49.95
All Three	TSC XBASIC		169.95
Basic Prog. Toolkit	6809 ASMB	\$49.95	69.95
Password Protection	6809 ASMB	69.95	89.95
Extended Utilities	6809 ASMB	49.95	69.95
Job Control Prog.	6800/6809 ASMB	49.95	89.95
Esther	6800/6809 ASMB	39.95	59.95
Readtest	6800/6809 ASMB	54.95	74.95
Help	6800/6809 ASMB	29.95	49.95
Dynasoft Pascal	6809	59.95	** 89.95
Plot	TSC XBASIC		44.95
Read TRS80 Tapes	6809 ASMB		54.95
Super Sleuth	6800/6809		99.00
Z80 Super Sleuth	6800/6809		99.00
Cross Assemblers	MACROS FOR TSC 6809 ASMB		EA. 49.95
	6800/1, 6805, 6502, Z-80, 8080/5	3 for	99.95
Mailing List	TSC XBASIC/6809		99.95
Forms Display	TSC XBASIC/6809		49.95
Tabula Rasa	TSC XBASIC		100.00

** SOURCE AND REPRODUCTION LICENSE-RUNTIME ONLY.
 ***Includes everything but the core.

U.S.A. add \$2.50 for Standard UPS Shipping & Handling
 Foreign orders add 10% Surface, 20% Airmail.

Specify 5" or 8" size disk and if for 6800 or 6809 system.

OUR SOFTWARE IS  COMPATIBLE.

OS-9 VERSIONS TO COME.



FRANK HOGG LABORATORY, INC. 130 MIDTOWN PLAZA • SYRACUSE, N.Y. 13210
 (315) 474-7854

OSI COMPATIBLE HARDWARE

- IO-CA10X SERIAL PORT** \$125
ACIA based RS-232 serial printer port. DIP SWITCH selectable baud rates of 300-9600. Handshaking (CTS) input line is provided to signal the computer when the printer buffer is full. Compatible with OS-65U V1.2 and OS-65D.
- IO-CA9 PARALLEL PORT** \$175
Centronics Standard Parallel printer interface for OSI computers. The card comes complete with 10 ft. of flat ribbon cable. Compatible with OS-65D and OS-65U software.
- IO-CA9D DIABLO PARALLEL PORT** \$175
DIABLO 12 BIT WORD Parallel port for use with word processor type printers. Complete with 10 ft. cable. Compatible with OS-65U software.
- IO-LEVEL 3 MULTI-USER EXPANSION** \$450
Provides 3 printer interfaces currently supported by OSI-Serial, Centronics Parallel, Diablo Parallel. 4K of memory at D000 for Multi-user executive. 4 Port serial cluster. The LEVEL 3 card allows expansion of an OSI C3 machine up to 4 users with appropriate additional memory partitions.
- 24MEM-CM9...\$380** **16MEM-CM9...\$300** **8 MEM-CM9...\$210**
24K memory card is available at 3 different populated levels. All cards are fully socketed for 24K of memory. The card uses 2114-300ns chips. DIP SWITCH addressing is provided in the form of one 16K block and one 8K block. Also supports DIP SWITCH memory partition addressing for use in multi-user systems.
- FL470 FLOPPY DISK CONTROLLER** \$180
OSI-Type floppy disk controller and real time clock. Will Support 5 1/4" or 8", Single or double-sided drives. Requires drives with separated data and clock outputs.
- BIO-1600 BARE IO CARD** \$50
Super I/O Card. Supports 8K of 2114 memory in two DIP SWITCH addressable 4K blocks, 2 16 Bit Parallel Ports may be used as printer interfaces, 5 RS-232 Serial Ports with CTS & RTS handshaking. With manual and Molex connectors.
- BMEM-CM9 BARE MEMORY CARD** \$50
Bare 24K memory card, also supports OSI-type real time clock and floppy disk controller. With manual and Molex connectors.
- #96 PROTOTYPE CARD** \$35
Prototype board holds 96 14 or 16 pin IC's. Will also accommodate 18, 24, or 40 pin IC's. Row and column zone markings, easy layout. 1/16" epoxy glass P.C. board.
- C1P-EXP EXPANSION INTERFACE** \$65
Expansion for C1P 600 or 610 boards to the OSI 48 Pin Buss. Uses expansion socket and interface circuitry to expand to 48 Pin Backplane. Requires one slot in backplane.
- BP-580 BACKPLANE** \$47
Assembled 8-slot backplane with male Molex connectors and termination resistors.
- DSK-SW DISK SWITCH** \$29
A circuit when added to OSI Minifloppy systems extends the life of drives and media. Accomplish this by shutting off Minifloppy Spindle motor when system is not accessing the drive. Complete KIT and manual.
- PW-5-6 POWER SUPPLY** \$29
Power One brand supply 5V - 6 amps with overvoltage protection. Reg. \$49.95.

D&N MICRO PRODUCTS, INC.

3684 N. Wells Street Ft. Wayne, Indiana 46808
 219/485-6414

TERMS: Check or money order Add \$2 Shipping, Outside U.S. add 10%.

K I M A I M S Y M T I M

END FRUSTRATION!!

FROM CASSETTE FAILURES
 PERRY PERIPHERALS HAS
 THE HDE SOLUTION
 OMNIDISK SYSTEMS (5" and 8")

ACCLAIMED HDE SOFTWARE

- Assembler, Dynamic Debugging Tool, Text Output Processor, Comprehensive Memory Test
 - HDE DISK BASIC NOW AVAILABLE
- PERRY PERIPHERALS S-100 PACKAGE

Adds Omnidisk (5") to
 Your KIM/S-100 System

- Construction Manual—No Parts
- FODS & TED Diskette
- \$20. +\$2. postage & handling. (NY residents add 7% tax) (specify for 1 or 2 drive system)

Place your order with:
PERRY PERIPHERALS
 P.O. Box 924
 Miller Place, N.Y. 11764
 (516) 744-6462

Your Full-Line HDE Distributor/Exporter

VIGIL

INTERACTIVE GRAPHICS/GAME LANGUAGE
 FOR THE PET/CBM



VIGIL is an exciting new interactive language for your PET/CBM micro. VIGIL - Video Interactive Game Interpretive Language - is an easy to learn graphics and game language that lets you quickly create interactive applications.

- More than 60 powerful commands permit you to easily manipulate graphics figures on the screen
- Double density graphics give you 80 X 50 plot positions on your 40 column PET/CBM
- Large number display capability, access to two event timers and tone generation (if you have ext. speaker)
- Load and save your VIGIL programs to cassette or diskette
- Nine interactive programs demonstrate the power of VIGIL - Breakout, SpaceWar, AntiAircraft, U.F.O., SpaceBattle, Concentration, Maze, Kaleidoscope & Fortune
- Comprehensive user's manual with complete listings of enclosed programs

VIGIL comes on cassette, or diskette ready to run on any 40 column PET/CBM micro with at least 8K of memory. Specify ROM-set when ordering. 6502 listing of the VIGIL Interpreter available separately.

	US & Canada	Foreign
VIGIL For Pet/CBM on Cassette or Diskette (w/9 programs)	\$35	\$40
VIGIL User's Manual (refundable with software)	\$10	\$12
VIGIL Interpreter listing (6502 Assembly language)	\$25	\$30
PET MACHINE LANGUAGE GUIDE	\$8	\$10



ABACUS SOFTWARE
 P.O. Box 7211
 Grand Rapids, Michigan 49510
 (616) 241-5510



Prices include postage. Michigan residents include 4% sales tax. Orders must be prepaid or via bankcard (Mastercard, VISA, Eurocard, Access, etc.). Include card number and expiration date.

(C) 1981 by Roy Wainwright

GET MORE OUT OF YOUR APPLE WITH MICRO^{on}_{the} APPLE

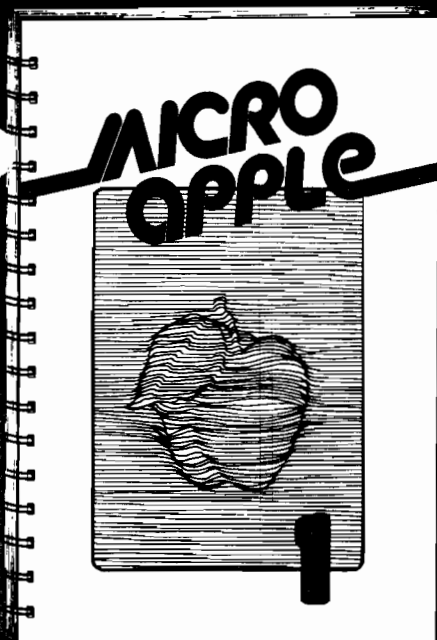

MICRO/Apple

Over 30 Apple Programs on Diskette — For
Less Than \$1.00 Apiece! No Need to Type
In Hundreds of Lines of Code!

224-page book and diskette

\$24.95*

Add \$2.00 for surface
shipping. Massachusetts
residents add 5% for
sales tax.

MICRO's new book for Apple II users lets you

- Speed up programming in Applesoft and Integer BASIC!
- Add Apple II Plus editing features — at no cost!
- Round and format numbers accurately in business applications!
- Get lowercase letters and punctuation into Applesoft strings — at no cost!
- Do a shape table easily and correctly!
- Play the hit game "Spelunker"!
- And much, much more!

With MICRO/Apple 1, the first volume in our new series, you receive

- 30 choice articles from MICRO (1977-80), complete with listings, all updated by the authors or MICRO staff,

plus

- 38 tested programs on diskette (13 sector, 3.2 DOS format, convertible to 3.3).

Ask for MICRO/Apple at your computer store or

Call Toll-free 800-227-1617, Ext. 564

In California, call 800-772-3545, Ext. 564

VISA and Mastercard Accepted

MICRO

34 Chelmsford Street

P.O. Box 6502

Chelmsford, Massachusetts 01824



Turn your Apple into the world's most versatile personal computer.

The SoftCard™ Solution. SoftCard turns your Apple into two computers. A Z-80 and a 6502. By adding a Z-80 microprocessor and CP/M to your Apple, SoftCard turns your Apple into a CP/M based machine. That means you can access the single largest body of microcomputer software in existence. Two computers in one. And, the advantages of both.

Plug and go. The SoftCard system starts with a Z-80 based circuit card. Just plug it into any slot (except 0) of your Apple. No modifications required. SoftCard supports most of your Apple peripherals, and, in 6502-mode, your Apple is still your Apple.

CP/M for your Apple You get CP/M on disk with the SoftCard package. It's a powerful and simple-to-use operating system. It supports more software than any other microcomputer operating system. And that's the key to the versatility of the SoftCard/Apple.

BASIC included. A powerful tool, BASIC-80 is included in the SoftCard package. Running under CP/M, ANSI Standard BASIC-80 is the most powerful microcomputer BASIC available. It includes extensive disk I/O statements, error trapping, integer variables, 16-digit precision, extensive EDIT commands and string functions, high and low-res Apple graphics, PRINT USING, CHAIN and COMMON, plus many additional commands. And, it's a BASIC you can compile with Microsoft's BASIC Compiler.

More languages. With SoftCard and CP/M, you can add Microsoft's ANSI Standard COBOL, and FORTRAN, or

Basic Compiler and Assembly Language Development System. All, more powerful tools for your Apple.

Seeing is believing. See the SoftCard in operation at your Microsoft or Apple dealer. We think you'll agree that the SoftCard turns your Apple into the world's most versatile personal computer.

Complete information? It's at your dealer's now. Or, we'll send it to you and include a dealer list. Write us. Call us.

SoftCard is a trademark of Microsoft. Apple II and Apple II Plus are registered trademarks of Apple Computer. Z-80 is a registered trademark of Zilog, Inc. CP/M is a registered trademark of Digital Research, Inc.

MICROSOFT

CONSUMER PRODUCTS

Microsoft Consumer Products, 400 108th Ave. N.E.,
Bellevue, WA 98004. (206) 454-1315